

# 2018 **SUPER DUTY** Owner's Manual



owner.ford.com



ford.ca

Owner's Manual

January 2018  
Second Printing  
Owner's Manual  
Super Duty  
Litho in U.S.A.



JC3J19A321 AA



The information contained in this publication was correct at the time of going to print. In the interest of continuous development, we reserve the right to change specifications, design or equipment at any time without notice or obligation. No part of this publication may be reproduced, transmitted, stored in a retrieval system or translated into any language in any form by any means without our written permission. Errors and omissions excepted.

© Ford Motor Company 2017

All rights reserved.

Part Number: 201709 20171220012136



# Table of Contents

---

## Introduction

About This Manual .....	7
Symbols Glossary .....	8
Data Recording .....	10
California Proposition 65 .....	12
Perchlorate .....	12
Ford Credit .....	12
Replacement Parts Recommendation .....	12
Special Notices .....	13
Mobile Communications Equipment .....	14
Export Unique Options .....	15

## Environment

Protecting the Environment .....	16
----------------------------------	----

## At a Glance

Instrument Panel Overview .....	17
---------------------------------	----

## Child Safety

General Information .....	19
Installing Child Restraints .....	20
Booster Seats .....	32
Child Restraint Positioning .....	34
Child Safety Locks .....	35

## Seatbelts

Principle of Operation .....	37
Fastening the Seatbelts .....	38
Seatbelt Height Adjustment .....	42
Seatbelt Warning Lamp and Indicator Chime .....	42
Seatbelt Reminder .....	43
Child Restraint and Seatbelt Maintenance .....	44
Seatbelt Extension .....	45

## Supplementary Restraints System

Principle of Operation .....	46
Driver and Passenger Airbags .....	47
Side Airbags .....	52
Safety Canopy™ .....	53
Crash Sensors and Airbag Indicator .....	54
Airbag Disposal .....	55

## Keys and Remote Controls

General Information on Radio Frequencies .....	56
Remote Control .....	56
Replacing a Lost Key or Remote Control .....	62

## MyKey™

Principle of Operation .....	63
Creating a MyKey .....	64
Clearing All MyKeys .....	65
Checking MyKey System Status .....	65
Using MyKey With Remote Start Systems .....	65
MyKey Troubleshooting .....	65

## Doors and Locks

Locking and Unlocking .....	67
Keyless Entry .....	70

## Tailgate

Tailgate Lock .....	72
Removing the Tailgate .....	72
Tailgate Step .....	73
Bed Extender .....	74

## Security

Passive Anti-Theft System .....	76
Anti-Theft Alarm .....	78

# Table of Contents

---

## Power Running Boards

Using Power Running Boards .....	80
----------------------------------	----

## Steering Wheel

Adjusting the Steering Wheel - Vehicles With: Manual Adjustable Steering Column .....	82
Adjusting the Steering Wheel - Vehicles With: Power Adjustable Steering Column .....	82
Audio Control .....	83
Voice Control .....	84
Cruise Control .....	84
Information Display Control .....	85
Heated Steering Wheel .....	85

## Pedals

Adjusting the Pedals .....	86
----------------------------	----

## Wipers and Washers

Windshield Wipers .....	87
Autowipers .....	87
Windshield Washers .....	88

## Lighting

General Information .....	89
Lighting Control .....	89
Autolamps .....	90
Instrument Lighting Dimmer .....	90
Daytime Running Lamps .....	91
Automatic High Beam Control .....	92
Front Fog Lamps .....	93
Direction Indicators .....	93
Spot Lamps .....	93
Interior Lamps .....	94
Ambient Lighting .....	97
Cargo Lamps .....	97

## Windows and Mirrors

Power Windows .....	98
---------------------	----

Global Opening .....	99
Exterior Mirrors .....	99
Interior Mirror .....	101
Sliding Windows .....	102
Sun Visors .....	102
Moonroof .....	103

## Instrument Cluster

Gauges .....	105
Warning Lamps and Indicators .....	108
Audible Warnings and Indicators .....	112

## Information Displays

General Information .....	113
Information Messages .....	129

## Climate Control

Manual Climate Control .....	146
Automatic Climate Control .....	147
Hints on Controlling the Interior Climate .....	149
Heated Rear Window .....	152
Heated Exterior Mirrors .....	152
Cabin Air Filter .....	152
Remote Start .....	152

## Seats

Sitting in the Correct Position .....	154
Head Restraints .....	154
Manual Seats .....	156
Power Seats .....	157
Memory Function .....	159
Rear Seats .....	161
Heated Seats .....	162
Climate Controlled Seats .....	163
Front Seat Armrest .....	164
Rear Seat Armrest .....	165

# Table of Contents

---

## Universal Garage Door Opener

Universal Garage Door Opener .....	166
------------------------------------	-----

## Auxiliary Power Points

Auxiliary Power Points .....	170
------------------------------	-----

## Storage Compartments

Center Console .....	172
Overhead Console .....	172
Under Seat Storage .....	172

## Starting and Stopping the Engine

General Information .....	175
Ignition Switch .....	175
Keyless Starting .....	176
Starting a Gasoline Engine - 6.2L/6.8L .....	176
Starting a Diesel Engine - 6.7L Diesel .....	178
Switching Off the Engine - 6.7L Diesel .....	183
Engine Idle Shutdown .....	183
Engine Block Heater .....	183

## Fuel and Refueling

Safety Precautions .....	185
Fuel Quality - E85 .....	186
Fuel Quality - Diesel .....	187
Fuel Quality - Gasoline .....	189
Running Out of Fuel .....	190
Refueling - Gasoline .....	190
Refueling - Diesel .....	191
Fuel Consumption .....	193

## Engine Emission Control

Emission Law .....	195
Catalytic Converter .....	196

Selective Catalytic Reductant System - Diesel .....	198
Diesel Particulate Filter .....	202

## Transmission

Automatic Transmission .....	208
Power Take-Off .....	213

## Four-Wheel Drive

Using Four-Wheel Drive .....	214
------------------------------	-----

## Rear Axle

Limited Slip Differential .....	223
Electronic Locking Differential .....	223

## Brakes

General Information .....	225
Hints on Driving With Anti-Lock Brakes .....	227
Parking Brake .....	227
Hill Start Assist .....	227

## Traction Control

Principle of Operation .....	229
Using Traction Control .....	229

## Stability Control

Principle of Operation .....	230
Using Stability Control .....	231

## Terrain Control

Principle of Operation .....	233
Using Hill Descent Control .....	233

## Parking Aids

Principle of Operation .....	235
Rear Parking Aid .....	235
Rear View Camera .....	236
360 Degree Camera .....	239

# Table of Contents

---

## Cruise Control

Principle of Operation .....	243
Using Cruise Control .....	243
Using Adaptive Cruise Control .....	244

## Driving Aids

Lane Keeping System .....	250
Blind Spot Information System .....	252
Cross Traffic Alert .....	257
Steering .....	259
Collision Warning System .....	261

## Load Carrying

Load Limit .....	264
Bed Ramps .....	268

## Towing

Towing a Trailer .....	272
Trailer Reversing Aids .....	274
Trailer Sway Control .....	281
Recommended Towing Weights .....	282
Essential Towing Checks .....	286
Towing the Vehicle on Four Wheels .....	295

## Driving Hints

Breaking-In .....	298
Economical Driving .....	298
Driving Through Water .....	299
Floor Mats .....	299
Snowplowing .....	300

## Roadside Emergencies

Roadside Assistance .....	303
Hazard Flashers .....	304
Fuel Shutoff .....	304
Jump Starting the Vehicle .....	305
Post-Crash Alert System .....	307
Transporting the Vehicle .....	307
Towing Points .....	308

## Customer Assistance

Getting the Services You Need .....	310
In California (U.S. Only) .....	311
The Better Business Bureau (BBB) Auto Line Program (U.S. Only) .....	312
Utilizing the Mediation/Arbitration Program (Canada Only) .....	313
Getting Assistance Outside the U.S. and Canada .....	313
Ordering Additional Owner's Literature .....	314
Reporting Safety Defects (U.S. Only) .....	315
Reporting Safety Defects (Canada Only) .....	315

## Fuses

Fuse Specification Chart .....	317
Changing a Fuse .....	326

## Maintenance

General Information .....	328
Opening and Closing the Hood .....	328
Under Hood Overview - 6.2L .....	329
Under Hood Overview - 6.7L Diesel .....	330
Under Hood Overview - 6.8L .....	331
Engine Oil Dipstick - 6.2L/6.8L .....	333
Engine Oil Dipstick - 6.7L Diesel .....	333
Engine Oil Check - 6.2L/6.8L .....	333
Engine Oil Check - 6.7L Diesel .....	334
Changing the Engine Oil and Oil Filter .....	335
Changing the Crankcase Vent Filter Element .....	336
Oil Change Indicator Reset .....	337
Engine Coolant Check - 6.2L/6.8L .....	338
Engine Coolant Check - 6.7L Diesel .....	342
Automatic Transmission Fluid Check .....	346
Transfer Case Fluid Check .....	349
Brake Fluid Check .....	349

# Table of Contents

Power Steering Fluid Check .....	350	Changing a Road Wheel .....	408
Washer Fluid Check .....	350	Technical Specifications .....	418
Draining the Fuel Filter Water Trap - 6.7L Diesel .....	351	<b>Capacities and Specifications</b>	
Fuel Filter - 6.2L/6.8L .....	352	Engine Specifications - 6.2L .....	420
Changing the 12V Battery .....	353	Engine Specifications - 6.7L Diesel .....	420
Checking the Wiper Blades .....	355	Engine Specifications - 6.8L .....	421
Changing the Wiper Blades .....	355	Motorcraft Parts - 6.2L .....	422
Adjusting the Headlamps .....	355	Motorcraft Parts - 6.7L Diesel .....	423
Changing a Bulb .....	357	Motorcraft Parts - 6.8L .....	424
Bulb Specification Chart .....	360	Vehicle Identification Number .....	425
Changing the Engine Air Filter - 6.2L/6.8L .....	362	Vehicle Certification Label .....	426
Changing the Engine Air Filter - 6.7L Diesel .....	363	Transmission Code Designation .....	426
Changing the Engine-Mounted and Diesel Fuel Conditioner Module Fuel Filters - 6.7L Diesel .....	365	Capacities and Specifications - 6.2L .....	427
<b>Vehicle Care</b>		Capacities and Specifications - 6.7L Diesel .....	432
General Information .....	370	Capacities and Specifications - 6.8L .....	439
Cleaning Products .....	370	<b>Audio System</b>	
Cleaning the Exterior .....	370	General Information .....	445
Waxing .....	371	Audio Unit - Vehicles With: AM/FM .....	446
Cleaning the Engine .....	372	Audio Unit - Vehicles With: AM/FM/CD/ SYNC .....	448
Cleaning the Exhaust - 6.7L Diesel .....	372	Audio Unit - Vehicles With: AM/FM/CD/ Touchscreen Display .....	453
Cleaning the Windows and Wiper Blades .....	373	Digital Radio .....	454
Cleaning the Interior .....	373	Satellite Radio .....	456
Cleaning the Instrument Panel and Instrument Cluster Lens .....	375	USB Port .....	459
Cleaning Leather Seats .....	375	<b>SYNC™</b>	
Repairing Minor Paint Damage .....	377	General Information .....	460
Cleaning the Wheels .....	377	Using Voice Recognition .....	462
Vehicle Storage .....	377	Using SYNC™ With Your Phone .....	464
<b>Wheels and Tires</b>		SYNC™ Applications and Services .....	476
General Information .....	380	Using SYNC™ With Your Media Player .....	481
Tire Care .....	382	SYNC™ Troubleshooting .....	490
Using Snow Chains .....	400		
Tire Pressure Monitoring System .....	400		



# Table of Contents

---

## **SYNC™ 3**

General Information .....	498
Home Screen .....	509
Using Voice Recognition .....	510
Entertainment .....	517
Climate .....	527
Phone .....	529
Navigation .....	535
Apps .....	543
Settings .....	546
SYNC™ 3 Troubleshooting .....	560

## **Accessories**

Accessories .....	574
Auxiliary Switches .....	575

## **Ford Protect**

Ford Protect .....	579
--------------------	-----

## **Scheduled Maintenance**

General Maintenance Information .....	581
Normal Scheduled Maintenance .....	584
Special Operating Conditions Scheduled Maintenance .....	589
Scheduled Maintenance Record .....	598

## **Appendices**

Electromagnetic Compatibility .....	609
End User License Agreement .....	611
Type Approvals .....	637

# Introduction

---

## ABOUT THIS MANUAL

Thank you for choosing Ford. We recommend that you take some time to get to know your vehicle by reading this manual. The more that you know about your vehicle, the greater the safety and pleasure you will get from driving it.

### WARNING



Driving while distracted can result in loss of vehicle control, crash and injury. We strongly recommend that you use extreme caution when using any device that may take your focus off the road. Your primary responsibility is the safe operation of your vehicle. We recommend against the use of any hand-held device while driving and encourage the use of voice-operated systems when possible. Make sure you are aware of all applicable local laws that may affect the use of electronic devices while driving.

---

**Note:** *This manual describes product features and options available throughout the range of available models, sometimes even before they are generally available. It may describe options that are not on your vehicle. It is possible that either Ford Motor Company or an authorized Ford dealer may have originally sold an incomplete vehicle to a vehicle modifier who upfitted it. As a result, some of the options and features on this vehicle may differ from what we describe in this manual.*

**Note:** *Some of the illustrations in this manual may show features as used in different models, so they may appear differently to you on your vehicle.*

**Note:** *Always use and operate your vehicle in line with all applicable laws and regulations.*

**Note:** *Pass on this manual when selling your vehicle. It is an integral part of the vehicle.*

**Note:** *Your vehicle's powertrain control systems can detect and store information about vehicle modifications that increase horsepower and torque output such as whether or not performance-enhancing powertrain components commonly referred to as performance chips have been used. This information will stay in the system's memory and cannot be erased even if the modification is removed. Ford Motor Company, Ford of Canada, Ford of Mexico and service or repair facilities can retrieve this information when servicing your vehicle. Ford Motor Company may use this information to determine if your warranty covers any needed repairs.*

**Note:** *Some aftermarket products may cause severe engine, transmission and exhaust system damage. See your warranty information for more details.*

Your new diesel engine may feel, drive and function somewhat differently than a gasoline engine. Therefore, it is very important that you read and thoroughly familiarize yourself and others operating the vehicle with this guide. There is a special procedure for turning off the diesel engine. See **Starting a Diesel Engine** (page 178). It is important to read and understand this material in order to maintain the best service life for your engine.

Ford may discontinue models or change specifications without any notice and without incurring obligations.

This manual may qualify the location of a component as left-hand side or right-hand side. The side is determined when facing forward in the seat.

# Introduction



E154903

A Right-hand side

B Left-hand side

**Note:** Throughout this guide, you will find warnings identified by the warning symbol. Warnings remind you to be especially careful to reduce the risk of personal injury.

## SYMBOLS GLOSSARY

These are some of the symbols you may see on your vehicle.



Air conditioning system



Air conditioning system lubricant type



Anti-lock braking system



Avoid smoking, flames or sparks



Battery



Battery acid



Brake fluid - non petroleum based



Brake system



Cabin air filter



Check fuel cap



Child safety door lock or unlock



Child seat lower anchor



Child seat tether anchor



Cruise control



Do not open when hot



Engine air filter



Engine coolant



Engine coolant temperature



Engine oil



Explosive gas

# Introduction



Fan warning



Fasten seatbelt



Flammable



Front airbag



Front fog lamps



Fuel pump reset



Fuse compartment



Hazard flashers



Heated rear window



Windshield defrosting system



Interior luggage compartment release



Jack



Keep out of reach of children



Lighting control



Low tire pressure warning



Maintain correct fluid level



Note operating instructions



Horn control



Panic alarm



Parking aid



Parking brake



Power steering fluid



Power windows front/rear



Power window lockout



Requires registered technician



Safety alert



See Owner's Manual



See Service Manual



Service engine soon



Passenger airbag activated

# Introduction



Passenger airbag deactivated



Side airbag



Shield the eyes



Stability control



Windshield wiper system



Windshield wash and wipe

## DATA RECORDING

### Service Data Recording

Service data recorders in your vehicle are capable of collecting and storing diagnostic information about your vehicle. This potentially includes information about the performance or status of various systems and modules in the vehicle, such as engine, throttle, steering or brake systems. In order to properly diagnose and service your vehicle, Ford Motor Company (Ford of Canada in Canada), and service and repair facilities may access or share among them vehicle diagnostic information received through a direct connection to your vehicle when diagnosing or servicing your vehicle. Additionally, Ford Motor Company (Ford of Canada, in Canada) may, where permitted by law, use vehicle diagnostic information for vehicle improvement or with other information we may have about you, (for example, your contact information), to offer you products or services that may interest you. Data may be provided to our service providers such

as part suppliers that may help diagnose malfunctions, and who are similarly obligated to protect data. We retain this data only as long as necessary to perform these functions or to comply with law. We may provide information where required in response to official requests to law enforcement or other government authorities or third parties acting with lawful authority or court order, and such information may be used in legal proceedings. For U.S. only (if equipped), if you choose to use connected apps and services, such as SYNC Vehicle Health Report or MyFord Mobile App, you consent that certain diagnostic information may also be accessed electronically by Ford Motor Company and Ford authorized service facilities, and that the diagnostic information may be used to provide services to you, personalizing your experience, troubleshoot, and to improve products and services and offer you products and services that may interest you, where permitted by law. For Canada only, for more information, please review the Ford of Canada privacy policy at [www.ford.ca](http://www.ford.ca), including our U.S. data storage and use of service providers in other jurisdictions who may be subject to legal requirements in Canada, the United States and other countries applicable to them, for example, lawful requirements to disclose personal information to governmental authorities in those countries. See **SYNC™** (page 460).

### Event Data Recording

**This vehicle is equipped with an event data recorder. The main purpose of an event data recorder is to record, in certain crash or near crash-like situations, such as an airbag deployment or hitting a road obstacle;**

# Introduction

---

this data will assist in understanding how a vehicle's systems performed. The event data recorder is designed to record data related to vehicle dynamics and safety systems for a short period of time, typically 30 seconds or less.

The event data recorder in this vehicle is designed to record such data as:

- How various systems in your vehicle were operating;
- Whether or not the driver and passenger safety belts were buckled/fastened;
- How far (if at all) the driver was depressing the accelerator and/or the brake pedal; and
- How fast the vehicle was traveling; and
- Where the driver was positioning the steering wheel.

This data can help provide a better understanding of the circumstances in which crashes and injuries occur.

**Note:** Event data recorder data is recorded by your vehicle only if a non-trivial crash situation occurs; no data is recorded by the event data recorder under normal driving conditions and no personal data or information (e.g., name, gender, age, and crash location) is recorded (see limitations regarding 911 Assist and Traffic, directions and Information privacy below). However, parties, such as law enforcement, could combine the event data recorder data with the type of personally identifying data routinely acquired during a crash investigation.

To read data recorded by an event data recorder, special equipment is required, and access to the vehicle or the event data recorder is needed. In addition to the vehicle manufacturer, other parties, such as law enforcement, that have such special equipment, can read

the information if they have access to the vehicle or the event data recorder. Ford Motor Company and Ford of Canada do not access event data recorder information without obtaining consent, unless pursuant to court order or where required by law enforcement, other government authorities or other third parties acting with lawful authority. Other parties may seek to access the information independently of Ford Motor Company and Ford of Canada.

**Note:** Including to the extent that any law pertaining to Event Data Recorders applies to SYNC or its features, please note the following: Once 911 Assist (if equipped) is enabled (set ON), 911 Assist may, through any paired and connected cell phone, disclose to emergency services that the vehicle has been in a crash involving the deployment of an airbag or, in certain vehicles, the activation of the fuel pump shut-off. Certain versions or updates to 911 Assist may also be capable of being used to electronically or verbally provide to 911 operators the vehicle location (such as latitude and longitude), and/or other details about the vehicle or crash or personal information about the occupants to assist 911 operators to provide the most appropriate emergency services. If you do not want to disclose this information, do not activate the 911 Assist feature. See SYNC™ (page 460).

Additionally, when you connect to Traffic, Directions and Information (if equipped, U.S. only), the service uses GPS technology and advanced vehicle sensors to collect the vehicle's current location, travel direction, and speed ("vehicle travel information"), only to help provide you with the directions, traffic reports, or business searches that you request. If you do not want

# Introduction

**Ford or its vendors to receive this information, do not activate the service. For more information, see Traffic, Directions and Information, Terms and Conditions.** See SYNC™ (page 460).

## CALIFORNIA PROPOSITION 65

### WARNINGS



Some constituents of engine exhaust, certain vehicle components, certain fluids contained in vehicles and certain products of component wear contain or emit chemicals known to the State of California to cause cancer and birth defects or other reproductive harm.



Battery posts, terminals and related accessories contain lead and lead compounds, chemicals known to the State of California to cause cancer and reproductive harm. Batteries also contain other chemicals known to the State of California to cause cancer. Wash your hands after handling.

## PERCHLORATE

Certain components in your vehicle such as airbag modules, seatbelt pretensioners and remote control batteries may contain perchlorate material. Special handling may apply for service or vehicle end of life disposal.

**For more information visit:**

Web Address
<a href="http://www.dtscc.ca.gov/hazardouswaste/perchlorate">www.dtscc.ca.gov/hazardouswaste/perchlorate</a>

## FORD CREDIT

### US Only

Ford Credit offers a full range of financing and lease plans to help you acquire your vehicle. If you have financed or leased your vehicle through Ford Credit, thank you for your business.

We offer a number of convenient ways for you to contact us, and to manage your account.

Call 1-800-727-7000.

For more information about Ford Credit and access to Account Manager, go to [www.ford.com/finance](http://www.ford.com/finance).

## REPLACEMENT PARTS RECOMMENDATION

We have built your vehicle to the highest standards using quality parts. We recommend that you demand the use of genuine Ford and Motorcraft parts whenever your vehicle requires scheduled maintenance or repair. You can clearly identify genuine Ford and Motorcraft parts by looking for the Ford, FoMoCo or Motorcraft branding on the parts or their packaging.

# Introduction

---

## Scheduled Maintenance and Mechanical Repairs

One of the best ways for you to make sure that your vehicle provides years of service is to have it maintained in line with our recommendations using parts that conform to the specifications detailed in this Owner's Manual. Genuine Ford and Motorcraft parts meet or exceed these specifications.

## Collision Repairs

We hope that you never experience a collision, but accidents do happen. Genuine Ford replacement collision parts meet our stringent requirements for fit, finish, structural integrity, corrosion protection and dent resistance. During vehicle development we validate that these parts deliver the intended level of protection as a whole system. A great way to know for sure you are getting this level of protection is to use genuine Ford replacement collision parts.

## Warranty on Replacement Parts

Genuine Ford and Motorcraft replacement parts are the only replacement parts that benefit from a Ford Warranty. The Ford Warranty may not cover damage caused to your vehicle as a result of failed non-Ford parts. For additional information, refer to the terms and conditions of the Ford Warranty.

## SPECIAL NOTICES

### New Vehicle Limited Warranty

For a detailed description of what is covered and what is not covered by your vehicle's New Vehicle Limited Warranty, see the Warranty Guide that is provided to you along with your Owner's Manual.

## Special Instructions

For your added safety, your vehicle has sophisticated electronic controls.

### WARNINGS



You risk death or serious injury to yourself and others if you do not follow the instruction highlighted by the warning symbol. Failure to follow the specific warnings and instructions could result in personal injury.



**Never** place front seat mounted rear-facing child or infant seats in front of an active passenger airbag.

## On Board Diagnostics Data Link Connector

### WARNING



Do not connect wireless plug-in devices to the data link connector. Unauthorized third parties could gain access to vehicle data and impair the performance of safety related systems. Only allow repair facilities that follow our service and repair instructions to connect their equipment to the data link connector.

Your vehicle has an OBD Data Link Connector (DLC) that is used in conjunction with a diagnostic scan tool for vehicle diagnostics, repairs and reprogramming services. Installing an aftermarket device that uses the DLC during normal driving for purposes such as remote insurance company monitoring, transmission of vehicle data to other devices or entities, or altering the performance of the vehicle, may cause interference with or even damage to vehicle systems. We do not recommend or endorse the use of aftermarket plug-in devices unless approved by Ford. The vehicle Warranty will not cover damage caused by an aftermarket plug-in device.



# Introduction

---

## Using your Vehicle With a Snowplow

More information and guidelines for using your vehicle with a snowplow are in this Owner's Manual. See **Snowplowing** (page 300).

## Using a Slide-In Camper

For information regarding the use of slide-in campers, consult the Truck Camper Loading document supplied with your vehicle.

## Using your Vehicle as an Ambulance

If your light truck has the Ford Ambulance Preparation Package, it may be utilized as an ambulance. We urge ambulance manufacturers to follow the recommendations of the Ford Incomplete Vehicle Manual, Ford Truck Body Builder's Layout Book and the Qualified Vehicle Modifiers (QVM) Guidelines as well as pertinent supplements. For additional information, please contact the Truck Body Builders Advisory Service at <http://www.fleet.ford.com/truckbbas/> and then by selecting Contact Us or by phone at 1-877-840-4338.

Use of your Ford light truck as an ambulance, without the Ford Ambulance Preparation Package voids the Ford New Vehicle Limited Warranty and may void the emissions warranties. In addition, ambulance usage without the preparation package could cause high underbody temperatures, overpressurized fuel and a risk of spraying fuel which could lead to fires.

If your vehicle has the Ford Ambulance Preparation Package, it will be indicated on the Safety Compliance Certification Label. The label is on the driver side door pillar or on the rear edge of the driver door. You can determine whether the ambulance manufacturer followed Ford's recommendations by directly contacting that manufacturer. The Ford Ambulance Preparation Package is only available on certain diesel engine equipped vehicles.

## Using your Vehicle as a Stationary Power Source

Information and guidelines for operating a vehicle with an aftermarket power take-off system are in this Owner's Manual. See **Power Take-Off** (page 213).

## MOBILE COMMUNICATIONS EQUIPMENT

### WARNING



Driving while distracted can result in loss of vehicle control, crash and injury. We strongly recommend that you use extreme caution when using any device that may take your focus off the road. Your primary responsibility is the safe operation of your vehicle. We recommend against the use of any hand-held device while driving and encourage the use of voice-operated systems when possible. Make sure you are aware of all applicable local laws that may affect the use of electronic devices while driving.

Using mobile communications equipment is becoming increasingly important in the conduct of business and personal affairs. However, you must not compromise your own or others' safety when using such equipment. Mobile communications can enhance personal safety and security when appropriately used, particularly in

# Introduction

---

emergency situations. Safety must be paramount when using mobile communications equipment to avoid negating these benefits. Mobile communication equipment includes, but is not limited to, cellular phones, pagers, portable email devices, text messaging devices and portable two-way radios.

## EXPORT UNIQUE OPTIONS

For your particular global region, your vehicle may be equipped with features and options that are different from the features and options that are described in this Owner's Manual. A market unique supplement may be supplied that complements this book. By referring to the market unique supplement, if provided, you can properly identify those features, recommendations and specifications that are unique to your vehicle. This Owner's Manual is written primarily for the U.S. and Canadian Markets. Features or equipment listed as standard may be different on units built for export. **Refer to this Owner's Manual for all other required information and warnings.**

# Environment

---

## **PROTECTING THE ENVIRONMENT**

You should play your part in protecting the environment. Correct vehicle usage and the authorized disposal of waste, cleaning and lubrication materials are significant steps toward this aim.

**For details about Ford Motor Company's sustainability progress and initiatives visit:**

<b>Web Address</b>
<a href="http://www.sustainability.ford.com">www.sustainability.ford.com</a>

# At a Glance

## INSTRUMENT PANEL OVERVIEW

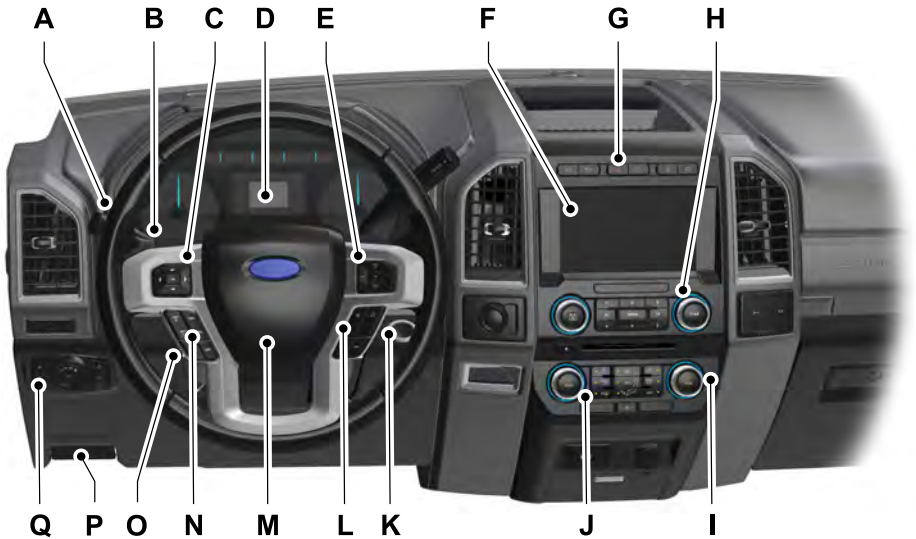

E251634

- A Direction indicators. See **Direction Indicators** (page 93).
- B Wiper lever. See **Wipers and Washers** (page 87).
- C Information display controls. See **Information Displays** (page 113).
- D Instrument cluster. See **Instrument Cluster** (page 105).
- E Navigation, media, phone.
- F Entertainment display.
- G Hazard flasher switch. See **Hazard Flashers** (page 304).

- H Audio. See **Audio System** (page 445).
- I Climate control. See **Climate Control** (page 146).
- J Rear defrost.
- K Start button. See **Keyless Starting** (page 176).
- L Voice control. See **Voice Control** (page 84).
- M Horn.
- N Cruise control. See **Cruise Control** (page 243).
- O Steering wheel adjustment. See **Adjusting the Steering Wheel** (page 82).

## At a Glance

---

- P Parking brake release. See **Brakes** (page 225).
- Q Lighting control. See **Lighting Control** (page 89).

# Child Safety

## GENERAL INFORMATION

See the following sections for directions on how to properly use safety restraints for children.

### WARNINGS



Always make sure your child is secured properly in a device that is appropriate for their height, age and weight. Child safety restraints must be bought separately from your vehicle. Failure to follow these instructions and guidelines may result in an increased risk of serious injury or death to your child.



All children are shaped differently. The National Highway Traffic Safety Administration and other safety organizations, base their recommendations for child restraints on probable child height, age and weight thresholds, or on the minimum requirements of the law. We recommend that you check with a NHTSA Certified Child Passenger Safety

### WARNINGS

Technician (CPST) to make sure that you properly install the child restraint in your vehicle and that you consult your pediatrician to make sure you have a child restraint appropriate for your child. To locate a child restraint fitting station and CPST, contact NHTSA toll free at 1-888-327-4236 or go to [www.nhtsa.dot.gov](http://www.nhtsa.dot.gov). In Canada, contact Transport Canada toll free at 1-800-333-0371 or go to [www.tc.gc.ca](http://www.tc.gc.ca) to find a Child Car Seat Clinic in your area. Failure to properly restrain children in child restraints made especially for their height, age and weight, may result in an increased risk of serious injury or death to your child.



On hot days, the temperature inside the vehicle can rise very quickly. Exposure of people or animals to these high temperatures for even a short time can cause death or serious heat related injuries, including brain damage. Small children are particularly at risk.

# Child Safety

## Recommendations for Safety Restraints for Children

Child	Child size, height, weight, or age	Recommended restraint type
Infants or toddlers	Children weighing 40 lb (18 kg) or less (generally age four or younger).	Use a child safety seat (sometimes called an infant carrier, convertible seat, or toddler seat).
Small children	Children who have outgrown or no longer properly fit in a child safety seat (generally children who are less than 4 ft. 9 in. (1.45 m) tall, are greater than age four and less than age 12, and between 40 lb (18 kg) and 80 lb (36 kg) and upward to 100 lb (45 kg) if recommended by your child restraint manufacturer).	Use a belt-positioning booster seat.
Larger children	Children who have outgrown or no longer properly fit in a belt-positioning booster seat (generally children who are at least 4 ft. 9 in. (1.45 m) tall or greater than 80 lb (36 kg) or 100 lb (45 kg) if recommended by child restraint manufacturer).	Use a vehicle seatbelt having the lap belt snug and low across the hips, shoulder belt centered across the shoulder and chest, and seatback upright.

- You are required by law to properly use safety seats for infants and toddlers in the United States and Canada.
- Many states and provinces require that small children use approved booster seats until they reach age eight, a height of 4 feet 9 inches (1.45 meters) tall, or 80 lb (36 kg). Check your local and state or provincial laws for specific requirements about the safety of children in your vehicle.
- When possible, always properly restrain children 12 years of age and under in a rear seating position of your vehicle. Accident statistics suggest that children are safer when properly restrained in the rear seating positions than in a front seating position.

## INSTALLING CHILD RESTRAINTS

### Child Seats



E142594

# Child Safety

Use a child safety seat (sometimes called an infant carrier, convertible seat, or toddler seat) for infants, toddlers, or children weighing 40 lb (18 kg) or less (generally age four or younger).

## Using Lap and Shoulder Belts (Except Front Center Position of Super Cab and Crew Cab)

### WARNINGS



Do not place a rearward facing child restraint in front of an active airbag. Failure to follow this instruction could result in personal injury or death.



Even with advanced restraints systems, properly restrain children 12 and under in a rear seating position. Failure to follow this could seriously increase the risk of injury or death.



Depending on where you secure a child restraint, and depending on the child restraint design, you may block access to certain seatbelt buckle assemblies and LATCH lower anchors, rendering those features potentially unusable. To avoid risk of injury, make sure occupants only use seating positions where they are able to be properly restrained.

When installing a child safety seat with combination lap and shoulder belts:

- Use the correct seatbelt buckle for that seating position.
- Insert the belt tongue into the proper buckle until you hear a snap and feel it latch. Make sure the tongue is securely fastened in the buckle.
- Keep the buckle release button pointing up and away from the safety seat, with the tongue between the child restraint and the release button, to prevent accidental unbuckling.

- Place the vehicle seat upon which the child restraint will be installed in the upright position.
- Put the seatbelt in the automatic locking mode. This vehicle does not require the use of a locking clip.

Perform the following steps when installing the child restraint with combination lap and shoulder belts:

**Note:** *Although the child restraint illustrated is a forward facing child restraint, the steps are the same for installing a rear facing child restraint.*



E142528

1. Position the child safety seat in a seat with a combination lap and shoulder belt.



E142529

2. Pull down on the shoulder belt and then grasp the shoulder belt and lap belt together.



# Child Safety



E142530

3. While holding the shoulder and lap belt portions together, route the tongue through the child restraint according to the child restraint manufacturer's instructions. Be sure the belt webbing is not twisted.



E142875

5. To put the retractor in the automatic locking mode, grasp the shoulder portion of the belt and pull downward until you pull all of the belt out.

**Note:** *The automatic locking mode is available on the front passenger and rear seats. This vehicle does not require the use of a locking clip.*

6. Allow the belt to retract to remove slack. The belt clicks as it retracts to indicate it is in the automatic locking mode.
7. Try to pull the belt out of the retractor to make sure the retractor is in the automatic locking mode (you should not be able to pull more belt out). If the retractor is not locked, unbuckle the belt and repeat Steps 5 and 6.

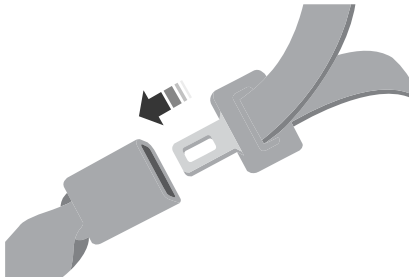

E142531

4. Insert the belt tongue into the proper buckle (the buckle closest to the direction the tongue is coming from) for that seating position until you hear a snap and feel the latch engage. Make sure the tongue is latched securely by pulling on it.



E142533

# Child Safety

- Remove remaining slack from the belt. Force the seat down with extra weight, for example, by pressing down or kneeling on the child restraint while pulling up on the shoulder belt in order to force slack from the belt. This is necessary to remove the remaining slack that exists once you add the extra weight of the child to the child restraint. It also helps to achieve the proper snugness of the child restraint to your vehicle. Sometimes, a slight lean toward the buckle helps to remove remaining slack from the belt.
- Attach the tether strap (if the child restraint is equipped).

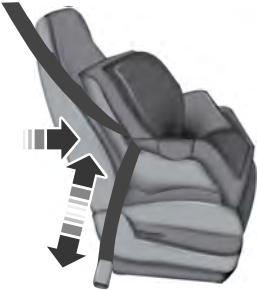

E142534



- Before placing the child in the seat, forcibly move the seat forward and back to make sure the seat is securely held in place.

To check this, grab the seat at the belt path and attempt to move it side to side and forward and back. There should be no more than 1 in (2.5 cm) of movement for proper installation.

We recommend checking with a NHTSA Certified Child Passenger Safety Technician to make certain the child restraint is properly installed. In Canada, check with Transport Canada for referral to a Child Car Seat Clinic.

## Using Lap and Shoulder Belts (Front Center Position of Super Cab and Crew Cab)

### WARNINGS

-  Do not place a rearward facing child restraint in front of an active airbag. Failure to follow this instruction could result in personal injury or death.
-  Always use both the lap and shoulder portion of the seatbelt in the center seating position.

The belt webbing below the tongue is the lap portion of the combination lap and shoulder belt. The belt webbing above the tongue is the shoulder belt portion of the combination lap and shoulder belt.



E142528

- Position the child safety seat in the front center seat.



E162708

# Child Safety

2. Slide the tongue up the webbing.



E142530

3. While holding both shoulder and lap portions next to the tongue, route the tongue and webbing through the child restraint according to the child restraint manufacturer's instructions. Be sure that the belt webbing is not twisted.

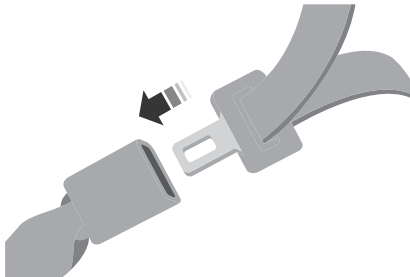

E142531

4. Insert the belt tongue into the proper buckle (the buckle closest to the direction the tongue is coming from) for that seating position until you hear a snap and feel the latch engage. Make sure the tongue is latched securely by pulling on it.



E142533

5. While pushing down with your knee on the child restraint, pull up on the shoulder belt portion to tighten the lap belt portion of the combination lap and shoulder belt.
6. Allow the seatbelt to retract and remove any slack in the belt to securely tighten the child safety seat in the vehicle.
7. Attach the tether strap (if the child restraint is equipped).

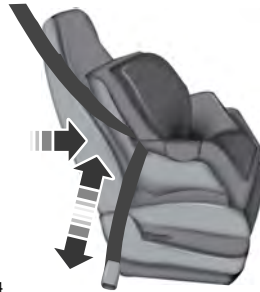

E142534

8. Before placing the child in the seat, forcibly move the seat forward and back to make sure the seat is securely held in place. To check this, grab the seat at the belt path and attempt to move it side to side and forward and back. There should be no more than 1 in (2.5 cm) of movement for proper installation.

# Child Safety

9. Check from time to time to be sure that there is no slack in the lap and shoulder belt. The shoulder belt must be snug to keep the lap belt tight during a crash.

We recommend checking with a NHTSA Certified Child Passenger Safety Technician to make certain the child restraint is properly installed. In Canada, check with Transport Canada for referral to a Child Car Seat Clinic.

## Using Inflatable Seatbelts (Rear Seat Outboard Positions) (If Equipped)



E142528

1. Position the child safety seat in a seat with a combination lap and shoulder belt.



E146522

2. After positioning the child safety seat in the proper seating position, grasp the shoulder belt and lap belt together behind the belt tongue.



E142530

3. While holding the shoulder and lap belt portions together, route the tongue through the child restraint according to the child restraint manufacturer's instructions. Be sure the belt webbing is not twisted.

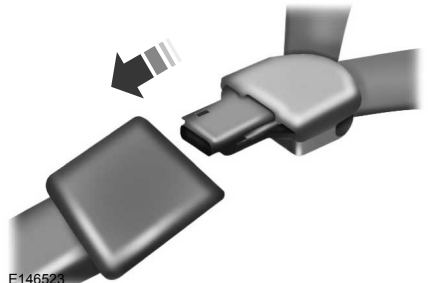

E146523

4. Insert the belt tongue into the proper buckle (the buckle closest to the direction the tongue is coming from) for that seating position until you hear a snap and feel the latch engage. Make sure the tongue is latched securely by pulling on it.

## Child Safety

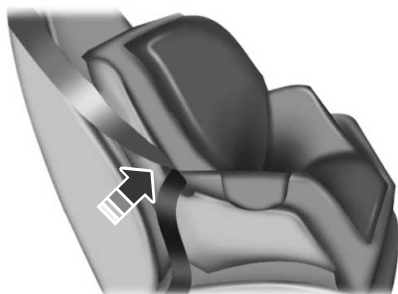

E146524

5. To put the retractor in the automatic locking mode, grasp the lap portion of the inflatable seatbelt and pull upward until you pull all of the belt out.

**Note:** The automatic locking mode is available on the front passenger and rear seats.

**Note:** Unlike the standard seatbelt, the inflatable seatbelt's unique lap portion locks the child restraint for installation. The ability for the shoulder portion of the belt to move freely is normal, even after the lap belt has been put into the automatic locking mode.

**Note:** The lock-off device on some child restraints may not accommodate the shoulder portion of the inflatable seatbelt. Follow all instructions provided by the manufacturer of the child restraint regarding the necessary and proper use of the lock-off device. In some instances, these devices have been provided only for use in vehicles with seatbelt systems that would otherwise require a locking clip.

6. Allow the belt to retract to remove slack. The belt clicks as it retracts to indicate it is in the automatic locking mode.

7. Try to pull the belt out of the retractor to make sure the retractor is in the automatic locking mode (you should not be able to pull more belt out). If the retractor is not locked, unbuckle the belt and repeat Steps 5 and 6.

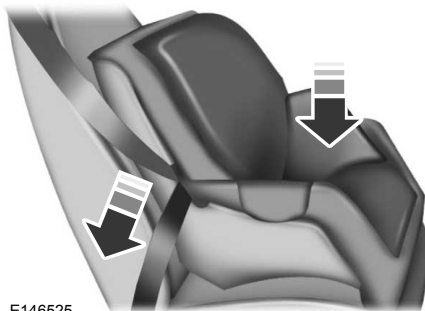

E146525

8. Remove remaining slack from the belt. Force the seat down with extra weight, for example, by pressing down or kneeling on the child restraint while pulling down on the lap belt in order to force slack from the belt. This is necessary to remove the remaining slack that exists once you add the extra weight of the child to the child restraint. It also helps to achieve the proper snugness of the child restraint to your vehicle. Sometimes, a slight lean toward the buckle will additionally help to remove remaining slack from the belt.
9. Attach the tether strap (if the child restraint is equipped).

# Child Safety

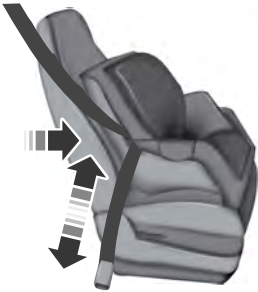

E142534

10. Before placing the child in the seat, forcibly move the seat forward and back to make sure the seat is securely held in place. To check this, grab the seat at the belt path and attempt to move it side to side and forward and back. There should be no more than 1 in (2.5 cm) of movement for proper installation.

We recommend checking with a NHTSA Certified Child Passenger Safety Technician to make certain the child restraint is properly installed. In Canada, check with Transport Canada for referral to a Child Car Seat Clinic.

## Using Lower Anchors and Tethers for Children (LATCH)

### WARNINGS



Do not attach two child safety restraints to the same anchor. In a crash, one anchor may not be strong enough to hold two child safety restraint attachments and may break, causing serious injury or death.

### WARNINGS



Depending on where you secure a child restraint, and depending on the child restraint design, you may block access to certain seatbelt buckle assemblies and LATCH lower anchors, rendering those features potentially unusable. To avoid risk of injury, make sure occupants only use seating positions where they are able to be properly restrained.

The LATCH system is composed of three vehicle anchor points: two lower anchors where the vehicle seat backrest and seat cushion meet (called the seat bight) and one top tether anchor behind that seating position.

LATCH compatible child safety seats have two rigid or webbing mounted attachments that connect to the two lower anchors at the LATCH equipped seating positions in your vehicle. This type of attachment method eliminates the need to use seatbelts to attach the child restraint. However, you can still use the seatbelt to attach the child restraint if the lower anchors are not used. For forward-facing child restraints, you must also attach the top tether strap to the proper top tether anchor if a top tether strap has been provided with your child restraint.

Your vehicle has LATCH lower anchors for child restraint installation at the following seating positions (LATCH is not available on Regular Cab):

# Child Safety

## Crew Cab and Super Cab

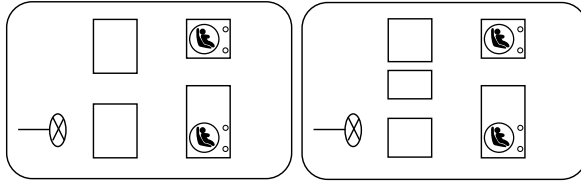

E166694



E166695

The lower LATCH anchors are at the rear section of the rear seat between the cushion and seat backrest. Follow the child restraint manufacturer's instructions to properly install a child restraint with LATCH attachments.

Follow the instructions later in this chapter on attaching child safety seats with tether straps.

Attach LATCH lower attachments of the child restraint only to the anchors shown.

## Use of Inboard Lower Anchors from the Outboard Seating Positions (Center Seating Use)

### WARNING



The standardized spacing for LATCH lower anchors is 11 in (280 mm) center to center. Do not use LATCH lower anchors for the center seating position unless the child restraint manufacturer's instructions permit and specify using anchors spaced at least as far apart as those in this vehicle.

The lower anchors at the center of the second row rear seat are spaced 26 in (652 mm) apart. The standardized spacing for LATCH lower anchors is 11 in (280 mm) center to center. You cannot install a child restraint with rigid LATCH attachments at the center seating position. LATCH compatible child restraints (with attachments on belt webbing) can only be used at this seating position provided that the child restraint manufacturer's instructions permit use with the anchor spacing stated. Do not attach a child restraint to any lower anchor if an adjacent child restraint is attached to that anchor.

# Child Safety

Each time you use the safety seat, check that the seat is properly attached to the lower anchors and tether anchor, if applicable. Tug the child restraint from side to side and forward and back where it is secured to the vehicle. The seat should move less than 1 in (2.5 cm) when you do this for a proper installation.

If the safety seat is not anchored properly, the risk of a child being injured in a crash greatly increases.

## Combining Seatbelt and LATCH Lower Anchors for Attaching Child Safety Seats

When used in combination, either the seatbelt or the LATCH lower anchors may be attached first, provided a proper installation is achieved. Attach the tether strap afterward, if included with the child restraint.

## Using Tether Straps

Many forward-facing child safety seats include a tether strap which extends from the back of the child safety seat and hooks to an anchoring point called the top tether anchor. Tether straps are available as an accessory for many older safety seats. Contact the manufacturer of your child restraint for information about ordering a tether strap, or to obtain a longer tether strap if the tether strap on your safety seat does not reach the appropriate top tether anchor in the vehicle.

The passenger seats of your vehicle may have built-in tether strap anchors behind the seats as described below.

The tether anchors in your vehicle may be loops of webbing above the seat backrest or an anchor bracket behind the seat on the rear edge of the seat cushion.

The rear seat in the Crew Cab and Super Cab has three straps along the top of the seat backrest that function as both routing loops for the tether straps and anchor loops.

The tether strap anchors in your vehicle are in the following positions (shown from top view):

### Regular Cab

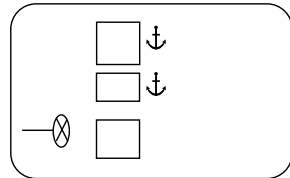

E166696

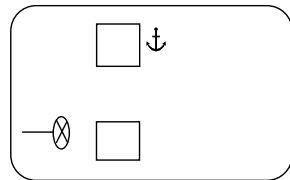

E251549



# Child Safety

## Crew Cab and Super Cab

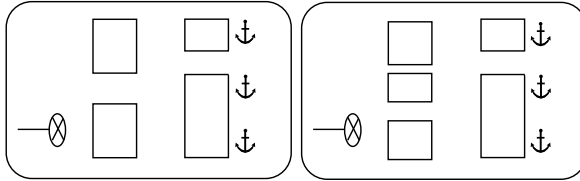

E251550

Attach the tether strap only to the appropriate tether anchor as shown. The tether strap may not work properly if attached somewhere other than the correct tether anchor.

If you install a child restraint with rigid LATCH attachments, do not tighten the tether strap enough to lift the child restraint off the vehicle seat cushion when the child is seated in it. Keep the tether strap just snug without lifting the front of the child restraint. Keeping the child restraint just touching the vehicle seat gives the best protection in a severe crash.

Once the child safety seat has been installed using either the seatbelt, the lower anchors of the LATCH system, or both, you can attach the top tether strap.

### Front Seat Tether Strap Attachment (Regular Cab)

**Note:** For vehicles with adjustable head restraints, route the tether strap under the head restraint and between the head restraint posts, otherwise route the tether strap over the top of the seatback.

1. Route the child safety seat tether strap over the back of the seat and under the head restraint.

2. Locate the correct anchor for the selected seating position. You may need to pull the seat backrest forward to access the tether anchors. Make sure the seat is locked in the upright position before installing the child restraint.
3. Clip the tether strap to the anchor.
4. Tighten the child safety seat tether strap according to the manufacturer's instructions.

### Regular Cab passenger and center seats (located on back panel)



E175295

If the tether strap is clipped incorrectly, the child safety seat may not be retained properly in the event of a crash.

If the safety seat is not anchored properly, the risk of a child being injured in a crash greatly increases.

# Child Safety

If your child restraint system has a tether strap, and the child restraint manufacturer recommends its use, we also recommend its use.

## Rear Seat Tether Strap Attachment (Crew Cab and Super Cab)



E167009

There are three loops of webbing just above the back of the rear seat (along the bottom edge of the rear window). Use these loops as both routing loops and anchor loops for up to three child safety seat tether straps.

For example, you can use the center loop as a routing loop for a child safety seat in the center rear seat and as an anchoring loop for child restraints installed in the outboard rear seats.

Many tether straps cannot be tightened if the tether strap is hooked to the loop directly behind the child restraint.

To provide a tight tether strap:

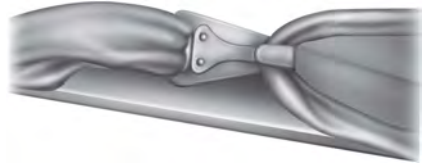

E162715

1. Route the vehicle tether loop between the head restraint posts, then route the child seat tether strap through the loop, forward of the head restraint.
2. Hook the strap to the vehicle tether anchor loop in the adjacent seating position. If using the driver side, pass the strap behind the shoulder belt for the center seat. Always put the tether strap through the routing loop. The head restraint support post holds the child restraint tightly, but the head restraint post is not strong enough to hold the child restraint during a crash.
3. Tighten the tether strap according to the child restraint manufacturer's instructions.

If the safety seat is not anchored properly, the risk of a child being injured in a crash greatly increases.

If your child restraint system has a tether strap, and the child restraint manufacturer recommends its use, we also recommend its use.

# Child Safety

## BOOSTER SEATS

### WARNING



Do not put the shoulder section of the seatbelt or allow the child to put the shoulder section of the seatbelt under their arm or behind their back. Failure to follow this instruction could reduce the effectiveness of the seatbelt and increase the risk of injury or death in a crash.

**Note:** *Some booster seat seatbelt guides may not accommodate the shoulder portion of the inflatable seatbelt.*

Use a belt-positioning booster seat for children who have outgrown or no longer properly fit in a child safety seat (generally children who are less than 57 in (1.45 m) tall, are greater than age four (4) and less than age twelve (12), and between 40 lb (18 kg) and 80 lb (36 kg) and upward to 100 lb (45 kg) if recommended by your child restraint manufacturer). Many state and provincial laws require that children use approved booster seats until they reach age eight, a height of 57 in (1.45 m) tall, or 80 lb (36 kg).

Booster seats should be used until you can answer YES to ALL of these questions when seated without a booster seat:

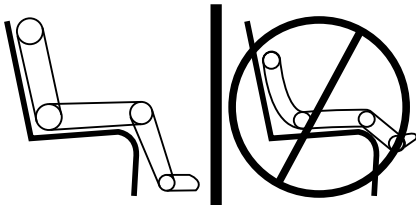

E142595

- Can the child sit all the way back against their vehicle seat backrest with knees bent comfortably at the edge of the seat cushion?
- Can the child sit without slouching?
- Does the lap belt rest low across the hips?
- Is the shoulder belt centered on the shoulder and chest?
- Can the child stay seated like this for the whole trip?

Always use booster seats in conjunction with your vehicle lap and shoulder belt.

## Types of Booster Seats



E68924

- Backless booster seats

If your backless booster seat has a removable shield, remove the shield. If a vehicle seating position has a low seat backrest or no head restraint, a backless booster seat may place your child's head (as measured at the tops of the ears) above the top of the seat. In this case, move the backless booster to another seating position with a higher seat backrest or head restraint and lap and shoulder belts, or consider using a high back booster seat.

# Child Safety



E70710

- High back booster seats

If, with a backless booster seat, you cannot find a seating position that adequately supports your child's head, a high back booster seat would be a better choice.

Children and booster seats vary in size and shape. Choose a booster that keeps the lap belt low and snug across the hips, never up across the stomach, and lets you adjust the shoulder belt to cross the chest and rest snugly near the center of the shoulder. The following drawings compare the ideal fit (center) to a shoulder belt uncomfortably close to the neck and a shoulder belt that could slip off the shoulder. The drawings also show how the lap belt should be low and snug across the child's hips.



E142596



E142597



# Child Safety

If the booster seat slides on the vehicle seat upon which it is being used, placing a rubberized mesh sold as shelf or carpet liner under the booster seat may improve this condition. Do not introduce any item thicker than this under the booster seat. Check with the booster seat manufacturer's instructions.

## CHILD RESTRAINT POSITIONING

### WARNINGS



Airbags can kill or injure a child in a child seat. Never place a rear-facing child seat in front of an active airbag. If you must use a forward-facing child seat in the front seat, move the vehicle seat upon which the child seat is installed all the way back. When possible, all children age 12 and under should be properly restrained in a rear seating position. If all children cannot be seated and restrained properly in a rear seating position, properly restrain the largest child in the front seat.



Always carefully follow the instructions and warnings provided by the manufacturer of any child restraint to determine if the restraint device is appropriate for your child's size, height, weight, or age. Follow the child restraint manufacturer's instructions and warnings provided for installation and use in

### WARNINGS

conjunction with the instructions and warnings provided by your vehicle manufacturer. A safety seat that is improperly installed or utilized, is inappropriate for your child's height, age, or weight or does not properly fit the child may increase the risk of serious injury or death.



Never let a passenger hold a child on his or her lap while your vehicle is moving. The passenger cannot protect the child from injury in a crash, which may result in serious injury or death.



Never use pillows, books, or towels to boost a child. They can slide around and increase the likelihood of injury or death in a crash.



Always restrain an unoccupied child seat or booster seat. These objects may become projectiles in a crash or sudden stop, which may increase the risk of serious injury.



Never place, or allow a child to place, the shoulder belt under a child's arm or behind the back because it reduces the protection for the upper part of the body and may increase the risk of injury or death in a crash.



To avoid risk of injury, do not leave children or pets unattended in your vehicle.

# Child Safety

## Recommendations for attaching child safety restraints for children

Restraint Type	Combined weight of child and child seat	Use any attachment method as indicated below by X				
		LATCH (lower anchors and top tether anchor)	LATCH (lower anchors only)	Safety belt and top tether anchor	Safety belt and LATCH (lower anchors and top tether anchor)	Safety belt only
Rear facing child seat	Up to 65 lb (29.5 kg)		X			X
Rear facing child seat	Over 65 lb (29.5 kg)					X
Forward facing child seat	Up to 65 lb (29.5 kg)	X		X	X	
Forward facing child seat	Over 65 lb (29.5 kg)			X	X	

**Note:** The child seat must rest tightly against the vehicle seat upon which it is installed. It may be necessary to lift or remove the head restraint. See **Seats** (page 154).

## CHILD SAFETY LOCKS

When these locks are set, the rear doors cannot be opened from the inside.



E112197

# Child Safety

---

The childproof locks are located on the rear edge of each rear door and must be set separately for each door.

## **Left-Hand Side**

Turn counterclockwise to lock and clockwise to unlock.

## **Right-Hand Side**

Turn clockwise to lock and counterclockwise to unlock.

# Seatbelts

## PRINCIPLE OF OPERATION

### WARNINGS



Always drive and ride with the seatback upright and the lap belt snug and low across the hips.



To reduce the risk of injury, make sure children sit where they can be properly restrained.



Never let a passenger hold a child on his or her lap while your vehicle is moving. The passenger cannot protect the child from injury in a crash which may result in serious injury or death.



All occupants of the vehicle, including the driver, should always properly wear their seatbelts, even when an airbag supplemental restraint system is provided. Failure to properly wear your seatbelt could seriously increase the risk of injury or death.



It is extremely dangerous to ride in a cargo area, inside or outside of a vehicle. In a crash, people riding in these areas are more likely to be seriously injured or killed. Do not allow people to ride in any area of your vehicle that is not equipped with seats and seatbelts. Be sure everyone in your vehicle is in a seat and using a seatbelt properly.



In a rollover crash, an unbelted person is significantly more likely to die than a person wearing a seatbelt.



Each seating position in your vehicle has a specific seatbelt assembly which is made up of one buckle and one tongue that are designed to be used as a pair. 1) Use the shoulder belt on the outside shoulder only. Never wear the shoulder belt under the arm. 2) Never swing the seatbelt around your neck over the inside shoulder. 3) Never use a single belt for more than one person.

### WARNINGS



When possible, all children 12 years old and under should be properly restrained in a rear seating position. Failure to follow this could seriously increase the risk of injury or death.



Seatbelts and seats can become hot in a vehicle that has been closed up in sunny weather; they could burn a small child. Check seat covers and buckles before you place a child anywhere near them.



Front and rear seat occupants, including pregnant women, should wear seatbelts for optimum protection in an accident.

All seating positions in this vehicle have lap and shoulder belts. All occupants of the vehicle should always properly wear their seatbelts, even when an airbag supplemental restraint system is provided.

The seatbelt system consists of:

- Lap and shoulder seatbelts.
- Shoulder seatbelt with automatic locking mode, (except driver seatbelt).
- Height adjuster at the front outboard seating positions.
- Seatbelt pretensioner at the front outboard seating positions.



- Seatbelt warning light and chime.



- Crash sensors and monitoring system with readiness indicator.



# Seatbelts

The seatbelt pretensioners at the front seating positions are designed to tighten the seatbelts when activated. In frontal and near-frontal crashes, the seatbelt pretensioners may be activated alone or, if the crash is of sufficient severity, together with the front airbags. In side crashes and rollovers, the seatbelt pretensioners activate when the Safety Canopy is activated.

## FASTENING THE SEATBELTS

Standard belts shown, inflatable belts similar

The front outboard and rear safety restraints in the vehicle are combination lap and shoulder belts.



E142587

1. Insert the belt tongue into the proper buckle (the buckle closest to the direction the tongue is coming from) until you hear a snap and feel it latch. Make sure you securely fasten the tongue in the buckle.

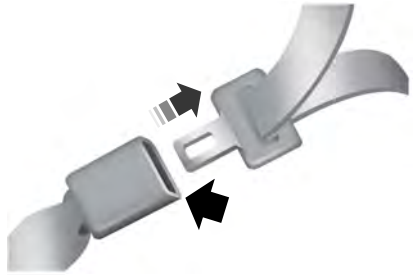

E142588

2. To unfasten, press the release button and remove the tongue from the buckle.

## Using the Seatbelt with Cinch Tongue (Front Center Seat on Super Cab and Crew Cab)

The cinch tongue slides up and down the belt webbing when you stow the belt or while putting seatbelts on. When you buckle the lap and shoulder seatbelt, the cinch tongue allows you to shorten the lap portion, but pinches the webbing to keep the lap portion from getting longer. The cinch tongue is designed to slip during a crash, so always wear the shoulder belt properly and do not allow any slack in either the lap or shoulder portions.

Before you can reach and latch a lap and shoulder belt having a cinch tongue into the buckle, you may have to lengthen the lap belt portion of it.

# Seatbelts



E162708

1. To lengthen the lap belt, pull some webbing out of the shoulder belt retractor.
2. While holding the webbing below the tongue, grasp the tip (metal portion) of the tongue so that it is parallel to the webbing and slide the tongue upward.
3. Provide enough lap belt length so that the tongue can reach the buckle.

## Fastening the Cinch Tongue

### WARNING



Always drive and ride with your seatback upright and the lap belt snug and low across the hips.

1. Pull the lap and shoulder belt from the retractor so that the shoulder belt portion of the seatbelt crosses your shoulder and chest.
2. Be sure the belt is not twisted. If the belt is twisted, remove the twist.
3. Insert the belt tongue into the proper buckle for your seating position until you hear a snap and feel it latch.
4. Make sure you securely fasten the tongue to the buckle by pulling on the tongue.

While you are fastened in the seatbelt, the lap and shoulder belt with a cinch tongue adjusts to your movement. However, if you brake hard, turn hard, or if your vehicle receives an impact of 5 mph (8 km/h) or more, the seatbelt will become locked and help reduce your forward movement.

## Using Seatbelts During Pregnancy

### WARNING



Always ride and drive with your seatback upright and properly fasten your seatbelt. Fit the lap portion of the seatbelt snugly and low across the hips. Position the shoulder portion of the seatbelt across your chest. Pregnant women must follow this practice. See the following figure.

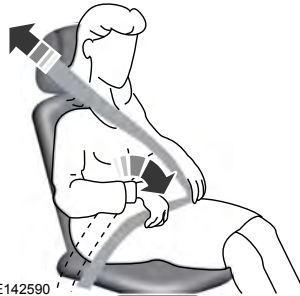

E142590

Pregnant women should always wear their seatbelt. Position the lap belt portion of a combination lap and shoulder belt low across the hips below the belly and worn as tight as comfort allows. Position the shoulder belt to cross the middle of the shoulder and the center of the chest.

# Seatbelts

## Seatbelt Locking Modes

### WARNING



If your vehicle is involved in a crash, have the seatbelts and associated components inspected as soon as possible. Failure to follow this instruction could result in personal injury or death.

All safety restraints in the vehicle are combination lap and shoulder belts. The driver seatbelt has the first type of locking mode, and the front outboard passenger and rear seat seatbelts have both types of locking modes described as follows:

### Vehicle Sensitive Mode

This is the normal retractor mode, which allows free shoulder belt length adjustment to your movements and locking in response to vehicle movement. For example, if the driver brakes suddenly, turns a corner sharply, or the vehicle receives an impact of about 5 mph (8 km/h) or more, the combination seatbelts lock to help reduce forward movement of the driver and passengers.

In addition, the retractor is designed to lock if you pull the webbing out too quickly. If the seatbelt retractor locks, slowly lower the height adjuster to allow the seatbelt to retract. If the retractor does not unlock, pull the seatbelt out slowly then feed a small length of webbing back toward the stowed position. For rear seatbelts, recline the rear seat backrest or push the seat backrest cushion away from the seatbelt. Feed a small length of webbing back toward the stowed position.

### Automatic Locking Mode

In this mode, the shoulder belt automatically pre-locks. The belt still retracts to remove any slack in the shoulder belt. The automatic locking mode is not available on the driver seatbelt.

### When to Use the Automatic Locking Mode

Use this mode any time you install a child safety seat in a front outboard passenger seating position in a Regular Cab, SuperCab, SuperCrew or any rear seating position of a SuperCab or SuperCrew. The optional front seat's center seatbelt has a cinch mechanism. Properly restrain children 12 years old and under in a rear seat whenever possible. See **Child Safety** (page 19).

### How to Use the Automatic Locking Mode

Non-inflatable seatbelts



E142591

1. Buckle the combination lap and shoulder belt.
2. Grasp the shoulder portion and pull downward until you pull the entire belt out.
3. Allow the belt to retract. As the belt retracts, you will hear a clicking sound. This indicates the seatbelt is now in the automatic locking mode.

# Seatbelts

## Rear outboard inflatable seatbelts (second row only— if equipped)



E146363

1. Buckle the combination lap and shoulder belt.
2. Grasp the lap portion of the belt and pull upward until you pull the entire belt out.
3. Allow the belt to retract. As the belt retracts, you will hear a clicking sound. This indicates the seatbelt is now in the automatic locking mode.

### How to Disengage the Automatic Locking Mode

Unbuckle the combination lap and shoulder belt and allow it to retract completely to disengage the automatic locking mode and activate the vehicle sensitive (emergency) locking mode.

### Rear Inflatable Seatbelt (If Equipped)

#### WARNING



Do not attempt to service, repair, or modify the supplementary restraint system or associated components. Failure to follow this instruction could result in personal injury or death.

The rear inflatable seatbelts are in the shoulder portion of the seatbelts of the second-row outboard seating positions.

**Note:** *The rear inflatable seatbelts are compatible with most infant and child safety car seats and belt positioning booster seats when properly installed. This is because they are designed to fill with a cooled gas at a lower pressure and at a slower rate than traditional airbags. After inflation, the shoulder portion of the seatbelt remains cool to the touch.*

The rear inflatable seatbelt consists of the following:

- An inflatable bag in the shoulder seatbelt webbing.
- Lap seatbelt webbing with automatic locking mode.
- The same warning light, electronic control and diagnostic unit as used for the front seatbelts.
- Impact sensors in various parts of the vehicle.

### How does the rear inflatable seatbelt system work?

#### WARNING



If a supplementary restraint system component has deployed, it will not function again. Have the system and associated components inspected as soon as possible. Failure to follow this instruction could result in personal injury or death.

The rear inflatable seatbelts function like standard restraints in everyday usage.

# Seatbelts

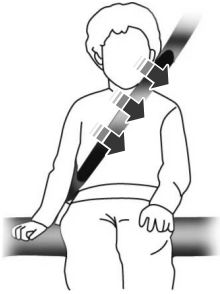

E146364

During a crash of sufficient force, the inflatable belt inflates from inside the webbing.



E146365

The fully inflated belt's increased diameter more effectively holds the occupant in the appropriate seating position, and spreads crash forces over more area of the body than regular seatbelts. This helps reduce pressure on the chest and helps control head and neck motion for passengers.

The rear inflatable seatbelts are designed to inflate in frontal or near-frontal crashes, rollovers and some side impact crashes. The fact that the rear inflatable seatbelt did not inflate in a crash does not mean that something is wrong with the system. Rather, it means the forces were not of the type sufficient to cause activation.

## SEATBELT HEIGHT ADJUSTMENT

### WARNING

 Position the safety belt height adjuster so that the belt rests across the middle of your shoulder. Failure to adjust the safety belt properly could reduce the effectiveness of the safety belt and increase the risk of injury in a crash.

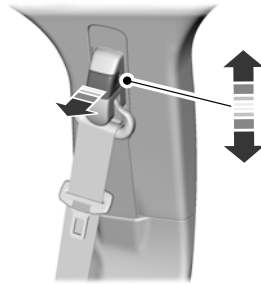

E145664

Adjust the height of the shoulder belt so the belt rests across the middle of your shoulder.

To adjust the shoulder belt height:

1. Pull the button and slide the height adjuster up or down.
2. Release the button and pull down on the height adjuster to make sure it is locked in place.

## SEATBELT WARNING LAMP AND INDICATOR CHIME



This lamp illuminates and an audible warning will sound if the driver seatbelt has not been fastened when the vehicle's ignition is turned on.

# Seatbelts

## Conditions of operation

If	Then
The driver seatbelt is not buckled before the ignition switch is turned to the on position...	The seatbelt warning light illuminates and the warning chime sounds for a few seconds.
The driver seatbelt is buckled while the indicator light is illuminated and the warning chime is sounding...	The seatbelt warning light and warning chime turn off.
The driver seatbelt is buckled before the ignition switch is turned to the on position...	The seatbelt warning light and indicator chime remain off.

## SEATBELT REMINDER

### Belt-Minder™

This feature supplements the seatbelt warning function. It provides additional reminders by intermittently sounding a chime and illuminating the seatbelt warning light when you are in the driver seat and a seatbelt is unbuckled.

If...	Then...
You buckle your seatbelt before you switch the ignition on or less than 1-2 minutes elapse after you switch the ignition on...	The Belt-Minder feature will not activate.
You do not buckle your seatbelt before your vehicle reaches at least 6 mph (9.7 km/h) and 1-2 minutes elapse after you switch the ignition on...	The Belt-Minder feature activates - the seatbelt warning light illuminates and a warning tone sounds for six seconds every 25 seconds, repeating for about five minutes or until you buckle your seatbelt.
The driver seatbelt is unbuckled for about one minute while the vehicle is traveling at least 6 mph (9.7 km/h) and more than 1-2 minutes elapse after you switch the ignition on...	The Belt-Minder feature activates - the seatbelt warning light illuminates and the warning tone sounds for six seconds every 25 seconds, repeating for about five minutes or until you buckle your seatbelt.

# Seatbelts

## Deactivating and Activating the Belt-Minder Feature (Driver only)

### WARNING



While the system allows you to deactivate it, this system is designed to improve your chances of being safely belted and surviving an accident. We recommend you leave the system activated for yourself and others who may use the vehicle. To reduce the risk of injury, do not deactivate or activate the system while driving the vehicle.

**Note:** *If you are using MyKey, you cannot disable the Belt-Minder. Also, if the Belt-Minder has been previously disabled, it will be re-enabled during the use of MyKey. See **MyKey™** (page 63).*

Read Steps 1 - 4 thoroughly before proceeding with the programming procedure.

Before following the procedure, make sure that:

- The parking brake is set.
  - The transmission is in park (P).
  - The ignition is off.
  - All vehicle doors are closed.
  - The driver seatbelt is unbuckled.
1. Switch the ignition on. Do not start the engine.
  2. Wait until the seatbelt warning light turns off (about one minute). You must complete Step 3 within 30 seconds after the seatbelt warning light turns off.
  3. Buckle then unbuckle the seatbelt three times at a moderate speed, ending with the seatbelt in the unbuckled state. After Step 3, the seatbelt warning light turns on.

4. While the seatbelt warning light is on, buckle then unbuckle the seatbelt. After Step 4, the seatbelt warning light flashes for confirmation.
  - This will switch the feature off if it is currently on.
  - This will switch the feature on if it is currently off.

## CHILD RESTRAINT AND SEATBELT MAINTENANCE

Inspect the vehicle safety belts and child safety seat systems periodically to make sure they work properly and are not damaged. Inspect the vehicle and child seat safety belts to make sure there are no nicks, tears or cuts. Replace if necessary. All vehicle safety belt assemblies, including retractors, buckles, front safety belt buckle assemblies, buckle support assemblies (slide bar-if equipped), shoulder belt height adjusters (if equipped), shoulder belt guide on seat back (if equipped), child safety seat LATCH and tether anchors, and attaching hardware, should be inspected after a crash. Read the child restraint manufacturer's instructions for additional inspection and maintenance information specific to the child restraint.

Ford Motor Company recommends that all safety belt assemblies in use in vehicles involved in a crash be replaced. However, if the crash was minor and an authorized dealer finds that the belts do not show damage and continue to operate properly, they do not need to be replaced. Safety belt assemblies not in use during a crash should also be inspected and replaced if either damage or improper operation is noted.

Properly care for safety belts. See **Vehicle Care** (page 370).

# Seatbelts

---

## SEATBELT EXTENSION

### WARNINGS



Persons who fit into the vehicle's seatbelt should not use an extension. Unnecessary use could result in serious personal injury in the event of a crash.



Only use extensions provided free of charge by Ford Motor Company dealers. The dealer will provide an extension designed specifically for this vehicle, model year and seating position. The use of an extension intended for another vehicle, model year or seating position may not offer you the full protection of your vehicle's seatbelt restraint system.



Never use seatbelt extensions to install child restraints.



Do not use a seatbelt extension with an inflatable seatbelt.



Do not use extensions to change the fit of the belt across the torso, over the lap or to make the seatbelt buckle easier to reach.

---

If, because of body size or driving position, it is not possible to properly fasten the seatbelt over your lap and shoulder, an extension that is compatible with the seatbelts is available free of charge from Ford Motor Company dealers. Only Ford seatbelt extensions made by the original equipment seatbelts manufacturer should be used with Ford seatbelts. Ask your authorized dealer if your extension is compatible with your Ford vehicle restraint system.





# Supplementary Restraints System

---

## PRINCIPLE OF OPERATION

### WARNINGS

 Airbags do not inflate slowly or gently, and the risk of injury from a deploying airbag is the greatest close to the trim covering the airbag module.

 All occupants of your vehicle, including the driver, should always properly wear their safety belts, even when an airbag supplemental restraint system is provided. Failure to properly wear your safety belt could seriously increase the risk of injury or death.

 Always transport children 12 years old and under in the back seat and always properly use appropriate child restraints. Failure to follow this could seriously increase the risk of injury or death.

 Never place your arm over the airbag module as a deploying airbag can result in serious arm fractures or other injuries.

 Airbags can kill or injure a child in a child seat. Never place a rear-facing child seat in front of an active airbag. If you must use a forward-facing child seat in the front seat, move the seat upon which the child seat is installed all the way back.

 Do not attempt to service, repair, or modify the airbag supplemental restraint systems or its fuses as you could be seriously injured or killed. Contact your authorized dealer as soon as possible.

 Several airbag system components get hot after inflation. To avoid risk of injury, do not touch them after inflation.

 If the airbag has deployed, the airbag will not function again and must be replaced immediately. If the airbag is not replaced, the unrepaired area will increase the risk of injury in a crash.

The airbags are a supplemental restraint system and are designed to work with the safety belts to help protect the driver and right front passenger from certain upper body injuries. Airbags do not inflate slowly; there is a risk of injury from a deploying airbag.

**Note:** *You will hear a loud bang and see a cloud of harmless powdery residue if an airbag deploys. This is normal.*

The airbags inflate and deflate rapidly upon activation. After airbag deployment, it is normal to notice a smoke-like, powdery residue or smell the burnt propellant. This may consist of cornstarch, talcum powder (to lubricate the bag) or sodium compounds (for example, baking soda) that result from the combustion process that inflates the airbag. Small amounts of sodium hydroxide may be present which may irritate the skin and eyes, but none of the residue is toxic.

While the system is designed to help reduce serious injuries, contact with a deploying airbag may also cause abrasions or swelling. Temporary hearing loss is also a possibility as a result of the noise associated with a deploying airbag. Because airbags must inflate rapidly and with considerable force, there is the risk of death or serious injuries such as fractures, facial and eye injuries or internal injuries, particularly to occupants who are not properly restrained or are otherwise out of position at the time of airbag deployment. Thus, it is extremely important that occupants be properly restrained as far away from the airbag module as possible while maintaining vehicle control.

Routine maintenance of the airbags is not required.

# Supplementary Restraints System

## DRIVER AND PASSENGER AIRBAGS

### WARNINGS



Never place your arm over the airbag module as a deploying airbag can result in serious arm fractures or other injuries.



Airbags can kill or injure a child in a child restraint. Never place a rear-facing child restraint in front of an active airbag. If you must use a forward-facing child restraint in the front seat, move the seat upon which the child seat is installed all the way back.

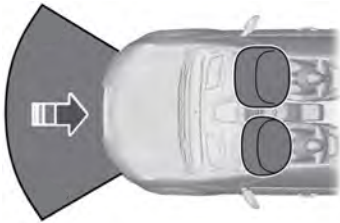

E151127

The driver and front passenger airbags deploy during significant frontal and near frontal crashes.

The driver and passenger front airbag system consists of:

- Driver and passenger airbag modules.



• Crash sensors and monitoring system with readiness indicator. See **Crash Sensors and Airbag Indicator** (page 54).

## Passenger Airbag On and Off Switch (If Equipped)

### WARNINGS



Even with advanced restraints systems, properly restrain children 12 and under in a rear seating position. Failure to follow this could seriously increase the risk of injury or death.



The front passenger airbag is not designed to offer protection to an occupant in the center seating position.



Your vehicle may have an airbag deactivation switch. Before driving, always look at the switch to make sure it is in the appropriate position. Failure to put the switch in the proper position can increase the risk of serious injury or death in a crash.

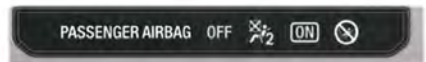

E181984

### High-series vehicles (If equipped)

The front passenger airbag on and off switch has indicators that illuminate, indicating that the front passenger frontal airbag is either on or off. The indicator lamp is near the center of the instrument panel.

**Note:** *The passenger airbag status indicator OFF and ON lamps illuminate for a short period of time when you switch the ignition on to confirm it is functional.*

# Supplementary Restraints System

Switch position	Passenger airbag status indicator	Passenger airbag
Off	OFF: Lit	Disabled
	ON: Unlit	
On	OFF: Unlit	Enabled
	ON: Lit	



E229376

## Low-series vehicles (if equipped)

The front passenger airbag on and off switch has an indicator that illuminates and stays lit to remind you that the front passenger frontal airbag is off. The indicator lamp is near the center of the instrument panel.

**Note:** The indicator lamp illuminates for a short period of time when you switch the ignition on to confirm it is functional.

## Turning the Passenger Airbag Off

### WARNINGS

 If the light does not illuminate when the passenger airbag switch is off and you switch the ignition on, have the passenger airbag switch serviced immediately by a qualified technician.

 To avoid switching on the airbag, always remove the ignition key with the switch in the off position.

### WARNINGS

 If your vehicle has rear seats, always transport children who are 12 and younger in the rear seat. Always use seatbelts and child restraints properly. Do not place a child in a rear facing infant seat in the front seat unless your vehicle is equipped with an airbag on and off switch and the passenger airbag is turned off. This is because the back of the infant seat is too close to the inflating airbag and the risk of a fatal injury to the infant when the airbag inflates is substantial.

The passenger airbag on and off switch is in the glovebox.



E181522

# Supplementary Restraints System

1. Insert the ignition key, turn the switch to OFF and hold in OFF while removing the key.
2. When you switch the ignition on, the passenger airbag off light illuminates briefly, momentarily shuts off and then turns back on. This indicates that the passenger airbag is deactivated.

## Turning the Passenger Airbag Back On

### WARNINGS



The seatbelts for the driver and right front passenger seating positions are specifically designed to operate together with the airbags in certain types of crashes. When you switch off your airbag, you not only lose the protection of the airbag, you also may reduce the effectiveness of your seatbelt system. If the passenger does not meet the requirements stated in the National Highway Traffic Safety Administration or Transport Canada deactivation criteria, switching off the airbag can increase the risk of serious injury or death in a crash.



If your vehicle has rear seats, always transport children who are 12 and younger in the rear seat. Always use seatbelts and child restraints properly. Do not place a child in a rear facing infant seat in the front seat unless your vehicle is equipped with an airbag on and off switch and the passenger airbag is turned off. This is because the back of the infant seat is too close to the inflating airbag and the risk of a fatal injury to the infant when the airbag inflates is substantial.



If the passenger airbag off light is illuminated when the passenger airbag switch is on and the ignition is on, have the passenger airbag switch serviced immediately by a qualified technician.

The passenger airbag remains off until you turn it back on.



E181521

1. Insert the ignition key and turn the switch to ON.
2. The passenger airbag off light will briefly illuminate when you switch the ignition on. This indicates that the passenger airbag is operational.

The passenger side airbag should always be on (the passenger airbag off light should not be illuminated) unless the passenger is a person who meets the requirements stated either in Category 1, 2 or 3 of the National Highway Traffic Safety Administration or Transport Canada deactivation criteria which follows.

The vast majority of drivers and passengers are much safer with an airbag than without. To do their job and reduce the risk of life threatening injuries, airbags must open with great force, and this force can pose a potentially deadly risk in some situations, particularly when a front seat occupant is not properly buckled up. The most effective way to reduce the risk of unnecessary airbag injuries without reducing the overall safety of the vehicle is to make sure all occupants are properly restrained in the vehicle, especially in the

# Supplementary Restraints System

---

front seat. This provides the protection of seatbelts and permits the airbags to provide the additional protection they were designed to provide. If you choose to deactivate your airbag, you are losing the very significant risk reducing benefits of the airbag and you are also reducing the effectiveness of the seatbelts, because seatbelts in modern vehicles are designed to work as a safety system with the airbags.

## National Highway Traffic Safety Administration Deactivation Criteria (Excluding Canada)

### WARNING



This vehicle has special energy management seatbelts for the driver and right front passenger. These particular seatbelts are specifically designed to work with airbags to help reduce the risk of injury in a crash. The energy management seatbelt gives or releases additional seatbelt webbing in some accidents to reduce the concentration of force on an occupant's chest and to reduce the risk of certain bone fractures and injuries to underlying organs. In a crash, if the airbag is off, this energy management seatbelt might permit the passenger wearing the seatbelt to move forward enough to have a serious or fatal injury. The more severe the crash, and the heavier the occupant, the greater the risk. Make sure the airbag is on for any passenger who does not qualify under the National Highway Traffic Safety Administration deactivation criteria.

**1. Infant.** An infant (less than 1 year old) must ride in the front seat because:

- The vehicle has no rear seat;
- The vehicle has a rear seat too small to accommodate a rear-facing infant seat; or
- The infant has a medical condition which, according to the infant's physician, makes it necessary for the infant to ride in the front so that the driver can constantly monitor the child's condition.

**2. Child age 1 to 12.** A child age 1 to 12 must ride in the front seat because:

- The vehicle has no rear seat;
- Although children ages 1 to 12 ride in the rear seat(s) whenever possible, children ages 1 to 12 sometimes must ride in the front because no space is available in the rear seat(s) of the vehicle; or
- The child has a medical condition which, according to the child's physician, makes it necessary for the child to ride in the front seat so that the driver can constantly monitor the child's condition.

**3. Medical condition.** A passenger has a medical condition which, according to his or her physician:

- Causes the passenger airbag to pose a special risk for the passenger;
- Makes the potential harm from the passenger airbag in a crash greater than the potential harm from turning off the airbag and allowing the passenger, even if belted, to hit the dashboard or windshield in a crash.

# Supplementary Restraints System

## Transport Canada Deactivation Criteria (Canada Only)

### WARNING



This vehicle has special energy management seatbelts for the driver and right front passenger. These particular seatbelts are specifically designed to work with airbags to help reduce the risk of injury in a crash. The energy management seatbelt gives or releases additional seatbelt webbing in some accidents to reduce the concentration of force on an occupant's chest and to reduce the risk of certain bone fractures and injuries to underlying organs. In a crash, if the airbag is off, this energy management seatbelt might permit the passenger wearing the seatbelt to move forward enough to have a serious or fatal injury. The more severe the crash, and the heavier the occupant, the greater the risk. Make sure the airbag is on for any passenger who does not qualify under the National Highway Traffic Safety Administration deactivation criteria.

**1. Infant:** An infant (less than 1 year old) must ride in the front seat because:

- My vehicle has no rear seat;
- The rear seat in my vehicle cannot accommodate a rear-facing infant seat;
- The infant has a medical condition which, according to the infant's physician, makes it necessary for the infant to ride in the front seat so that the driver can monitor the infant's condition.

**2. Child age 12 or under:** A child age 12 or under must ride in the front seat because:

- My vehicle has no rear seat;
- Although children age 12 and under ride in the rear seat whenever possible, children age 12 and under have no option but to sometimes ride in the front seat because rear seat space is insufficient;
- The child has a medical condition that, according to the child's physician, makes it necessary for the child to ride in the front seat so that the driver can monitor the child's condition.

**3. Medical condition:** A passenger has a medical condition that, according to his or her physician:

- Poses a special risk for the passenger if the airbag deploys; and
- Makes the potential harm from the passenger airbag deployment greater than the potential harm from turning off the airbag and experiencing a crash without the protection offered by the airbag

## Proper Driver and Front Passenger Seating Adjustment

### WARNING



National Highway Traffic Safety Administration (NHTSA) recommends a minimum distance of at least 10 in (25 cm) between an occupant's chest and the driver airbag module.

To properly position yourself away from the airbag:

- Move your seat to the rear as far as you can while still reaching the pedals comfortably.
- Recline the seat slightly (one or two degrees) from the upright position.

# Supplementary Restraints System

After all occupants have adjusted their seats and put on seatbelts, it is very important that they continue to sit properly. Properly seated occupants sit upright, lean against the seat back, and center themselves on the seat cushion, with their feet comfortably extended on the floor. Sitting improperly can increase the chance of injury in a crash event. For example, if an occupant slouches, lies down, turns sideways, sits forward, leans forward or sideways, or puts one or both feet up, the chance of injury during a crash greatly increases.

## Children and Airbags

### WARNING

 Airbags can kill or injure a child in a child restraint. Never place a rear-facing child restraint in front of an active airbag. If you must use a forward-facing child restraint in the front seat, move the seat upon which the child seat is installed all the way back.







E142846

Children must always be properly restrained. Accident statistics suggest that children are safer when properly restrained in the rear seating positions than in the front seating position. Failure to follow these instructions may increase the risk of injury in a crash.

If two adults and a child occupy a Regular Cab, properly restrain the child in the center front unless doing so would interfere with driving your vehicle. This provides lap and shoulder belt protection for all occupants, and airbag protection for the adults. A child or infant properly restrained in the center front seat should not incur risk of serious injury from the airbags.

## SIDE AIRBAGS

### WARNINGS

-  Do not place objects or mount equipment on or near the airbag cover, on the side of the seatbacks (of the front seats), or in front seat areas that may come into contact with a deploying airbag. Failure to follow these instructions may increase the risk of personal injury in the event of a crash.
-  Do not use accessory seat covers. The use of accessory seat covers may prevent the deployment of the side airbags and increase the risk of injury in an accident.
-  Do not lean your head on the door. The side airbag could injure you as it deploys from the side of the seatback.
-  Do not attempt to service, repair, or modify the airbag, its fuses or the seat cover on a seat containing an airbag as you could be seriously injured or killed. Contact your authorized dealer as soon as possible.
-  If the side airbag has deployed, the airbag will not function again. The side airbag system (including the seat) must be inspected and serviced by an authorized dealer. If the airbag is not replaced, the unrepaired area will increase the risk of injury in a crash.

# Supplementary Restraints System

The side airbags are located on the outboard side of the seatbacks of the front seats. In certain sideways crashes, the airbag on the side affected by the crash will be inflated. The airbag was designed to inflate between the door panel and occupant to further enhance the protection provided occupants in side impact crashes.



E152533

The system consists of the following:

- A label or embossed side panel indicating that side airbags are found on your vehicle.
- Side airbags located inside the seatback of the driver and front passenger seats.









• Crash sensors and monitoring system with readiness indicator. See **Crash Sensors and Airbag Indicator** (page 54).

The design and development of the side airbag system included recommended testing procedures that were developed by a group of automotive safety experts known as the Side Airbag Technical Working Group. These recommended testing procedures help reduce the risk of injuries related to the deployment of side airbags.

## SAFETY CANOPY™

### WARNINGS

-  Do not place objects or mount equipment on or near the headliner at the siderail that may come into contact with a deploying curtain airbag. Failure to follow these instructions may increase the risk of personal injury in the event of a crash.
-  Do not lean your head on the door. The curtain airbag could injure you as it deploys from the headliner.
-  Do not attempt to service, repair, or modify the supplementary restraint system or associated components. Failure to follow this instruction could result in personal injury or death.
-  All occupants of your vehicle, including the driver, should always properly wear their seatbelts, even when an airbag supplemental restraint system is provided. Failure to properly wear your seatbelt could seriously increase the risk of injury or death.
-  To reduce risk of injury, do not obstruct or place objects in the deployment path of the airbag.
-  If a supplementary restraint system component has deployed, it will not function again. Have the system and associated components inspected as soon as possible. Failure to follow this instruction could result in personal injury or death.

The Safety Canopy deploys during significant side crashes or when a certain likelihood of a rollover event is detected by the rollover sensor. The Safety Canopy is mounted to the roof side rail sheet metal, behind the headliner, above each row of seats. In certain sideways crashes or rollover events, the Safety Canopy will be



# Supplementary Restraints System

activated, regardless of which seats are occupied. The Safety Canopy is designed to inflate between the side window area and occupants to further enhance protection provided in side impact crashes and rollover events.

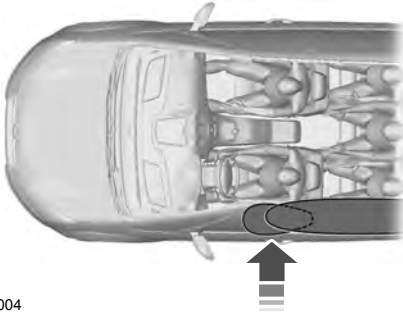

E75004

The system consists of the following:

- Safety Canopy curtain airbags above the trim panels over the front and rear side windows identified by a label or wording on the headliner or roof-pillar trim.
- A flexible headliner which opens above the side doors to allow air curtain deployment



• Crash sensors and monitoring system with a readiness indicator. See **Crash Sensors and Airbag Indicator** (page 54).

Properly restrain children 12 years old and under in the rear seats. The Safety Canopy will not interfere with children restrained using a properly installed child or booster seat because it is designed to inflate downward from the headliner above the doors along the side window opening.

The design and development of the Safety Canopy included recommended testing procedures that were developed by a group of automotive safety experts known as the Side Airbag Technical Working Group. These recommended testing procedures help reduce the risk of injuries related to the deployment of side airbags (including the Safety Canopy).

## CRASH SENSORS AND AIRBAG INDICATOR

### WARNING



Modifying or adding equipment to the front end of the vehicle (including frame, bumper, front end body structure and tow hooks) may affect the performance of the airbag system, increasing the risk of injury. Do not modify the front end of the vehicle.

Your vehicle has a collection of crash and occupant sensors which provide information to the restraints control module which deploys (activates) the front safety belt pretensioners, driver airbag, passenger airbag, seat mounted side airbags, and the Safety Canopy®. Based on the type of crash (frontal impact, side impact or rollover), the restraints control module will deploy the appropriate safety devices.

The restraints control module also monitors the readiness of the above safety devices plus the crash and occupant sensors. The readiness of the safety system is indicated by a warning indicator light in the instrument cluster or by a backup tone if the warning light is not working. See **Instrument Cluster** (page 105). Routine maintenance of the airbag is not required.

A difficulty with the system is indicated by one or more of the following:

# Supplementary Restraints System

---



The readiness light will not illuminate immediately after the ignition is turned on.

- The readiness light will either flash or stay lit.
- A series of five beeps will be heard. The tone pattern will repeat periodically until the problem, the light or both are repaired.

If any of these things happen, even intermittently, have the supplemental restraint system serviced at an authorized dealer immediately. Unless serviced, the system may not function properly in the event of a crash.

The fact that the safety belt pretensioners or front airbags did not activate for both front seat occupants in a crash does not mean that something is wrong with the system. Rather, it means the restraints control module determined the accident conditions (crash severity, belt usage) were not appropriate to activate these safety devices.

- The design of the front airbags is to activate only in frontal and near-frontal crashes (not rollovers, side impacts or rear impacts) unless the crash causes sufficient frontal deceleration.
- The design of the safety belt pretensioners is to activate in frontal, near-frontal and side crashes, and in rollovers.

- The design of the side airbags is to inflate in certain side impact crashes. Side airbags may activate in other types of crashes if the vehicle experiences sufficient sideways motion or deformation.
- The design of the Safety Canopy is to inflate in certain side impact crashes or rollover events. The Safety Canopy may activate in other types of crashes if the vehicle experiences sufficient sideways motion or deformation, or a certain likelihood of rollover.

## AIRBAG DISPOSAL

Contact your authorized dealer as soon as possible. Airbags must be disposed of by qualified personnel.

# Keys and Remote Controls

## GENERAL INFORMATION ON RADIO FREQUENCIES

This device complies with Part 15 of the FCC Rules and with Industry Canada license-exempt RSS standard(s). Operation is subject to the following two conditions: (1) This device may not cause harmful interference, and (2) This device must accept any interference received, including interference that may cause undesired operation.

**Note:** *Changes or modifications not expressly approved by the party responsible for compliance could void the user's authority to operate the equipment. The term "IC:" before the radio certification number only signifies that Industry Canada technical specifications were met.*

The typical operating range for your transmitter is approximately 33 ft (10 m). Vehicles with the remote start feature will have a greater range. One of the following could cause a decrease in operating range:

- Weather conditions.
- Nearby radio towers.
- Structures around the vehicle.
- Other vehicles parked next to your vehicle.

Other short-distance radio transmitters, such as amateur radios, medical equipment, wireless headphones, remote controls and alarm systems may operate on the same frequency as your remote control. If other transmitters are operating on those frequencies, you may not be able to use your remote control. Using your remote control near some types of electronic equipment, such as USB devices, computers or cell phones can interfere with remote operation. Operating your remote control near metal or metallic-finished purses, bags or clothing can interfere with remote operation. You can lock and unlock the doors with the key.

**Note:** *Make sure to lock your vehicle before leaving it unattended.*

**Note:** *If you are in range, the remote control still operates if you press any button unintentionally.*

## Intelligent Access (If Equipped)

The system uses a radio frequency signal to communicate with your vehicle and authorize your vehicle to unlock when one of the following conditions are met:

- You touch the inside of the front exterior door handle within 3 ft (1 m) proximity of an intelligent access key.
- You press the tailgate release button.
- You press a button on the remote control.

If excessive radio frequency interference is present in the area or if the remote control battery is low, you may need to mechanically unlock your door. You can use the mechanical key blade in your intelligent access key to open the driver door in this situation. See **Remote Control** (page 56).

## REMOTE CONTROL

### Integrated Keyhead Transmitter (If Equipped)

Use the key blade to start your vehicle and unlock or lock the driver door from outside your vehicle. The integrated keyhead transmitter functions as a programmed ignition key that operates all the locks and starts your vehicle, as well as a remote control.

# Keys and Remote Controls

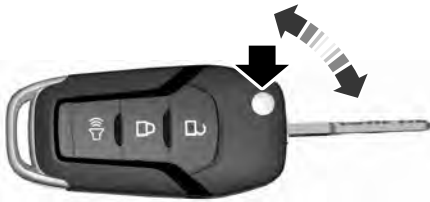

E191532

Press the button to release the key blade. Press and hold the button to fold the key blade back when not in use.



E151795

**Note:** Your vehicle keys came with a security label that provides important key cut information. Keep the label in a safe place for future reference.

## Intelligent Access Key (If Equipped)

**Note:** You may not be able to shift out of park (P) unless the intelligent access key is inside your vehicle.



E226461

The intelligent access keys operate the power locks and the remote start system. The key must be in your vehicle to use the push button start.

## Removable Key Blade

The intelligent access key also contains a removable key blade that you can use to unlock your vehicle.

# Keys and Remote Controls



E226462

Press the release button and pull the key blade out.



E151795

**Note:** Your vehicle keys came with a security label that provides important key cut information. Keep the label in a safe place for future reference.

## Replacing the Battery

**Note:** Refer to local regulations when disposing of transmitter batteries.

**Note:** Do not wipe off any grease on the battery terminals or on the back surface of the circuit board.

**Note:** Replacing the battery does not erase the programmed key from your vehicle. The transmitter should operate normally.

A message appears in the information display when the remote control battery is low. See **General Information** (page 113).

## Integrated Keyhead Transmitter

The remote control uses one coin-type three-volt lithium battery CR2032 or equivalent.

Press the button to release the key blade before beginning the procedure.



E191533

1. Insert a suitable tool, for example a screwdriver, in the position shown and gently push the clip.
2. Press the clip down to release the battery cover.

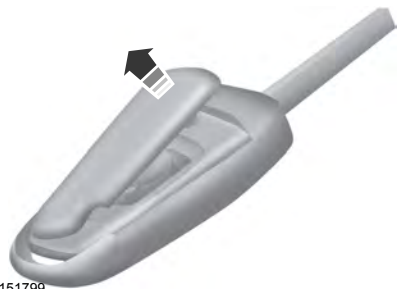

E151799

3. Carefully remove the cover.

# Keys and Remote Controls



E151800

**Note:** Do not touch the battery contacts or the printed circuit board with the screwdriver.

4. Insert a suitable tool, for example a screwdriver, in the position shown to release the battery.



E151801

5. Remove the battery.
6. Insert a new battery with the + facing upward.
7. Reinstall the battery housing cover onto the transmitter.

## Intelligent Access Key

The remote control uses one coin-type three-volt lithium battery CR2032 or equivalent.



E226462

1. Press the release button and pull the key blade out.

## Keys and Remote Controls



E218401

2. Twist a thin coin under the tab hidden behind the key blade head to remove the battery cover.



E218402

3. Insert a suitable tool, for example a screwdriver, in the position shown and carefully remove the battery.
4. Insert a new battery with the **+** facing upward.
5. Reinstall the battery housing cover onto the transmitter and install the key blade.

### Memory Feature (If Equipped)

You can use the remote control to recall memory positions.

Press the unlock button on a linked remote control to recall memory positions. If you enable the easy entry and exit feature, the seat moves to the easy entry position. The seat moves to the driver memory position when you switch the ignition on.

### Linking a Preset Position to your Remote Control

See **Memory Function** (page 159).

# Keys and Remote Controls

## Car Finder



Press the button twice within three seconds. A tone sounds and the direction indicators flash. We recommend you use this method to locate your vehicle, rather than using the panic alarm.

## Sounding the Panic Alarm



Press the button to sound the panic alarm. Press the button again or switch the ignition on to turn it off.

**Note:** *The panic alarm only operates when the ignition is off.*

## Remote Start (If Equipped)

### WARNING



To avoid exhaust fumes, do not use remote start if your vehicle is parked indoors or in areas that are not well ventilated.

**Note:** *Do not use remote start if your fuel level is low.*



The remote start button is on the transmitter.

This feature allows you to start your vehicle from the outside. The transmitter has an extended operating range.

You can configure vehicles with automatic climate control to turn on the automatic climate control when you remote start your vehicle. See **Automatic Climate Control** (page 147). A manual climate control system runs at the setting you set it to when you switched your vehicle off.

Many states and provinces restrict the use of remote start. Check your local and state or provincial laws for specific requirements regarding remote start systems.

The remote start system does not work if any of the following occur:

- The ignition is on.
- The anti-theft alarm triggers.
- You switch off the feature.
- The hood is open.
- The transmission is not in park (P).
- The battery voltage is below the minimum operating voltage.
- The service engine soon light is on.

## Remote Control Feedback

An LED on the remote control provides status feedback of remote start or stop commands.

LED	Status
Solid green	Remote start or extension successful
Solid red	Remote stop successful; vehicle off
Blinking red	Remote start or stop failed
Blinking green	Waiting for status update

## Remote Starting Your Vehicle

**Note:** *You must press each button within three seconds of each other.*

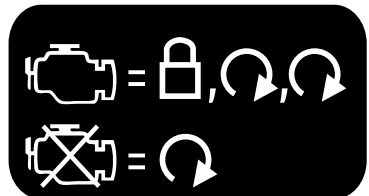

E138626



# Keys and Remote Controls

---

The label on your transmitter details the starting procedure.

To remote start your vehicle:

1. Press the lock button.
2. Press the remote start button twice. The exterior lamps flash twice.

The horn sounds if the system fails to start, unless quiet start is on. Quiet start runs the blower fan at a slower speed to reduce noise. You can switch it on or off in the information display. See **General Information** (page 113).

**Note:** *If you do not follow this sequence, your vehicle does not start remotely, the direction indicators do not flash twice and the horn does not sound.*

**Note:** *If you remote start your vehicle with an integrated keyhead transmitter, you must switch on the ignition before driving your vehicle. If you remote start your vehicle with an intelligent access transmitter, you must press the push button ignition switch on the instrument panel once while applying the brake pedal before driving your vehicle.*

The power windows do not work during remote start and the radio does not turn on automatically.

The parking lamps remain on and your vehicle runs for 5, 10 or 15 minutes depending on the setting.

## **Extending the Engine Running Time**

To extend the engine running time duration of your vehicle during remote start, repeat steps 1 and 2 while the engine is running. If the duration is set to 10 minutes, the duration extends by another 10 minutes. For example, if your vehicle had been running from the first remote start for 5 minutes, your vehicle continues to run now for a total of 20 minutes. You can extend the remote start up to a maximum of 35 minutes.

Wait at least five seconds before remote starting after the engine stops running.

## **Turning Your Vehicle Off After Remote Starting**



Press the button once. The parking lamps turn off.

You may have to be closer to the vehicle than when starting due to ground reflection and the added noise of the running vehicle.

You can turn the remote start system on or off using the information display. See **General Information** (page 113).

## **REPLACING A LOST KEY OR REMOTE CONTROL**

Replacement keys or remote controls can be purchased from an authorized dealer. Authorized dealers can program remote controls for your vehicle. See **Passive Anti-Theft System** (page 76).

## PRINCIPLE OF OPERATION

MyKey allows you to program keys with restricted driving modes to promote good driving habits. You can program the restrictions to all keys but one. Any keys that you did not program are administrator keys or admin keys.

You can use admin keys to:

- Create a MyKey with certain vehicle restrictions.
- Program certain MyKey settings.
- Clear all MyKey restrictions.

After you program a MyKey, you can view the following information through the information display:

- The total number of admin keys and MyKeys for your vehicle.
- The total distance a MyKey driver traveled with your vehicle.

**Note:** Every MyKey receives the same restrictions and settings. You cannot program them individually.

**Note:** For vehicles equipped with a push-button start switch: When both a MyKey and an admin key are present when you start your vehicle, the system recognizes the admin key only.

## Standard Settings

Not every vehicle includes the features listed below. If your vehicle has this equipment, then you cannot change the following settings when using a MyKey:

- Seatbelt reminder or Belt-Minder™. MyKey mutes the audio system until drivers, and in some instances, passengers, fasten their seatbelts.
- Earlier low-fuel warning. The low-fuel warning activates earlier for MyKey drivers, giving them more time to refuel.

- Certain driver alerts, stability systems or parking aids turn on automatically when you use the MyKey system. For example, Blind Spot Information System (BLIS), cross traffic alert, lane departure warning or forward collision warning.
- Restricted touchscreen operation in some markets. For example, MyKey may prevent manual navigation destination input while the vehicle is in any gear other than park (P) or when the vehicle reaches a certain rate of speed.
- Satellite radio adult content restrictions, if this feature is available in your market.

**Note:** MyKey drivers may be able to switch the lane departure warning feature off, but this feature turns back on automatically with every new key cycle.

**Note:** MyKey drivers can turn on the forward collision warning when it is turned off by an admin key.

**Note:** If your vehicle includes an AM/FM radio or a very basic audio system, then the radio may not mute.

## Optional Settings

You can configure certain vehicle feature settings when you first create a MyKey. You can also change the settings afterward with an admin key.

**Note:** Not every feature applies to every vehicle in every market. When they are available for your vehicle, then they appear in your information display, providing choices to switch them on or off, or to select a more specific setting.

- Various vehicle speed limits so the MyKey driver cannot exceed certain speeds. The information display shows warnings followed by an audible tone when the MyKey driver reaches the set speed. You cannot override the set speed by fully depressing the accelerator pedal.

## WARNING



Do not set MyKey maximum speed limit to a limit that will prevent the driver from maintaining a safe speed considering posted speed limits and prevailing road conditions. The driver is always responsible to drive in accordance with local laws and prevailing conditions. Failure to do so could result in accident or injury.

- Various vehicle speed reminders so MyKey drivers know when their vehicle speed approaches the limits. Warnings appear in your information display and a tone sounds when the MyKey drivers exceed the set vehicle speed.
- The audio system's maximum volume limits to 45% so MyKey drivers can concentrate on the road. A message appears in the information display when MyKey drivers attempt to exceed the limited volume. MyKey also disables the automatic volume control.
- Always on setting. This setting forces certain features to remain on and active for MyKey drivers. For example, E911 or emergency assistance and the do not disturb features stay on even if a MyKey driver uses the feature's control to switch it off.

**Note:** *If your vehicle includes an AM/FM radio or a very basic audio system, then the radio may not mute.*

## CREATING A MYKEY

Use the information display to create a MyKey.

1. Switch the ignition on using the key or the transmitter you want to program. If your vehicle has a push-button start, place the transmitter into the backup slot. See **Passive Anti-Theft System** (page 76).
2. Access the main menu in the information display and then scroll through the menus to begin programming your MyKey. See **Information Displays** (page 113).
3. Follow the instructions in the display.
4. A confirmation message appears in the display after you finish programming your MyKey. The programmed restrictions apply when you key off, open and close driver door and restart your vehicle with the programmed key or transmitter.

**Note:** *Make sure you label the programmed MyKey so you can distinguish it from the admin keys.*

You can also program the optional MyKey settings.

## Programming or Changing Configurable Settings

Use the information display to program or change your optional MyKey settings.

1. Switch the ignition on using the key or the transmitter you want to program.
2. Access the main menu in the information display and then scroll through the menus to change the settings of your MyKey. See **Information Displays** (page 113).
3. Follow the instructions in the display.

4. A confirmation message appears in the display after you finish programming your MyKey. The programmed restrictions apply when you key off, open and close the driver door and restart your vehicle with the programmed key or transmitter.

**Note:** *You can clear or change your MyKey settings at any time during the same key cycle as you created the MyKey. If you switch the engine off, you must use an admin key to change or clear your optional MyKey settings.*

## CLEARING ALL MYKEYS

When you clear your MyKeys, you remove all restrictions and return all MyKeys to their original admin key status at once. To clear all MyKeys of all MyKey settings, use the information display.

1. Switch the ignition on using an admin key.
2. Access the main menu in the information display and then scroll through the menus to begin clearing your MyKey programming. See **Information Displays** (page 113).
3. Follow the instructions in the display.
4. A confirmation message appears in the display after you finish clearing your MyKeys.

**Note:** *When you clear your MyKeys, you remove all restrictions and return all MyKeys to their original admin key status. You cannot remove the MyKey restrictions individually.*

## MYKEY TROUBLESHOOTING

## CHECKING MYKEY SYSTEM STATUS

You can find information about your programmed MyKeys by using the information display. See **Information Displays** (page 113).

### MyKey Distance

Tracks the distance when drivers use a MyKey. The only way to delete the accumulated distance is by using an admin key to clear all MyKeys. If the distance does not accumulate as expected, then the intended user is not using the MyKey, or an admin key user recently cleared and then recreated a MyKey.

### Number of MyKeys

Indicates the number of MyKeys programmed to your vehicle. Use this feature to detect how many MyKeys you have for your vehicle and determine when all MyKeys have been deleted.

### Number of Admin Keys

Indicates how many admin keys are programmed to your vehicle. Use this feature to determine how many admin keys you have for your vehicle, and detect if an additional MyKey has been programmed.

## USING MYKEY WITH REMOTE START SYSTEMS

MyKey is not compatible with non Ford-approved, aftermarket remote start systems. If you choose to install a remote start system, see an authorized dealer for a Ford-approved remote start system.

# MyKey™

Condition	Potential causes
I cannot create a MyKey.	<ul style="list-style-type: none"> <li>· The key or transmitter used to start the vehicle does not have admin privileges.</li> <li>· Vehicles with keyless start: Make sure you place the transmitter into the backup slot. See <b>Passive Anti-Theft System</b> (page 76).</li> <li>· The key or transmitter used to start the vehicle is the only admin key. There always has to be at least one admin key.</li> <li>· SecuriLock passive anti-theft system is disabled or in unlimited mode.</li> </ul>
I cannot program the configurable settings.	<ul style="list-style-type: none"> <li>· The key or transmitter used to start the vehicle does not have admin privileges.</li> <li>· There are no MyKeys programmed to the vehicle. See <b>Creating a MyKey</b> (page 64).</li> </ul>
For vehicles with keyless start: No MyKey restrictions are available when starting the vehicle.	<ul style="list-style-type: none"> <li>· An admin transmitter is present when you started your vehicle.</li> <li>· There are no MyKeys programmed to the vehicle. See <b>Creating a MyKey</b> (page 64).</li> </ul>
I cannot clear the MyKeys.	<ul style="list-style-type: none"> <li>· The key or transmitter used to start the vehicle does not have admin privileges.</li> <li>· No MyKeys are created. See <b>Creating a MyKey</b> (page 64).</li> </ul>
I lost the only admin key.	<ul style="list-style-type: none"> <li>· Purchase a new key or transmitter from your authorized dealer.</li> </ul>
I lost a key.	<ul style="list-style-type: none"> <li>· Program a spare key or transmitter. You may need to see your authorized dealer. See <b>Passive Anti-Theft System</b> (page 76).</li> </ul>
MyKey distances do not accumulate.	<ul style="list-style-type: none"> <li>· The MyKey user is not using the MyKey.</li> <li>· An admin key holder cleared the MyKeys and created new MyKeys.</li> <li>· The key system has been reset.</li> </ul>

# Doors and Locks

## LOCKING AND UNLOCKING

You can use the power door lock control or the remote control to lock and unlock your doors and tailgate. See **Tailgate** (page 72).

### Power Door Locks (If Equipped)

The power door lock control is on the driver and front passenger door panels.

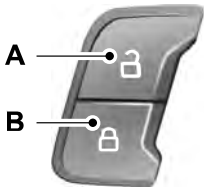

E138628

A Unlock.

B Lock.

### Remote Control (If Equipped)

You can use the remote control at any time your vehicle is not running.

### Unlocking the Vehicle (Two-Stage Unlock)



Press the button to unlock the driver door. Press the button again within three seconds to unlock all doors. The direction indicators flash. The direction indicators flash twice to confirm the change. The unlocking mode applies to the remote control, keyless entry keypad and intelligent access.

Press and hold both the lock and unlock buttons on the remote control for four seconds to disable or enable two-stage unlocking. Disabling two-stage unlocking allows your entire vehicle to unlock with one press of the button.

Intelligent access at the driver door unlocks your entire vehicle when you disable two-stage unlocking.

### Locking the Vehicle



Press the button to lock all doors. The direction indicators flash.

Press the button again within three seconds to confirm that all the doors are closed. The doors lock again, the horn sounds and the direction indicators flash if all the doors are closed.

### Mislock

If any door is open, or if the hood is open on vehicles with an anti-theft alarm or remote start, the horn sounds twice and the direction indicators do not flash.

### Activating Intelligent Access (If Equipped)

#### General Information

You can unlock and lock the vehicle without taking the keys out of your pocket or purse when your intelligent access key is within 3 ft (1 m) of your vehicle. Intelligent access uses a sensor on the back of the door handle for unlocking and a separate sensor on the face of each door handle for locking.

The system does not function if:

- Your vehicle battery has no charge.
- The key battery has no charge.
- The key frequencies are jammed.

# Doors and Locks

**Note:** The system may not function if the key is close to metal objects or electronic devices, for example keys or a cell phone.

**Note:** If the system does not function, use the key blade to lock and unlock your vehicle. See **Remote Control** (page 56).

## Unlocking Using Intelligent Access



E248555

With your intelligent access key within 3 ft (1 m) of your vehicle, touch the unlock sensor on the back of the door handle for a brief period and then pull on the door handle to unlock, being careful to not touch the lock sensor at the same time or pulling the door handle too quickly. The intelligent access system requires a brief delay to authenticate your intelligent access key fob.

## Locking Using Intelligent Access



E248556

With your intelligent access key within 3 ft (1 m) of your vehicle, touch the outer door handle lock sensor for approximately one second to lock, being careful to not touch the unlock sensor on the back of the door handle at the same time. After locking, you can immediately pull on the door handle to confirm locking occurred without inadvertently unlocking.

**Note:** Do not use the outside door handle as a roof cargo strap.

## At the Electronic Tailgate (If Equipped)



E187693

Press the exterior tailgate release button inside of the tailgate handle. The tailgate unlocks and opens. See **Tailgate Lock** (page 72).

## Smart Unlock (If Equipped)

This feature helps to prevent you from locking your intelligent access key inside your vehicle's passenger compartment or rear cargo area.

If you leave your key in the ignition, when you open the driver door and lock your vehicle with the power door lock control, the doors lock then unlock.

You can still lock your vehicle with the key in the ignition by:

- Using the manual lock on the inside of the door.
- Locking the driver door with a key.
- Using the keyless entry keypad.
- Using the lock button on the remote control.

## Smart Unlocks for Intelligent Access Keys (If Equipped)

This feature helps to prevent you from locking your intelligent access key inside your vehicle's passenger compartment or rear cargo area.

# Doors and Locks

---

When you lock your vehicle using the power door lock control (with the door open, vehicle in park and ignition off), your vehicle searches for an intelligent access key in the passenger compartment after you close the door. If your vehicle finds a key, all of the doors immediately unlock.

In order to override the smart unlock feature and intentionally lock the intelligent access key inside your vehicle, you can lock your vehicle after all doors are closed by using the keyless entry keypad, pressing the lock button on another intelligent access key or touching the locking area on the handle with another intelligent access key in your hand.

When you open one of the front doors and lock your vehicle using the power door lock control, all doors lock then unlock if the ignition is on.

## **Autolock (If Equipped)**

Autolock locks all the doors when:

- All doors are closed.
- The ignition is on.
- You shift into any gear putting your vehicle in motion.
- Your vehicle reaches a speed greater than 12 mph (20 km/h).

Autolock repeats when:

- You open then close any door while the ignition is on and your vehicle speed is 9 mph (15 km/h) or lower.
- Your vehicle reaches a speed greater than 12 mph (20 km/h).

## **Autounlock**

Autounlock unlocks all the doors when:

- The ignition is on, all the doors are closed, and your vehicle has been moving at a speed greater than 12 mph (20 km/h).
- Your vehicle comes to a stop and you switch the ignition off or to the accessory position.
- You open the driver door within 10 minutes of switching the ignition off or to accessory.

**Note:** *The doors do not autounlock if you electronically lock your vehicle after you switch the ignition off and before you open the driver door.*

## **Enabling or Disabling Autounlock**

You can enable or disable the autounlock feature in the information display or an authorized dealer can do it for you. See **General Information** (page 113).

## **Illuminated Entry**

The interior lamps and select exterior lamps illuminate when you unlock the doors with the remote entry system.

The illuminated entry system turns off the lights if:

- The ignition is on.
- You press the remote control lock button.
- After 25 seconds of illumination.

The dome lamp does not turn on if the control is set to the off position.

The lights do not turn off if:

- You switch them on with the dimmer control.
- Any door is open.



# Doors and Locks

## Battery Saver

The battery saver turns off the interior lamps 30 minutes after you switch off the ignition if a door is open and the dome lamp switch is on. It turns off the interior lamps after 10 minutes if the dome lamp switch is off.

## Accessory Mode Battery Saver for Intelligent Access Keys (If Equipped)

If you leave the ignition on after leaving your vehicle, it turns off 15 minutes after you close all of the doors.

## KEYLESS ENTRY (If Equipped)

### SECURICODE™ KEYLESS ENTRY KEYPAD

The keypad is near the driver window and illuminates when you touch it.

**Note:** *If you enter your entry code too fast on the keypad, the unlock function may not work. Re-enter your entry code more slowly.*



E190936

You can use the keypad to:

- Lock or unlock the doors and liftgate.
- Program and erase user codes.
- Arm and disarm the anti-theft alarm.

You can operate the keypad with the factory-set five-digit entry code. The code is located on the owner's wallet card in the glove box and is available from an authorized dealer. You can also create up to five of your own five-digit personal entry codes.

## Programming a Personal Entry Code

To create your own personal entry code:

1. Enter the factory-set code.
2. Press **1•2** on the keypad within five seconds.
3. Enter your personal five-digit code. You must enter each number within five seconds of each other.
4. Press **1•2** on the keypad to save personal code one.

The doors will lock then unlock to confirm that programming was successful.

To program additional personal entry codes, repeat Steps 1-3, then for Step 4:

- Press **3•4** to save personal code two.
- Press **5•6** to save personal code three.
- Press **7•8** to save personal code four.
- Press **9•0** to save personal code five.

### Tips:

- Do not set a code that uses five of the same number.
- Do not use five numbers in sequential order.
- The factory-set code will work even if you have set your own personal code.

## Erasing a Personal Code

1. Enter the factory-set five-digit code.
2. Press and release **1•2** on the keypad within five seconds.
3. Press and hold **1•2** for two seconds. This must be done within five seconds of completing Step 2.

# Doors and Locks

---

All personal codes erase and only the factory-set five-digit code will work.

## Anti-Scan Feature

The keypad will go into an anti-scan mode if you enter the wrong code seven times (35 consecutive button presses). This mode disables the keypad for one minute and the keypad lamp will flash.

The anti-scan feature will turn off after:

- One minute of keypad inactivity.
- Pressing the unlock button on the remote control.
- Switching the ignition on.
- Unlocking the vehicle using intelligent access.

## Unlocking and Locking the Doors

### To Unlock the Driver Door

Enter the factory-set five-digit code or your personal code. You must press each number within five seconds of each other. The interior lamps illuminate.

**Note:** *All doors unlock if you disable the two-stage unlocking feature. See **General Information** (page 113).*

### To Unlock All Doors

Enter the factory-set code or your personal code, then press **3•4** control within five seconds.

### To Lock All Doors

Press and hold **7•8** and **9•0** at the same time with the driver door closed. You do not need to enter the keypad code first.

# Tailgate (If Equipped)

## TAILGATE LOCK (If Equipped)

The tailgate lock can help prevent theft of the tailgate.



E224958

Insert the ignition key into the tailgate lock. Turn it to the left to lock the tailgate. Turn it to the right to unlock the tailgate.

## REMOVING THE TAILGATE

### WARNING



Always properly secure cargo to prevent shifting cargo or cargo falling from the vehicle. Failure to do so could result in compromised vehicle stability and serious personal injury to vehicle occupants or others.

You can remove the tailgate for more loading room.

1. Obtain the tailgate removal kit from the glove box.

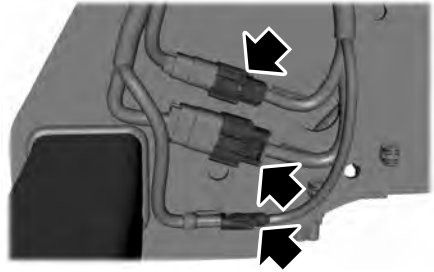

E248384

2. Locate and disconnect the frame connections. They are on the left-hand side of the vehicle.

**Note:** Your vehicle may have up to three frame connections.

3. Install the caps from the tailgate removal kit on the in-line connectors that remain on the vehicle.

**Note:** If you do not install the caps on the connectors, some features may not operate as intended.

4. Partially lower the tailgate. Carefully feed the tailgate harness up through the bumper and place it out of the way.
5. Lower the tailgate.

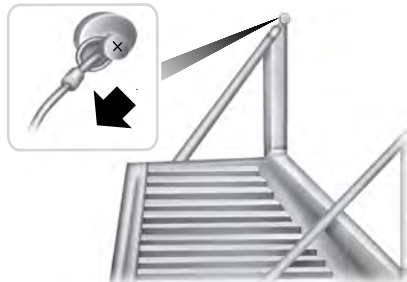

E163092

6. Use a screwdriver to gently pry the spring clip on each connector past the head of the support screw. Disconnect the cable.

## Tailgate (If Equipped)

7. Disconnect the other cable.
8. Lift the tailgate to a 45 degree angle from horizontal.
9. Lift the right side off its hinge.
10. Lift the tailgate to an 80 degree angle from horizontal.
11. Remove the tailgate from the left side hinge by sliding it to the right.

Reverse the steps to reinstall the tailgate.

### TAILGATE STEP (If Equipped)

Use the step to make entering the truck bed easier.

To reduce the risk of falling:

- Only operate the step when your vehicle is on a level surface.
- Only operate the step in areas with sufficient lighting.
- Always open the step panel to widen the step.
- Always use the grab handle when climbing on the step.
- Do not use the step with bare feet.
- Make sure the step is clean before use.
- Keep the step load, you plus the load, below 350 lb (159 kg).

### Opening the Step

**Note:** Make sure to close and fully latch the step before moving your vehicle. Do not drive with the step or grab handle open.

1. Lower the tailgate.
2. Push the button in the center of the step molding. The step pops out slightly.

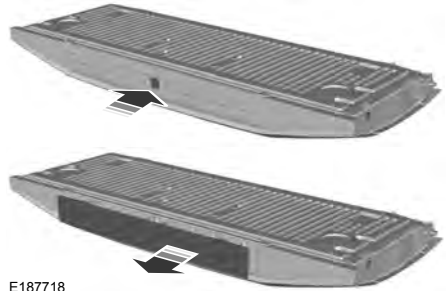

E187718

3. Pull the step out fully. Lower the step to its lowest position.



E189557

4. Pull the yellow handle stop backward out of the tailgate until it fully extends.
5. Rotate the handle up from horizontal to vertical until you hear a click. You have locked the handle in place.

**Note:** Do not tow with the step or grab handle.

Replace the slip resistance tape or grab handle molding if it appears as worn or damaged.

# Tailgate (If Equipped)

## Closing the Step

1. Press the yellow button on the telescoping handle to lower the handle, then press the yellow lever at the bottom of the handle to unlock the handle. Rotate the handle down from vertical to horizontal and push it into the tailgate.
2. Rotate the step up until it is horizontal, then push it back into the tailgate until the step is secure.

1. Pull the locking pin toward the center of your vehicle.



E163096

## BED EXTENDER (If Equipped)

**Note:** Do not use the bed extender when driving off road.

**Note:** Make sure to engage the locking pins and knobs fully before driving your vehicle.

**Note:** Make sure to secure all cargo.

**Note:** Do not exceed 150 pounds (68 kilograms) on the tailgate when your vehicle is moving.

**Note:** Do not keep the bed extender in the tailgate mode when you are not using it for restraining cargo. Always keep the bed extender in the grocery mode or the stowed position with the tailgate closed.

2. Open the latches to release the panels.



E163097

## Tailgate mode



E163095

3. Rotate the panels toward the tailgate. Repeat Steps 1-3 on the other side of your vehicle.



E163098

## Tailgate (If Equipped)

---

4. Connect the two panels. Rotate both knobs one-quarter turn clockwise to secure the panels.

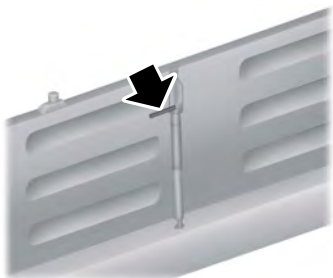

E163099

5. Make sure to insert the latch rod into the tailgate hole. Make sure to engage both sides of the locking pins into their holes in the pick-up box.

Reverse the steps to store the bed extender.

### Grocery mode



E163100

Follow Steps 1-4 of the tailgate mode instructions by rotating the panels away from the tailgate. Close the tailgate.

# Security

---

## PASSIVE ANTI-THEFT SYSTEM

**Note:** *The system is not compatible with non-Ford aftermarket remote start systems. Use of these systems may result in engine starting problems and a loss of security protection.*

**Note:** *Metallic objects, electronic devices or a second coded key on the same key chain may result in vehicle starting problems, especially if they are too close to the key when starting your vehicle. Prevent these objects from touching the coded key when starting your vehicle. Switch the ignition off, move all objects on the key chain away from the coded key and restart your vehicle if a problem occurs.*

**Note:** *Do not leave a duplicate coded key in your vehicle. Always take your keys and lock all doors when leaving your vehicle.*

### SecuriLock®

The system helps prevent the engine from starting unless you use a coded key programmed to your vehicle. Using the wrong key may prevent your vehicle from starting. A message may appear in the information display.

If you are unable to start your vehicle with a coded key, it is not operating correctly. A message may appear in the information display.

### Automatic Arming

The system arms when you switch the ignition off.

### Automatic Disarming

The system disarms when you switch the ignition on with a coded key.

### Replacement Keys

**Note:** *Your vehicle comes with two keys.*

The integrated keyhead transmitter functions as a programmed ignition key that operates all the locks and starts your vehicle, as well as a remote control.

The intelligent access key functions as a programmed key that operates the driver door lock and turns on the intelligent access with push button start system, as well as a remote control.

If your coded keys are lost or stolen and you do not have an extra coded key, you need to erase the key codes from your vehicle and program new coded keys. Contact an authorized dealer.

Store an extra programmed key away from your vehicle in a safe place. You can purchase replacement keys or remote controls from an authorized dealer.

### Programming a Spare Integrated Keyhead Transmitter

**Note:** *You can program a maximum of four keys to your vehicle. All six can be integrated keyhead transmitters.*

You can program your own integrated keyhead transmitter or standard SecuriLock coded keys to your vehicle. This procedure programs both the vehicle immobilizer keycode and the remote control to your vehicle.

Only use integrated keyhead transmitters or standard SecuriLock keys.

You must have two previously programmed coded keys and the new unprogrammed key readily accessible. Contact an authorized dealer to have the spare key programmed if two previously programmed keys are not available.

Read and understand the entire procedure before you begin.

1. Insert the first previously programmed coded key into the ignition.

# Security

---

2. Switch the ignition from off to on. Keep the ignition on for at least 3 seconds, but no more than 10 seconds.
3. Switch the ignition off and remove the first coded key from the ignition.
4. After at least 3 seconds but within 10 seconds of switching the ignition off, insert the second previously coded key into the ignition.
5. Switch the ignition from off to on. Keep the ignition on for at least 3 seconds, but no more than 10 seconds.
6. Switch the ignition off and remove the second previously programmed coded key from the ignition.
7. After at least 3 seconds but within 10 seconds of switching the ignition off and removing the previously programmed coded key, insert the new unprogrammed key into the ignition.
8. Switch the ignition from off to on. Keep the ignition on for at least six seconds.
9. Remove the newly programmed coded key from the ignition.

If you have successfully programmed the new integrated keyhead transmitter, it will start your vehicle and operate the remote entry system.

If programming was unsuccessful, wait 10 seconds and repeat steps 1 through 9. If you are still unsuccessful, take your vehicle to your authorized dealer.

## Programming a Spare Intelligent Access Key

**Note:** *Do not place the device on the wireless accessory charging area when programming intelligent access keys.*

**Note:** *You can program a maximum of six keys to your vehicle. All six must be intelligent access keys.*

This procedure programs both the vehicle immobilizer keycode and the remote control to your vehicle.

You must have two previously programmed intelligent access keys inside your vehicle and the new unprogrammed intelligent access key readily accessible. Contact an authorized dealer to have the spare key programmed if two previously programmed keys are not available.

Make sure that the ignition is switched off before beginning this procedure. Make sure that you close all the doors before beginning and that they remain closed throughout the procedure. Carry out all steps within 30 seconds of starting the sequence. Stop and wait for at least one minute before starting again if you carry out any steps out of sequence.

Read and understand the entire procedure before you begin.



# Security

## Type One

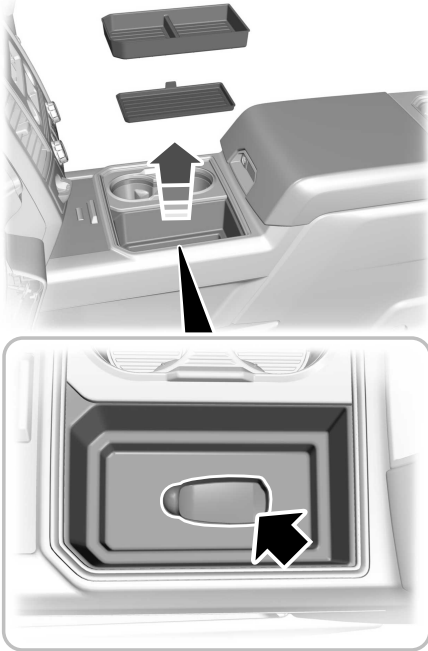

E226701

## Type Two



E269950

1. Remove the key blade from the transmitter.

2. Remove the tray and the cover from the center console. With the buttons facing upward, place the first intelligent access key in the backup slot.
3. Press the push button ignition switch.
4. Wait five seconds and then press the push button ignition switch again.
5. Remove the intelligent access key.
6. Within 10 seconds, place a second programmed intelligent access key in the backup slot and press the push button ignition switch.
7. Wait five seconds and then press the push button ignition switch again.
8. Remove the intelligent access key.
9. Wait five seconds, then place the unprogrammed intelligent access key in the backup slot and press the push button ignition switch.

Programming is now complete. Check that the remote control functions operate and your vehicle starts with the new intelligent access key.

If programming was unsuccessful, wait 10 seconds and repeat steps 1 through 7. If you are still unsuccessful, take your vehicle to your authorized dealer.

## ANTI-THEFT ALARM

The active anti-theft system is designed to warn you in the event of unauthorized vehicle entry and is also designed to help prevent unwanted towing of your vehicle. You can choose what is monitored by arming the system in different ways. See **Information Displays** (page 113).

The direction indicators flash and the horn sounds if the system triggers while the alarm is armed.

Take all remote controls to an authorized dealer if there is any potential alarm problem with your vehicle.

# Security

---

## Using the System

You can select two levels of alarm security. You can change the level of security through the information display. See **General Information** (page 113).

### Reduced Guard (If Equipped)

Reduced guard monitors the following:

- Doors.
- Hood.

### Full Guard (If Equipped)

Full guard monitors the following:

- Doors.
- Hood.
- Movement inside your vehicle.
- Change in vehicle inclination, for example, unwanted towing.

**Note:** *Do not choose full monitor mode when the vehicle is in transport or if movement within the vehicle is likely to occur.*

**Note:** *For correct operation of the interior motion detection system, make sure you close all the windows prior to arming the system. This helps prevent accidental alarm activation due to external influences. Additionally, the interior motion sensing system does not arm if any door is ajar.*

## Arming the Alarm

The alarm is ready to arm when there is not a key in the ignition. Lock your vehicle using the remote control or keyless entry keypad. You can also lock your vehicle using the lock sensor on the exterior door handle if your vehicle is equipped with intelligent access. See **Locking and Unlocking** (page 67).

The direction indicators flash once after you lock your vehicle. This indicates the alarm is in the pre-armed mode. It fully arms after 20 seconds.

## Disarming the Alarm

Disarm the alarm by any of the following actions:

- Press the power door unlock button within the 20-second pre-armed mode.
- Unlock the doors with the remote control or keyless entry keypad. If equipped with intelligent access, you can use the unlock sensor on the exterior door handle. See **Locking and Unlocking** (page 67).
- Switch the ignition on or start your vehicle.
- Use a key in the driver door lock cylinder to unlock your vehicle, then switch the ignition on within 12 seconds.

**Note:** *Pressing the panic button on the remote control stops the horn and direction indicators, but does not disarm the system.*

# Power Running Boards (If Equipped)

## USING POWER RUNNING BOARDS

### WARNINGS



In extreme climates, excessive ice buildup may occur, causing the running boards not to deploy. Make sure that the running boards have deployed, and have finished moving before attempting to step on them. The running boards will resume normal function once the blockage is cleared.



Switch off the running boards before jacking or placing any object under your vehicle. Never place your hand between the extended running board and your vehicle. A moving running board may cause injury.

**Note:** Do not use the running boards, front and rear hinge assemblies, running board motors, or the running board underbody mounts to lift your vehicle when jacking. Always use proper jacking points.

**Note:** The running boards may operate more slowly in cool temperatures.

**Note:** The running board mechanism may trap debris such as mud, dirt, snow, ice and salt. This may cause unwanted noise. If this happens, manually set the running boards to the deployed position. Then, wash the system, in particular the front and rear hinge arms, with a high-pressure car wash wand.

## Automatic Power Deploy

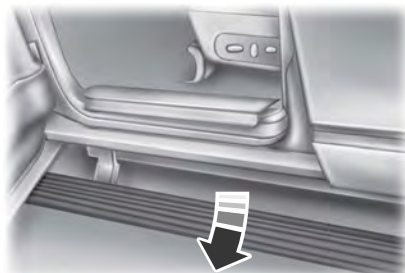

E166682

The running boards automatically extend down and out when you open the door. This can help you enter and exit your vehicle.

## Automatic Power Stow

When you close the doors, the running boards return to the stowed position after a two-second delay.

## Manual Power Deploy

You can manually operate the running boards in the information display.

1. Select **Settings**.
2. Select **Advanced Settings**.
3. Select **Vehicle**.
4. Select **Power Running Boards**.
5. Select your desired power running board setting.

Set the running boards in the deployed position to access the roof.

The running boards return to the stowed position and enter automatic mode when the vehicle speed exceeds 3 mph (5 km/h).

# Power Running Boards (If Equipped)

---

## Enabling and Disabling

You can enable and disable the power running board feature in the information display.

- When disabled, the running boards move to the stowed position regardless of the door position.
- When enabled, the running boards move back to the correct positions based on the door position.

## Bounce-back

The running board will reverse direction and move to the end of travel if it encounters an object while moving.

# Steering Wheel

## ADJUSTING THE STEERING WHEEL - VEHICLES WITH: MANUAL ADJUSTABLE STEERING COLUMN

### WARNING

 Do not adjust the steering wheel when your vehicle is moving.

**Note:** Make sure that you are sitting in the correct position. See **Sitting in the Correct Position** (page 154).

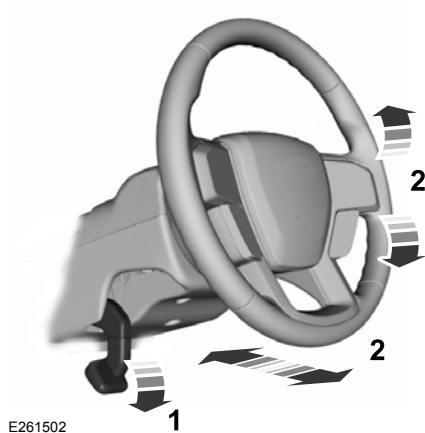

E261502

1. Unlock the steering column.
2. Adjust the steering wheel to the desired position.



E261503

3. Lock the steering column.

## ADJUSTING THE STEERING WHEEL - VEHICLES WITH: POWER ADJUSTABLE STEERING COLUMN

### WARNING

 Do not adjust the steering wheel when your vehicle is moving.

**Note:** Make sure that you are sitting in the correct position. See **Sitting in the Correct Position** (page 154).

# Steering Wheel



E261582

Use the control on the side of the steering column to adjust the position.

To adjust:

- Tilt: Press the top or bottom of the control.
- Telescope: Press the front or rear of the control.

## End of Travel Position

The steering column sets a stopping position just short of the end of the column position to prevent damage to the steering column. A new stopping position sets if the steering column encounters an object when tilting or telescoping.

To reset the steering column to its normal stopping position:

1. Confirm there is nothing obstructing the motion of the steering column.
2. Press and hold the steering column control until the steering column stops moving.
3. Press the steering column control again.

**Note:** *The steering column may begin to move again.*

4. When the steering column stops, continue holding the control for a few seconds.
5. Repeat for each direction as necessary.

A new stopping position sets. The next time you tilt or telescope the steering column, it stops just short of the end of the column position.

## Memory Feature

You can save and recall the steering column position with the memory function. See **Memory Function** (page 159).

Pressing the adjustment control during a memory recall cancels the operation.

## Easy Entry and Exit Feature

The column moves up when you switch the ignition off. Switch the ignition on to return the system to its previous settings. You can switch this feature on or off in the information display. See **Information Displays** (page 113).

**Note:** *Depending on your vehicle, the column may move up and in.*

## AUDIO CONTROL

You can operate the following functions with the control:

# Steering Wheel

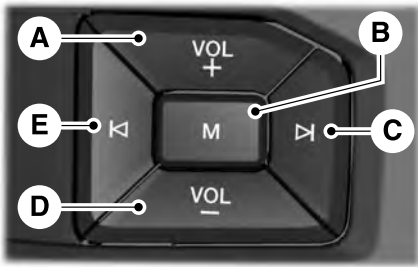

E191327

- A Volume up.
- B Media.
- C Seek up or next.
- D Volume down.
- E Seek down or previous.

## Media

Press repeatedly to scroll through available audio modes.

## Seek, Next or Previous

Press the seek button to:

- Tune the radio to the next or previous stored preset.
- Play the next or previous track.

Press and hold the seek button to:

- Tune the radio to the next station up or down the frequency band.
- Seek through a track.

## VOICE CONTROL (If Equipped)

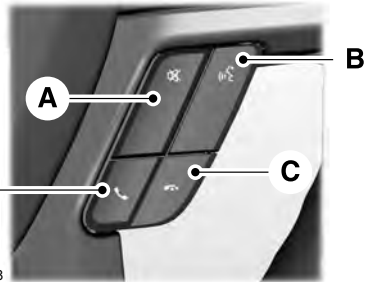

E191328

- A Mute.
- B Voice recognition.
- C End call.
- D Answer or make a call.

See your SYNC information.

## CRUISE CONTROL (If Equipped)

### Type One



E191329

See **Using Cruise Control** (page 243).

# Steering Wheel

## Type Two



E191337

See **Using Adaptive Cruise Control** (page 244).

**Note:** You can use the heated steering wheel only when the engine is running.

**Note:** The system uses a sensor and is designed to control the temperature of the steering wheel and to prevent it from overheating.

**Note:** In warm temperatures, the steering wheel quickly reaches its maximum temperature and the system reduces the current to the heating element. This could cause you to think that the system has stopped working but it has not. This is normal.

## INFORMATION DISPLAY CONTROL



E191336

See **Information Displays** (page 113).

## HEATED STEERING WHEEL (if Equipped)

Switch the heated steering wheel on and off using the touchscreen.



Touch the button to switch the heated steering wheel on and off.



# Pedals (If Equipped)

## ADJUSTING THE PEDALS

### WARNING



Never use the pedal adjustment controls when your feet are on the accelerator or brake pedal when the vehicle is moving.

**Note:** *Adjust the pedals only when your vehicle is in park (P).*

Depending on your vehicle and equipment level, the shape and location of your power-adjustable pedal control can vary.

- If your control is vertical, then it is to the left of the steering column and on the instrument panel.
- If your control is horizontal, then it is on the left side of the steering column.

### Vertical Control

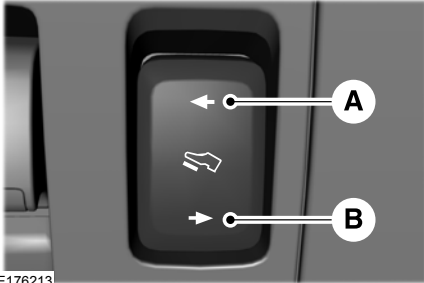

E176213

- A. Farther.
- B. Closer.

### Horizontal Control

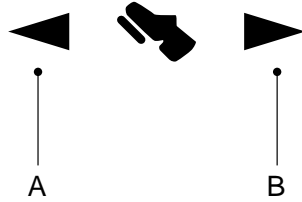

E162916

- A. Farther.
- B. Closer.

Both horizontal and vertical controls operate the same way:

1. Press and hold A to move the pedals away from you.
2. Press and hold B to move the pedals closer to you.

You can save and recall the pedal positions with the memory feature. See **Memory Function** (page 159).

# Wipers and Washers

## WINDSHIELD WIPERS

**Note:** Fully defrost the windshield before you switch the windshield wipers on.

**Note:** Make sure you switch the windshield wipers off before entering a car wash.

**Note:** If streaks or smears appear on the windshield, clean the windshield and the wiper blades. If that does not resolve the issue, install new wiper blades.

**Note:** Do not operate the wipers on a dry windshield. This may scratch the glass, damage the wiper blades or cause the wiper motor to burn out. Always use the windshield washers before wiping a dry windshield.

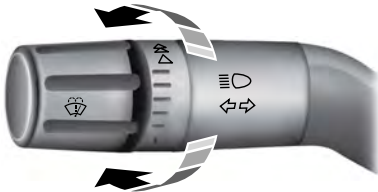

E172816

- Rotate away from you for a long wipe interval.
- Rotate toward you for a short wipe interval.

## Speed Dependent Wipers

When your vehicle speed increases, the interval between wipes decreases.

## AUTOWIPERS (If Equipped)

**Note:** Fully defrost the windshield before you switch the windshield wipers on.

**Note:** Make sure you switch the windshield wipers off before entering a car wash.

**Note:** If streaks or smears appear on the windshield, clean the windshield and the wiper blades. If that does not resolve the issue, install new wiper blades.

**Note:** The courtesy wipe feature turns on after using the windshield washers to remove any excess washer fluid and debris. You can adjust the courtesy wipe settings in the instrument display.

Wet or winter driving conditions with ice, snow or salty road mist can cause inconsistent and unexpected wiping or smearing.

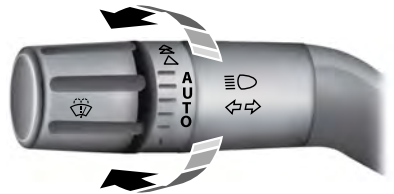

E172817

Use the rotary control to adjust the sensitivity of the autowipers. When you select low sensitivity, the wipers operate when the sensor detects a large amount of water on the windshield. When you select high sensitivity, the wipers operate when the sensor detects a small amount of water on the windshield.

Keep the outside of the windshield clean. The rain sensor is very sensitive and the wipers may operate if dirt, mist or insects hit the windshield.

# Wipers and Washers

---

In these conditions, you can do the following:

- Lower the sensitivity of the autowipers to reduce the amount of smearing on the windshield.
- Switch to normal or high-speed wipe.
- Switch autowipers off.

## WINDSHIELD WASHERS

**Note:** Do not operate the wipers on a dry windshield. This may scratch the glass, damage the wiper blades or cause the wiper motor to burn out. Always use the windshield washer before wiping a dry windshield.

**Note:** Do not operate the washers when the washer reservoir is empty. This may cause the washer pump to overheat.



E172818

- A brief press causes a single wipe without washer fluid.
- A brief press and hold causes the wipers to swipe three times with washer fluid.
- A long press and hold turns on the wipers and washer fluid for up to 10 seconds.

A wipe occurs a few seconds after washing to clear any remaining washer fluid. You can switch this feature on or off in the information display.

# Lighting

## GENERAL INFORMATION

### Condensation in the Exterior Front Lamps and Rear Lamps

Exterior front lamps and rear lamps have vents to accommodate normal changes in air pressure.

Condensation can be a natural by-product of this design. When moist air enters the lamp assembly through the vents, there is a possibility that condensation can occur when the temperature is cold. When normal condensation occurs, a fine mist can form on the interior of the lens. The fine mist eventually clears and exits through the vents during normal operation.

Clearing time may take as long as 48 hours under dry weather conditions.

Examples of acceptable condensation are:

- The presence of a fine mist (no streaks, drip marks or large droplets).
- A fine mist covers less than 50% of the lens.

Examples of unacceptable condensation are:

- A water puddle inside the lamp.
- Streaks, drip marks or large droplets present on the interior of the lens.

If you see any unacceptable condensation, have your vehicle checked by an authorized dealer.

## LIGHTING CONTROL

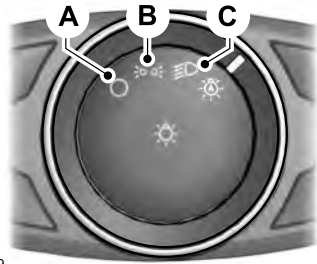

E142449

- A Off.
- B Parking lamps, instrument panel lamps, license plate lamps and rear lamps.
- C Headlamps.

### Headlamp High Beam

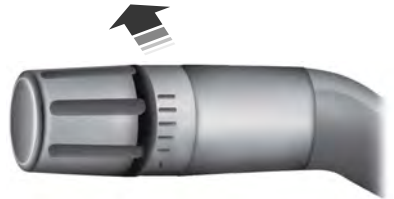

E167827

Push the lever away from you to switch the high beam on.

Push the lever forward again or pull the lever toward you to switch the high beams off.

# Lighting

## Headlamp Flasher

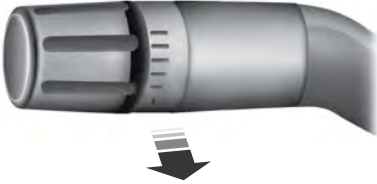

E163268

Slightly pull the lever toward you and release it to flash the headlamps.

## AUTOLAMPS (If Equipped)

### WARNING



The system does not relieve you of your responsibility to drive with due care and attention. You may need to override the system if it does not turn the headlamps on in low visibility conditions, for example daytime fog.

The headlamps remain on for a period of time after you switch the ignition off. Use the information display controls to adjust the period of time that the headlamps remain on.

**Note:** *If you switch the autolamps on, you cannot switch the high beams on until the system turns the low beams on.*

## Windshield Wiper Activated Headlamps

When you switch the autolamps on, the headlamps turn on within 10 seconds of switching the wipers on. They turn off approximately 60 seconds after you switch the windshield wipers off.

The headlamps do not turn on with the wipers:

- During a single wipe.
- When using the windshield washers.
- If the wipers are in intermittent mode.

**Note:** *If you switch the autolamps and the autowipers on, the headlamps turn on when the windshield wipers continuously operate.*

## INSTRUMENT LIGHTING DIMMER

**Note:** *When disconnecting the battery or when it runs out of charge, the illuminated components turn to the maximum setting.*

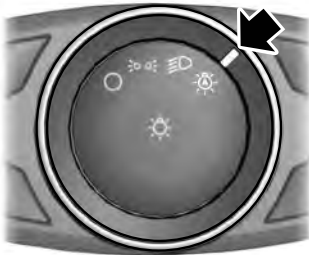

E142451

When the lighting control is in the autolamps position, the headlamps turn on in low light situations, or when the wipers turn on.

# Lighting

## Vehicles With Front Fog Lamps

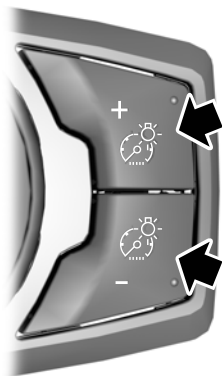

E231828

Press repeatedly or press and hold until you reach the desired level.

## Vehicles Without Front Fog Lamps



E165366

- A Press repeatedly or press and hold to dim.
- B Press repeatedly or press and hold to brighten.

## DAYTIME RUNNING LAMPS

### WARNING



The daytime running lamps system does not activate the rear lamps and may not provide adequate lighting during low visibility driving conditions. Make sure you switch the headlamps on, as appropriate, during all low visibility conditions. Failure to do so may result in a crash.

### Type One - Conventional (Non-Configurable)

The daytime running lamps turn on when:

1. Switching the ignition on.
2. The transmission is not in park (P) for vehicles with automatic transmissions, or releasing the parking brake for vehicles with manual transmissions.
3. The lighting control is in the off, parking lamp or autolamps positions.
4. The headlamps are off.

### Type Two - Configurable

Switch the daytime running lamps on or off using the information display. See **Information Displays** (page 113).

The daytime running lamps turn on when:

1. The lamps are on in the information display.
2. Switching the ignition on.
3. The transmission is not in park (P) for vehicles with automatic transmissions, or releasing the parking brake for vehicles with manual transmissions.
4. The lighting control is in the autolamps position.
5. The headlamps are off.

The other lighting control switch positions do not turn on the daytime running lamps.

# Lighting

If the daytime running lamps are off in the information display, the lamps stay off in all switch positions.

## AUTOMATIC HIGH BEAM CONTROL (If Equipped)

### WARNING



The system does not relieve you of your responsibility to drive with due care and attention. You may need to override the system if it does not turn the high beams on or off.

The system turns on high beams if it is dark enough and no other traffic is present. If it detects an approaching vehicle's headlamps or tail lamps, or street lighting ahead, the system turns off high beams before they can distract other road users. Low beams remain on.

**Note:** The system may not operate properly if the sensor is blocked. Keep the windshield free from obstruction or damage.

**Note:** The system may not operate properly in cold or inclement conditions. You can switch on the high beams by overriding the system.

**Note:** If the system detects a blockage, for example bird droppings, bug splatter, snow or ice, the system goes into low beam mode until you clear the blockage. A message may appear in the information display if the camera is blocked.

**Note:** Using much larger tires or equipping vehicle accessories such as snowplows can modify your vehicle's ride height and degrade automatic high beam control performance.

A camera sensor, centrally mounted behind the windshield of your vehicle, continuously monitors conditions to turn the high beams on and off.

Once the system is active, the high beams turn on if:

- The ambient light level is low enough.
- There is no traffic in front of your vehicle.
- The vehicle speed is greater than approximately 32 mph (51 km/h).

The high beams turn off if:

- The ambient light level is high enough that high beams are not required.
- The system detects an approaching vehicle's headlamps or tail lamps.
- The vehicle speed falls below approximately 27 mph (44 km/h).
- The system detects severe rain, snow or fog.
- The camera is blocked.

## Switching the System On and Off

Switch the system on using the information display. See **Information Displays** (page 113).

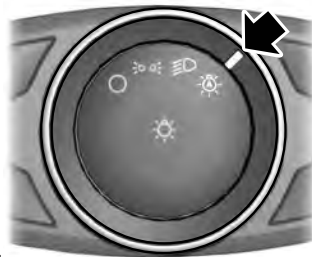

E142451

Switch the lighting control to the autolamps position. See **Autolamps** (page 90).

## Overriding the System

When you switch on the high beams, pushing or pulling the stalk provides a temporary override to low beam.

# Lighting

## Automatic High Beam Indicator (If Equipped)



The indicator lamp illuminates to confirm when the system is ready to assist.

- To operate the left direction indicator, push the lever down until it stops.
- To operate the right direction indicator, push the lever up until it stops.

**Note:** Tap the lever up or down to make the direction indicators flash three times.

## FRONT FOG LAMPS (If Equipped)



E142453

Press the control to switch the fog lamps on or off.

You can switch the fog lamps on when the lighting control is in any position except Off and the high beams are not on.

## DIRECTION INDICATORS



E163272

## SPOT LAMPS (If Equipped)

The spot lamps are on the forward-facing side of the exterior mirrors. Switch on the spot lamps by pressing the buttons above the lighting control with the parking lamps on.



E176842

When switching on the spot lamps, the area in front of and to the side of your vehicle illuminates.

Adjust the aim of the spot lamps by moving the position of the exterior mirrors.

For manual folding mirrors, adjust the aim of the lamps by folding the exterior mirrors into or away from the windows. For power-folding mirrors, use the switch on the driver-side door.

**Note:** The spot lamps turn off when you reach a speed of 6 mph (10 km/h).



# Lighting

## Cargo and Trailer Hookup Lamps

(If Equipped)

The cargo lamps are in the central high mounted stop lamp, and to either side of the cargo box.

The trailer hookup lamp is on the tailgate next to the handle.



Pressing the button in the lighting control panel or the button in the cargo box near the lamp turns on both of these lamps.



E190880

If you switch on the cargo lamps, the cargo and trailer hitch area illuminate.

**Note:** The cargo and trailer hookup lamps turn off when you reach a speed of 3 mph (5 km/h). They also turn off after 10 minutes, fading gradually to off.

## INTERIOR LAMPS

The lamps turn on under the following conditions:

- You open any door.
- You press a remote control button.

### Front Interior Lamps

**Note:** The front interior lamp switches are on the overhead console. The exact location of each button on the overhead console depends upon your vehicle features.

**Note:** Press the button to switch the door function off when you open any door. When the door function is off and you open a door, the courtesy and door lamps stay off. The indicator lamp lights amber when the door function is off.

**Note:** Press the button again to switch the door function back on. When the door function is on and you open a door, the courtesy and door lamps turn on. The indicator lamp lights blue when the door function is on.

# Lighting

## Type One

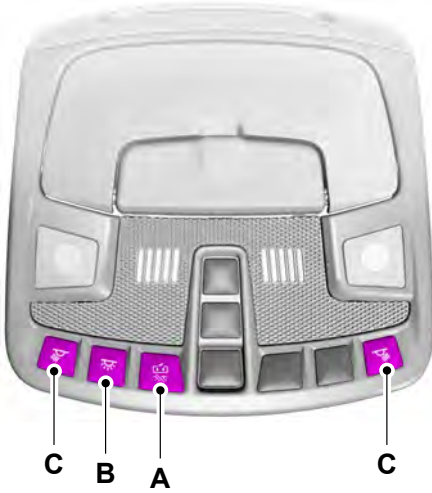

E199032

- A. Door function.
- B. All lamps on.
- C. Map lamps.

## Type Two

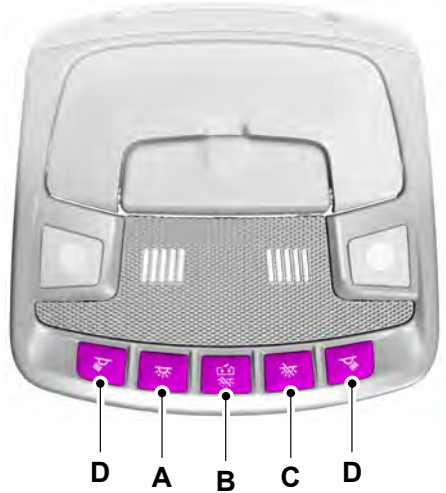

E192153

- A. All lamps on.
- B. Door function.
- C. All lamps off.
- D. Map lamps.

# Lighting

## Type Three



E201073

- A. Map lamp.
- B. Door function.
- C. All lamps off.
- D. Map lamp.



E187342

- A. All lamps on.
- B. Door function.

## Rear Interior Lamps (If Equipped)

### Type One

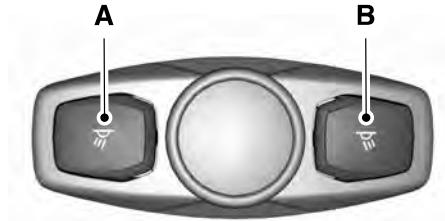

E182517

- A. Individual lamp.
- B. Individual lamp.

### Type Two



E187343

### Type Three



E187345

# Lighting

---

Press the button to switch the lamps on or off.

## **AMBIENT LIGHTING** (If Equipped)

Adjust the ambient lighting using the touchscreen. See your SYNC information.

## **CARGO LAMPS**



Press the button in the lighting control panel or in the rear cargo box to switch on the lamps.



E190880

The cargo lamps are in the following areas:

- Either side of the cargo box.
- Next to the tailgate handle.

**Note:** *The cargo lamps turn off when you reach a speed of 3 mph (5 km/h). They also turn off after 10 minutes, fading gradually to off.*

# Windows and Mirrors

## POWER WINDOWS (If Equipped)

### WARNINGS

 Do not leave children unattended in your vehicle and do not let them play with the power windows. They may seriously injure themselves.

 When closing the power windows, you should verify they are free of obstructions and make sure that children and pets are not in the proximity of the window openings.

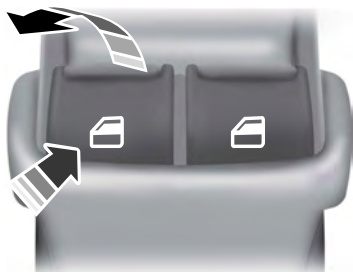

E176215

Press the control to open the window.  
Lift the control to close the window.

**Note:** You may hear a pulsing noise when just one of the windows is open. Lower the opposite window slightly to reduce this noise.

### One-Touch Up or Down (If Equipped)

Press or lift the switch fully and release it.  
Press or lift it again to stop the window.

**Note:** The window may disable for up to five minutes if you cycle it up and down repeatedly. This helps prevent damage to the motor. Normal operation will resume once the motor cools.

### Restoring the One-Touch Up Function

You may lose the one-touch function if the vehicle battery is low.

To reset the function after the battery recharges:

1. Pull the switch all the way up.
2. Hold the switch until the glass stops and continue to hold for two seconds.
3. Press the switch down and operate the window to the full down position. One-touch up will now be functional.

**Note:** Perform one-touch up re-calibration with the door closed. Calibrating with the door open will cause the window to continuously bounce back.

### Bounce-Back (If Equipped)

The window will automatically stop and reverse some distance if it detects an obstacle while closing.

### Overriding the Bounce-Back Feature

#### WARNING

 When you override the bounce-back feature the window will not reverse if it detects an obstacle. Take care when closing the windows to avoid personal injury or damage to your vehicle.

Pull up the window switch and hold within two seconds of the window reaching the bounce-back position. The window will travel up with no bounce-back protection. The window will stop if you release the switch before the window closes fully.

# Windows and Mirrors

## Window Lock (If Equipped)



E176216

Press the control to lock or unlock the rear window controls.

## Accessory Delay (If Equipped)

The window switches remain operational for several minutes when you switch the ignition off or until you open either front door.

## GLOBAL OPENING (If Equipped)

You can use the remote control to open the windows with the ignition off.

**Note:** To operate this feature, accessory delay must not be active.

## Opening the Windows

You can only open the windows for a short time after you unlock your vehicle with the remote control. After you unlock your vehicle, press and hold the remote control unlock button to open the windows. Release the button once movement starts. Press the lock or unlock button to stop movement.

## EXTERIOR MIRRORS

### Power Exterior Mirrors (If Equipped)

#### WARNING



Do not adjust the mirrors when your vehicle is moving. This could result in the loss of control of your vehicle, serious personal injury or death.



E144073

- A Left-hand mirror.
- B Adjustment control.
- C Right-hand mirror.

To adjust your mirrors, switch your vehicle on, with the ignition in accessory mode or the engine running, and then:

1. Select the mirror you want to adjust. The control lights.
2. Use the adjustment control to adjust the position of the mirror.
3. Press the mirror control again. The control light turns off.

## Fold-Away Exterior Mirrors

Push the mirror toward the door window glass. Make sure that you fully engage the mirror in its support when returning it to its original position.

# Windows and Mirrors

## Telescoping Mirrors

This feature lets you extend the mirror about 3 in (75 mm). It is useful when towing a trailer. You can manually pull out or push in the mirrors to the desired position.

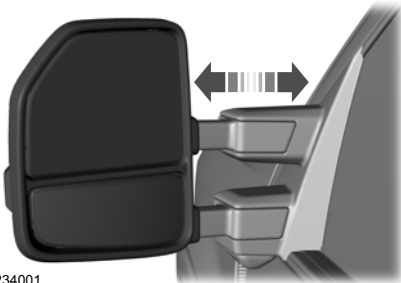

E234001

## PowerScope™ Power Telescoping Mirrors (If Equipped)

**Note:** Do not stop the mirrors midway through their movement. Wait until the mirrors stop moving and press the control again.

**Note:** The left-hand and right-hand mirrors move at different rates. For example, one mirror may stop while the other one continues to move. This is normal.

## Power-Folding Mirrors

To fold both mirrors:

1. Press the control.
2. Press control again to unfold the mirrors.



E234002

## Power Telescoping Mirrors

This feature lets you position both mirrors at the same time.



E218902

- A Extend.
- B Retract.

# Windows and Mirrors

To adjust your mirrors, press the adjustment control to position the mirrors.

**Note:** *Moving the mirrors 10 or more times within one minute, or repeated folding, unfolding and telescoping of the mirrors while holding the control down during full travel, may disable the system to protect the motors from overheating. Wait approximately three minutes with the vehicle running, and up to 10 minutes with the vehicle off, for the system to reset and for function to return to normal.*

## Loose Mirror

If your power-folding mirrors are manually folded, they may not work properly even after you re-position them. You need to reset them if:

- The mirrors vibrate when you drive.
- The mirrors feel loose.
- The mirrors do not stay in the folded or unfolded position.
- One of the mirrors is not in its normal driving position.

To reset the power-fold feature, use the power-folding mirror control to fold and unfold the mirrors. You may hear a loud noise as you reset the power-folding mirrors. This sound is normal. Repeat this process as needed each time the mirrors are manually folded.

## Heated Exterior Mirrors (If Equipped)

See **Heated Exterior Mirrors** (page 152).

## Memory Mirrors (If Equipped)

You can save and recall the mirror positions through the memory function. See **Memory Function** (page 159).

## Direction Indicator Mirrors (If Equipped)

While the vehicle is running, the forward-facing portion of the appropriate mirror housing blinks when you switch on the direction indicator.

## Puddle Lamps (If Equipped)

The lamps on the bottom part of the mirror housing light when you use your transmitter to unlock the doors or when you open a door.

## Clearance Lamps (If Equipped)

The lower, outer part of the mirror housings light when you switch the headlamps or parking lamps on.

## Spot Lamps (If Equipped)

The area lights are on the forward-facing portion of the mirror housing. You can switch them on and off by using the controls located on the instrument panel. See **Lighting** (page 89).

## Trailer Towing Camera System (If Equipped)

See **Rear View Camera** (page 236).

## Blind Spot Information System (If Equipped)

See **Blind Spot Information System** (page 252).

# INTERIOR MIRROR

## Manual Dimming Mirror

### WARNING



Do not adjust the mirrors when your vehicle is moving. This could result in the loss of control of your vehicle, serious personal injury or death.



# Windows and Mirrors

Pull the tab below the mirror toward you to reduce the effect of bright light from behind.

## Automatic Dimming Mirror (If Equipped)

### WARNING



Do not adjust the mirrors when your vehicle is moving. This could result in the loss of control of your vehicle, serious personal injury or death.

The mirror dims to reduce the effect of bright light from behind. It returns to normal when the bright light from behind is no longer present or if you shift into reverse (R).

Do not block the sensors on the front and back of the mirror.

**Note:** A rear center passenger or raised rear center head restraint could prevent light from reaching the sensor.

## SLIDING WINDOWS (If Equipped)

### Power Sliding Back Window (If Equipped)

#### WARNINGS



When operating the power sliding back window, you must make sure all rear seat occupants and cargo are not in the proximity of the back window.



Do not leave children unattended in your vehicle and do not let them play with the power sliding back window. They may seriously injure themselves.

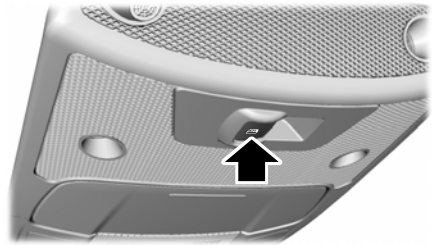

E176217

The control is on the overhead console.

Press and hold the control to open the window. Pull and hold the control to close the window.

## SUN VISORS

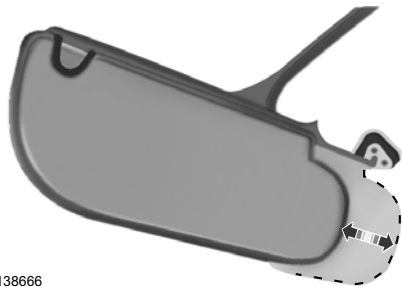

E138666

Rotate the sun visor toward the side window and extend it rearward for extra shade.

# Windows and Mirrors

## Illuminated Vanity Mirror (If Equipped)

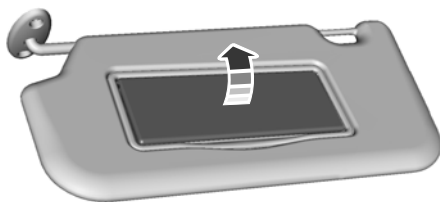

E162197

Lift the cover to switch the lamp on.

## MOONROOF (If Equipped)

### WARNINGS



Do not leave children unattended in your vehicle and do not let them play with the moonroof. They may seriously injure themselves.



When closing the moonroof, you should verify that it is free of obstructions and make sure that children and pets are not in the proximity of the roof opening.

The moonroof controls are located on the overhead console and have a one-touch open and close feature. To stop its movement during one-touch operation, press the control a second time.

## Opening and Closing the Moonroof

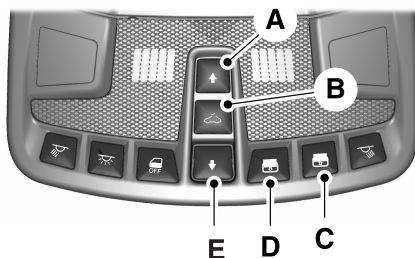

E191272

- A Moonroof open.
- B Moonroof vent.
- C Sunshade open.
- D Sunshade close.
- E Moonroof close.

### Moonroof Open

Press and release to open the moonroof.

**Note:** The moonroof stops short of the fully opened position to reduce wind noise or rumbling that may happen with the moonroof fully open. Press and release the control again to open the moonroof fully.

### Moonroof Vent

Press and release to vent the moonroof.

### Sunshade Open

Press and release to open the sunshade. The sunshade opens automatically with the moonroof. You can also open the sunshade with the moonroof closed.

**Note:** The sunshade stops short of its fully opened position for the comfort of rear passengers. To open the sunshade fully, press the control again.

# Windows and Mirrors

---

## **Sunshade Close**

Press and release to close the sunshade.

## **Moonroof Close**

Press and release to close the moonroof from either the open or vent positions.

## **Bounce-Back**

The moonroof automatically reverses some distance if an obstacle is detected while closing.

To override this feature, press and hold (E) within two seconds after the roof comes to a stop following a bounce-back reversal.

# Instrument Cluster

## GAUGES

### Type 1 and 2

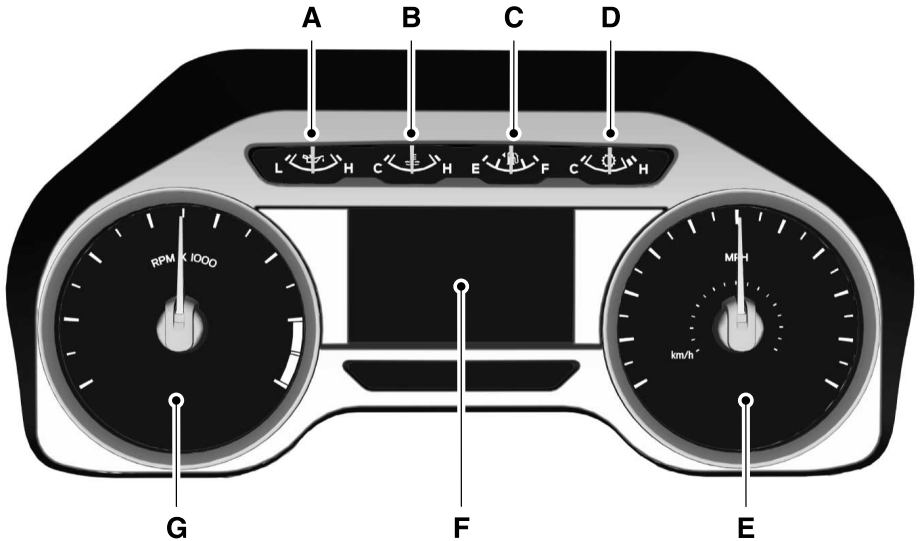

E219638

- |   |                                       |   |   |
|---|---------------------------------------|---|---|
| A | Engine oil pressure gauge.            | E | Speedometer.  |
| B | Engine coolant temperature gauge.     | F | Information display. See <b>General Information</b> (page 113). |
| C | Fuel gauge.                           | G | Tachometer.   |
| D | Transmission fluid temperature gauge. |   |   |

# Instrument Cluster

## Type 3

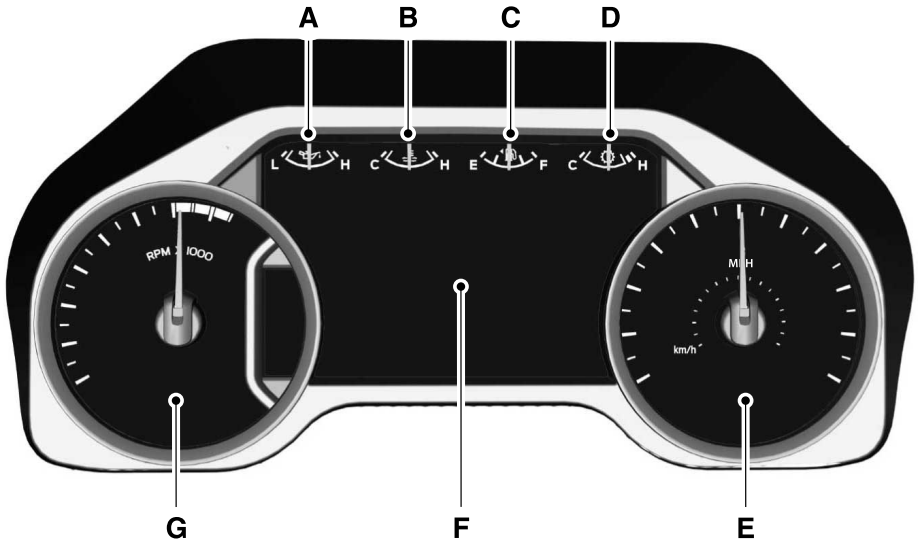

E219651

- A Engine oil pressure gauge.
- B Engine coolant temperature gauge.
- C Fuel gauge.
- D Configurable. Transmission fluid temperature, Turbo boost or DEF gauge (diesel engines only).
- E Speedometer.
- F Information display. See **General Information** (page 113).
- G Tachometer.

### Engine Oil Pressure Gauge

Indicates engine oil pressure. The needle should stay in the normal operating range (between L and H). If the needle falls below the normal range, stop your vehicle, turn off the engine and check the engine oil level. Add oil if needed. If the oil level is correct, have your vehicle checked by an authorized dealer.

# Instrument Cluster

## Engine Coolant Temperature Gauge

### WARNING



Do not remove the coolant reservoir cap when the cooling system is hot.

Wait 10 minutes for the cooling system to cool down. Cover the coolant reservoir cap with a thick cloth to prevent the possibility of scalding and slowly remove the cap. Failure to follow this instruction could result in personal injury.

Indicates engine coolant temperature. At normal operating temperature, the level indicator will be in the normal range. If the engine coolant temperature exceeds the normal range, stop your vehicle as soon as safely possible, switch off the engine and let the engine cool.

## Fuel Gauge

**Note:** *The fuel gauge may vary slightly when your vehicle is moving or on a gradient.*

Switch the ignition on. The fuel gauge will indicate approximately how much fuel is left in the fuel tank. The arrow adjacent to the fuel pump symbol indicates on which side of your vehicle the fuel filler door is located.

### Variations:

**Note:** *The distance-to-empty warning can appear at different fuel gauge positions depending on fuel economy conditions. This variation is normal.*

Driving type (fuel economy conditions)	Distance-to-empty	Fuel gauge position
Highway driving	50 mi (80 km)	1/8th tank
Severe duty driving (trailer towing, extended idle)	50 mi (80 km)	1/4 tank

The needle should move toward F when you refuel your vehicle. If the needle points to E after adding fuel, this indicates your vehicle needs service soon.

After refueling some variability in needle position is normal:

- It may take a short time for the needle to reach F after leaving the gas station. This is normal and depends upon the slope of pavement at the gas station.
- The fuel amount dispensed into the tank is a little less or more than the gauge indicated. This is normal and depends upon the slope of pavement at the gas station.
- If the gas station nozzle shuts off before the tank is full, try a different gas pump nozzle.

### Low Fuel Reminder

A low fuel reminder triggers when the distance to empty value reaches 50 mi (80 km) to empty, with additional warnings at 25 mi (40 km), 10 mi (20 km) and 0 mi (0 km) to empty, provided the message is cleared each time. An additional warning at 75 mi (120 km) to empty is provided when the MyKey is being used.

# Instrument Cluster

## Transmission Fluid Temperature Gauge

Indicates transmission fluid temperature. At normal operating temperature, the level indicator will be in the normal range. If the transmission fluid temperature exceeds the normal range, stop the vehicle as soon as safely possible and verify the airflow is not restricted such as snow or debris blocking airflow through the grill. Also, higher than normal operating temperature can be caused by special operation conditions (i.e. snowplowing, towing or off-road use). Operating the transmission for extended periods with the gauge in the higher than normal area may cause internal transmission damage. You need to alter the severity of your driving conditions to lower the transmission temperature into the normal range. If the gauge continues to show high temperatures, see an authorized dealer.

## Turbo Boost Gauge (If Equipped)

Indicates the amount of manifold air pressure in the engine.

## DEF Gauge (If Equipped)

Indicates the current DEF level.

## WARNING LAMPS AND INDICATORS

The following warning lamps and indicators alert you to a vehicle condition that may become serious. Some lamps illuminate when you start your vehicle to make sure they work. If any lamps remain on after starting your vehicle, refer to the respective system warning lamp for further information.

**Note:** Some warning indicators appear in the information display and operate the same as a warning lamp but do not illuminate when you start your vehicle.

## Adaptive Cruise Control (If Equipped)



The speed control system indicator light changes color to indicate what mode the system is in. See **Using Adaptive Cruise Control** (page 244).

**On (white light):** Illuminates when the adaptive cruise control system is turned on. Turns off when the speed control system is turned off.

**Engaged (green light):** Illuminates when the adaptive cruise control system is engaged. Turns off when the speed control system is disengaged.

## Adaptive Steering (If Equipped)



The adaptive steering system indicator illuminates if the system detects a fault during the continuous diagnostic checks.

**Adaptive Steering Initialization (yellow, flashing):** The adaptive steering system has detected a difference between steering wheel angle and the desired road wheel angle. The steering wheel adjusts itself to correct this difference. This adjustment is part of normal system operation.

**Adaptive Steering Off (yellow, solid):** The adaptive steering system is off. It is possible that the steering wheel may not be straight when the vehicle is driving straight ahead. If this message persists, see an authorized dealer.

# Instrument Cluster

Adaptive Steering Loss (red, solid): The adaptive steering system integrity cannot be verified. Do not drive the vehicle and contact an authorized dealer immediately. See **Steering** (page 259).

## Anti-Lock Braking System



It illuminates momentarily when you switch on the ignition to confirm that the lamp is functional. If it does not illuminate when you switch on the ignition or begins to flash at anytime, have the system checked as soon as possible.

If it illuminates when you are driving, this indicates a malfunction. You will continue to have the normal braking system (without ABS) unless the brake system warning lamp is also illuminated. Have the system checked as soon as possible.

## Automatic High Beam (If Equipped)



Illuminates when this feature is on. See **Automatic High Beam Control** (page 92).

## Battery



If it illuminates while driving, it indicates a malfunction. Switch off all unnecessary electrical equipment and have the system checked by your authorized dealer immediately.

## Brake System

### WARNING



Driving your vehicle with the warning lamp on is dangerous. A significant decrease in braking performance may occur. It may take you longer to stop your vehicle. Have your vehicle checked as soon as possible. Driving extended distances with the parking brake engaged can cause brake failure and the risk of personal injury.



It illuminates momentarily when you switch on the ignition to confirm that the lamp is functional. If it does not illuminate when you switch on the ignition or begins to flash at anytime, have the system checked as soon as possible.

Illuminates when you engage the parking brake with the ignition on.

If it illuminates when you are driving, check that the parking brake is not engaged. If the parking brake is not engaged, this indicates low brake fluid level or a brake system malfunction. Have the system checked as soon as possible.

## Blind Spot Monitor (If Equipped)



It illuminates when you switch this feature off or in conjunction with a message. See **Blind Spot Information System** (page 252).

## Check Fuel Cap (If Equipped)



Illuminates when the fuel cap may not be properly installed. Continued driving with this light on may cause the Service engine soon warning indicator to come on.



# Instrument Cluster

## Cruise Control (If Equipped)



Illuminates when you switch this feature on. See **Using Cruise Control** (page 243).

## Direction Indicator



Illuminates when the left or right turn signal or the hazard warning flasher is turned on. If the indicators stay on or flash faster, check for a burned out bulb.

## Door Ajar



Displays when the ignition is on and any door is not completely closed.

## Electronic Locking Differential (If Equipped)



Illuminates when using the electronic locking differential.

## Engine Coolant Temperature



Illuminates when the engine coolant temperature is high. Stop the vehicle as soon as possible, switch off the engine and let cool.

## Engine Oil



If it illuminates with the engine running or when you are driving, this indicates a malfunction.

Stop your vehicle as soon as it is safe to do so and switch the engine off. Check the engine oil level.

See **Engine Oil Check** (page 333).

**Note:** Do not resume your journey if it illuminates despite the level being correct. Have the system checked by your authorized dealer immediately.

## Fasten Seatbelt



It illuminates and a chime sounds to remind you to fasten your seatbelt.

## Front Airbag



If it fails to illuminate when you start your vehicle, continues to flash or remains on, it indicates a malfunction. Have the system checked by your authorized dealer.

## Front Fog Lamps (If Equipped)



It illuminates when you switch the front fog lamps on.

## High Beam



Illuminates when you switch the high beam headlamps on. It will flash when you use the headlamp flasher.

## Hill Descent (If Equipped)



Illuminates when hill descent is switched on.

## Low Fuel Level



Illuminates when the fuel level is low or the fuel tank is nearly empty. Refuel as soon as possible.

## Low Tire Pressure Warning



It illuminates if the tire pressure in one or more tires is below the correct tire pressure.

# Instrument Cluster

It also illuminates momentarily when you switch the ignition on to confirm the lamp is functional. If it does not illuminate when you switch the ignition on, or begins to flash at any time, have the system checked by your authorized dealer.

## Powertrain Malfunction/Reduced Power/Electronic Throttle Control



Illuminates when a powertrain or a 4WD fault has been detected. Contact your authorized dealer as soon as possible.

## Service Engine Soon



If it illuminates when the engine is running this indicates a malfunction. The On Board Diagnostics system has detected a malfunction of the vehicle emission control system.

If it flashes, engine misfire may be occurring. Increased exhaust gas temperatures could damage the catalytic converter or other vehicle components. Drive in a moderate fashion (avoid heavy acceleration and deceleration) and have your vehicle immediately serviced.

It illuminates when you switch the ignition on prior to engine start to check the bulb and to indicate whether your vehicle is ready for Inspection and Maintenance (I/M) testing.

Normally, it illuminates until the engine is cranked and automatically turns off if no malfunctions are present. However, if after 15 seconds it flashes eight times, this indicates that your vehicle is not ready for Inspection and Maintenance (I/M) testing. See **Emission Law** (page 195).

## Stability Control



Illuminates when the system is active. If it remains illuminated or does not illuminate when you switch the ignition on, this indicates a malfunction. During a malfunction the system will switch off. Have the system checked by your authorized dealer immediately. See **Using Stability Control** (page 231).

## Stability Control Off



Illuminates when you switch the system off. It will go out when you switch the system back on or when you switch the ignition off.

See **Using Stability Control** (page 231).

## Transmission Tow/Haul (If Equipped)



Illuminates when the tow/haul feature has been activated. If the light flashes steadily, have the system serviced immediately, damage to the transmission could occur.

## 4X2 (If Equipped)



Illuminates momentarily when two-wheel drive high is selected. If the light fails to display when the ignition is turned on, or remains on, have the system serviced immediately by your authorized dealer.

## 4X4 LOW (If Equipped)



Illuminates when four-wheel drive low is engaged. If the light fails to display when the ignition is turned on, or remains on, have the system serviced immediately by your authorized dealer.

# Instrument Cluster

## 4X4 HIGH (If Equipped)



Illuminates when four-wheel drive high is engaged. If the light fails to display when the ignition is turned on, or remains on, have the system serviced immediately by your authorized dealer.

## Diesel Engine Brake (If Equipped)



Illuminates when you switch the manual engine brake on. See **General Information** (page 225).



Illuminates when you switch the automatic engine brake on. See **General Information** (page 225).

## Diesel Exhaust Fluid (If Equipped)



With the key in the on position, illuminates when the DEF is contaminated, low or someone has tampered with the DEF system. See **Selective Catalytic Reductant System** (page 198).

## Wait To Start (If Equipped)



Illuminates when you switch the ignition on as part of the pre-start system. Wait until the wait to start indicator turns off before attempting to start vehicle. See **Starting a Diesel Engine** (page 178).

## Water In Fuel (If Equipped)

### WARNING



Do not drain the water-in-fuel separator while the engine is running. Failure to follow this warning may result in fire, serious injury, death or property damage.



During refueling, it is possible for you to pump water-contaminated diesel fuel into your fuel tank. Your vehicle's fuel system is equipped with a fuel filter and water separator to remove water from the fuel. The water in fuel indicator lights when the fuel and water separator has a significant quantity of water in it and requires immediate draining.

If the water in fuel indicator illuminates when the engine is running, stop your vehicle as soon as safely possible, shut off the engine, then drain the fuel and water separator. See **Fuel Quality** (page 187). Allowing water to stay in the fuel system, after the water in fuel indicator illuminates, could result in extensive damage or failure of the fuel injection system.

**Note:** *Do not drain the fuel and water separator while the engine is running. Air will enter into the fuel system causing the engine not to operate properly.*

## AUDIBLE WARNINGS AND INDICATORS

### Headlamps On Warning Chime

Sounds when you remove the key from the ignition and open the driver's door and you have left the headlamps or parking lamps on.

### Key in Ignition Warning Chime

Sounds when you open the driver's door and you have left the key in the ignition.

### Parking Brake On Warning Chime

Sounds when you have left the parking brake on and drive your vehicle. If the warning chime remains on after you have released the parking brake, have the system checked by your authorized dealer immediately.

# Information Displays

## GENERAL INFORMATION

### WARNING



Driving while distracted can result in loss of vehicle control, crash and injury. We strongly recommend that you use extreme caution when using any device that may take your focus off the road. Your primary responsibility is the safe operation of your vehicle. We recommend against the use of any hand-held device while driving and encourage the use of voice-operated systems when possible. Make sure you are aware of all applicable local laws that may affect the use of electronic devices while driving.

Various systems on your vehicle can be controlled using the information display controls on the steering wheel. Corresponding information is displayed in the information display.

**Note:** Some options may appear slightly different or not at all if the items are optional.

**Note:** Trailer options are not available if your vehicle speed is greater than 3 mph (5 km/h).

**Note:** Some MyKey menu options only appear if MyKey is enabled and at least one MyKey is programmed.



This icon gives you the ability to switch a feature on or off. A check in the box indicates the feature is enabled, and unchecked indicates the feature is disabled.

## Information Display Controls (Type 1 and 2) (If Equipped)

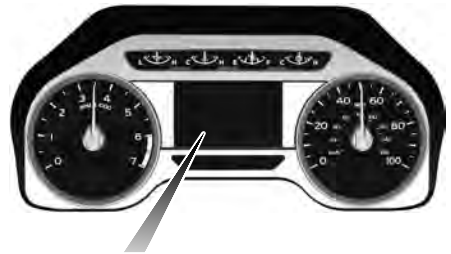

E219650

- Press the up and down arrow buttons to scroll through and highlight the options within a menu.
- Press the right arrow button to enter a sub-menu.
- Press the left arrow button to exit a menu.
- Press the **OK** button to choose and confirm a setting or messages.

# Information Displays

---

## Type 1

Main Menu
Trip 1
Trip 2
Fuel Economy
Driver Assist
Settings

Trip 1
Digital Speed
Trip Odometer
Trip Timer
DTE
Average Fuel
Outside Temp

- Digital Speed - Shows a digital display of your vehicle speed.
- Trip Odometer - Registers the mileage of individual trips.
- Trip Timer - Registers the time of individual trips.
- DTE - Shows the approximate distance your vehicle can travel before running out of fuel.
- Average Fuel - Shows the average fuel economy for a given trip.
- Outside Air - Shows the outside air temperature.

**Note:** Press and hold OK to reset values.

**Note:** Trip 2 information is the same as Trip 1.

# Information Displays

<b>Fuel Economy</b>	
Distance to E	
Instant Fuel Economy	
Average Fuel Economy	

- Distance to E - Shows the approximate distance your vehicle can travel before running out of fuel.
- Instant Fuel Economy - Shows your instantaneous fuel usage.
- Average Fuel Economy - Shows the average fuel usage based on time.
- Average Speed - Shows the average speed the vehicle has driven.

**Note:** *Press and hold OK to reset values.*

<b>Driver Assist</b>	
DEF Gauge	
DEF Status	
Exhaust Filter	
Engine Hours	Engine Hours
	Engine Idle
Dual Fuel Tank	Front Tank
	Rear Tank
Hill Strt Asst.	
Oil Temp	Oil Temp
Tire Pressure	
Trans. Temp.	
Rear Park Aid	
Tr Brake Type	Select Your Setting
Tr Brake Effort	
Trailer Sway	

## Information Displays

<b>Settings</b>			
Vehicle	A. Engine Off		
	Auto Regen		
	DTE Calculate	Select Your Setting	
	Lighting	Autolamp Delay	Select Your Setting
		Daytime Light	
	Locks	Autolock	
		Autounlock	
		Remote Unlock	Select Your Setting
	Oil Life Reset	Follow onscreen directions to confirm or modify your settings	
	Alarm	Select Your Setting	
		Ask on Exit	
	Remote Start	Climate Control	Select Your Setting
		Seats	
		Duration	
System			
Windows	Remote Open		
Wiper Controls	Courtesy Wipe		
MyKey	MyKey Status	Shows information related to the configured MyKey(s).	
	Create MyKey	Follow onscreen directions to confirm or modify your settings.	
	911 Assist	Select Your Setting	
	Do Not Disturb		
	AdvanceTrac		
	Max Speed		
	Speed Minder		

# Information Displays

<b>Settings</b>		
	Vol. Limiter	
	Clear MyKeys	Follow onscreen directions to confirm or modify your settings.
Display Setup	Units	Select Your Setting
	Temperature	
	Language	
	Tire Pressure	

## Type 2

<b>Main Menu</b>
Display Mode
Trip/Fuel
Towing
Off Road
Settings

<b>Display Mode</b>
DTE
Dual Fuel Tanks
DEF Gauge
DEF Status
Exhaust Filter Status
Tire Pressure
Digital Speedometer



# Information Displays

Display Mode
Engine Information
Transmission Temp.

- DTE - Shows the approximate distance your vehicle can travel before running out of fuel.
- Dual Fuel Tanks - Shows the distance to empty for the front and rear tanks.
- DEF Gauge - Shows DEF gauge graphic.
- DEF Status - Shows DEF status on demand screen.
- Exhaust Filter - Shows exhaust filter on demand screen.
- Tire Pressure - Shows the tire pressure in psi.
- Digital Speedometer - Shows a digital display of your vehicle speed.
- Engine Information - Shows engine hours, engine idle hours and oil temperature.
- Transmission Temperature - Shows the transmission temperature value.

Trip/Fuel	
Trip 1	
Trip 2	
Fuel Economy	
Fuel History	
Compass	Select Your Setting
Average Speed	

Trip 1 or 2

- Shows the time, mileage and average fuel economy of an individual journey. Also shows DTE.

Fuel

- Fuel Economy - Shows your instantaneous fuel usage as a bar graph, average mpg and DTE.
- Fuel History - Shows your fuel usage based on time. The graph is updated each minute with the fuel economy that you achieved during 30 minutes of driving. Also shows DTE.

**Note:** Press and hold OK to reset values.

**Note:** Once you select a trailer, it remains active until you set it as no longer active. An active trailer still accumulates miles even after you physically disconnect it from your vehicle.

## Information Displays

<b>Towing</b>						
Trailer Status	Trailer Status	Provides trailer status information for the active trailer: Trailer Blind Spot status, Trailer Reverse Guidance status, trailer name, accumulated trailer miles, trailer brake gain and output.				
	Trailer Light Check	Provides status of the brake, park and direction indicator light for the active trailer.				
Trailer Tire Pressure	Displays the trailer tire pressure and options to customize the display.					
Trailer Options	Trailer Sway Control					
	Select Trailer					
	Change Trailer Settings	Rename Trailer	Follow onscreen directions to confirm or modify your settings.			
		Reset Trailer Distance				
		Change Blind Spot Measure				
		Add Trailer Blind Spot				
		Change Trailer Sticker				
		Add Trailer Rev. Guidance				
		Change Brake Type			Select Your Setting	
		Change Brake Effort				
		Delete Trailer				
	Change Trailer Setup	Select Your Setting				
	Add Trailer	Add Trailer				
		Trailer Brake Type	Select Your Setting			
Trailer Brake Effort						

# Information Displays

<b>Towing</b>			
		Change Trailer Setup	Follow onscreen directions to confirm or modify your settings.
		Trailer Rev. Guidance	
	Connection Checklist	Conventional	
		Fifth Wheel	
Gooseneck			

<b>Off Road</b>
Off Road Status

Displays pitch, steering angle and roll.

<b>Settings</b>			
Auto Regen			
Blind Spot			
Cross Traffic Alert			
DTE Calculation	Select Your Setting		
Rear Park Aid			
Trailer Blind Spot			
Advanced Settings	Vehicle	Auto Engine Off	
		Easy Entry/Exit	
	Lighting	Autolamp Delay	Select Your Setting
		Daytime Lights	
	Locks	Autolock	
		Autounlock	
		Remote Unlock	Select Your Setting

# Information Displays

Settings				
		Remote Start	Climate Control	
			Seats	
			Duration	
			System	
		Oil Life Reset	Follow onscreen directions to confirm or modify your settings.	
		Alarm	Select Your Setting	
			Ask on Exit	
		Windows	Remote Open	
			Remote Close	
		Wiper Controls	Courtesy Wipe	
	Rain Sensing			
	MyKey	MyKey Status		
		Create MyKey	Follow onscreen directions to confirm or modify your settings.	
		911 Assist	Select Your Setting	
Do Not Disturb				
AdvanceTrac				
Max Speed				
Speed Minder				
Volume Limiter				
Clear MyKeys		Follow onscreen directions to confirm or modify your settings.		
Display Setup	Units	Select Your Setting		
	Temperature			
	Tire Pressure			
	Language			

# Information Displays

## Information Display Controls (Type 3) (If Equipped)



- Press the up and down arrow buttons to scroll through and highlight the options within a menu.
- Press the right arrow button to enter a sub-menu.
- Press the left arrow button to exit a menu.
- Press the **OK** button to choose and confirm a setting or messages.



E219639

### Type 3

Main Menu
MyView
Trip/Fuel
Truck Info
Towing
Off Road
Settings

# Information Displays

<b>MyView</b>			
Trip 1			
Fuel Economy			
Tire Pressure			
Off Road Status			
Configure MyView	Add/Remove Screens	Trip/Fuel Screens	Trip 1
			Trip 2
			Fuel Economy
			Fuel History
			Average Speed
			Navigation/Compass
		Truck Info Screens	Turbo Boost
			Transmission Temp
			Trans. Temp. Gauge
			Diesel Particulate Filter
			Diesel Exhaust Fluid
			Gauge View
			Tire Pressure
			Digital Speedometer
			Engine Information
			MyKey Status
		Towing Screens	Towing Status
			Towing Information
			Trailer Light Check
		Off Road Screens	Off Road Status

## Information Displays

<b>MyView</b>			
	Reorder Screens	Screen Selection 1 - 7	Up/Down moves selection in the list
		Press OK to select	

- Trip 1/2 - Shows your trip timer, fuel used, trip odometer and average mpg.
- Fuel Economy - Shows your instantaneous fuel usage and average mpg.
- Tire Pressure - Shows your car outline with tire pressure values.
- Off Road Status - Shows your pitch and roll screen.

<b>Trip/Fuel</b>	
Trip 1	
Trip 2	
Fuel Economy	
Fuel History	
Navigation/Compass	
Compass	Select Your Setting

### Trip 1 or 2

- Trip Timer - Registers the time of individual journeys.
- DTE - Shows the approximate distance your vehicle can travel before running out of fuel.
- Odo - Registers the mileage of individual journeys.
- Avg mpg - Shows the average fuel economy for a given trip.

### Fuel

- Fuel Economy - Shows your instantaneous fuel usage as a bar graph and average mpg.
- Fuel History - Shows your fuel usage based on time. The graph is updated each minute with the fuel economy that you achieved during 30 minutes of driving.

### Navigation/Compass

- Navigation - Shows navigation turn by turn (Compass displayed when a route in Navigation is not set).

## Information Displays

---

Truck Info	
Turbo Boost Gauge	
Gauge View	Transmission Temperature Gauge
	Diesel Exhaust Fluid Gauge
Tire Pressure	
Digital Speedometer	
Diesel Exhaust Fluid Status	
Diesel Particulate Filter Status	
Dual Fuel Tanks	
Engine Information	
Transmission Temperature	

- Turbo Boost Gauge - Shows the turbo boost gauge.
- Transmission Temperature Gauge - Shows the transmission temperature gauge.
- Diesel Exhaust Fluid Gauge - Shows diesel exhaust fluid gauge.
- Tire Pressure - Shows the tire pressure in psi.
- Digital Speedometer - Shows a digital display of your vehicle speed.
- Diesel Exhaust Fluid Status - Shows the diesel exhaust fluid status.
- Diesel Particulate Filter Status - Shows the diesel particulate filter status.
- Dual Fuel Tanks - Shows the front and rear fuel tank gauges.
- Engine Information - Shows engine hours, engine idle hours and oil temperature.
- Transmission Temperature - Shows the transmission temperature value.

**Note:** Once you select a trailer, it remains active until you set it as no longer active. An active trailer still accumulates miles even after you physically disconnect it from your vehicle.



# Information Displays

<b>Towing</b>			
Towing Status	% Grade, steering angle, gain and output display		
Towing Information	Trailer Name, Accumulated Miles, Trailer Reverse Guidance Status, Trailer BLIS Status and Trailer Disconnected		
Trailer Light Check	Provides status of the brake, park and direction indicator light for the active trailer.		
Trailer Tire Pressure	Follow onscreen directions to confirm or modify your settings.		
Trailer Setup	Trailer Sway Control		
	Select trailer	Select Your Trailer	
	Change Trailer Settings	Rename Trailer	Follow onscreen directions to confirm or modify your settings.
		Reset Trailer Distance	
		Change Blind Spot Measurement	
		Add Blind Spot	
		Change Reverse Guidance Sticker	
		Add Trailer Reverse Guidance™	
		Change Brake Type	
		Change Brake Effort	
		Delete Trailer	
		Change Trailer Setup	
	Add Trailer	Trailer Brake Type	Select Your Setting
		Trailer Brake Effort	
Trailer Setup		Follow onscreen directions to confirm or modify your settings.	

# Information Displays

<b>Towing</b>		
Con- tion Check- list	Conventional	Follow onscreen directions to confirm or modify your settings.
	Fifth Wheel	
	Gooseneck	

<b>Off Road</b>
Off Road Status

Displays pitch, steering angle, roll, Elocker and 4X4.

<b>Settings</b>		
Auto Highbeam		
Auto Regen		
Blind Spot		
Cross Traffic Alert		
Driver Alert		
Rear Park Aid		
Trailer Blind Spot		
Pre-Collision	Alert Sensitivity	Select Your Setting
	Pre-Collision - On	
Cruise Control	Select Your Setting	
DTE Calculation		
Gauge Selection		
Lane Keeping System	Mode	Select Your Setting
	Sensitivity	
	Alert Intensity	

# Information Displays

Settings				
Advanced Settings	Vehicle	Auto Engine Off		
		Easy Entry/Exit		
		Lighting	Autolamp Delay	Select Your Setting
			Daytime Lights	
		Locks	Autolock	
			Autounlock	
			Remote Unlock	Select Your Setting
		Oil Life Reset	Follow onscreen directions to confirm or modify your settings.	
		Alarm	Select Your Setting	
			Ask on Exit	
		Power Running Boards	Select Your Setting	
		Remote Start	Climate Control	Select Your Setting
			Front Seats & Wheel	
	Duration			
	System			
	Windows	Remote Open		
	Wiper Controls	Courtesy Wipe		
Rain Sensing				
MyKey	MyKey Status	Shows information related to the configured MyKey(s)		
	Create MyKey	Follow onscreen directions to confirm or modify your settings.		
	911 Assist	Select Your Setting		
	Do Not Disturb			
	AdvanceTrac			

# Information Displays

Settings			
		Max Speed	
		Speed Minder	
		Volume Limiter	
		Clear MyKeys	
	Display Setup	Units	Select Your Setting
Temperature			
Tire Pressure			
Language			

## INFORMATION MESSAGES

**Note:** Depending on your vehicle options and instrument cluster type, not all of the messages will display or be available. The information display may abbreviate or shorten certain messages.



E184451

Press the **OK** button to acknowledge and remove some messages from the information display. The information display will automatically remove other messages after a short time.

You need to confirm certain messages before you can access the menus.

## Active Park

Message	Action
Active Park Fault	The system requires service due to a malfunction. Have the system checked by an authorized dealer.

# Information Displays

## Adaptive Cruise Control

Message	Action
Adaptive Cruise Malfunction	A radar malfunction is preventing the adaptive cruise control from engaging. See <b>Using Cruise Control</b> (page 243).
Adaptive Cruise Not Available	A condition exists such that the adaptive cruise cannot function properly. See <b>Using Cruise Control</b> (page 243).
Adaptive Cruise Not Available Sensor Blocked See Manual	You have a blocked sensor due to bad weather, ice, mud or water in front of the radar sensor. You can typically clean the sensor to resolve. See <b>Using Cruise Control</b> (page 243).
Normal Cruise Active Adaptive Braking Off	The system has disabled the automatic braking.
Front Sensor Not Aligned	A radar malfunction is preventing the adaptive cruise control from engaging.
Adaptive Cruise - Driver Resume Control	The adaptive cruise has reinstated controls to the driver.
Adaptive Cruise Speed Too Low to Activate	Your vehicle speed is too slow to activate the adaptive cruise.
Adaptive Cruise Shift Down	The adaptive cruise is automatically adjusting the gap distance and you need to shift the transmission into a lower gear.

## Adaptive Steering

Message	Action
Adaptive Steering Initialization	The adaptive steering system has detected a difference between steering wheel angle and the desired road wheel angle. The steering wheel adjusts itself to correct this difference. This adjustment is part of normal system operation.
Adaptive Steering Fault Service Required	The adaptive steering system is off. It is possible that the steering wheel may not be straight when the vehicle is driving straight ahead. If this message persists, see an authorized dealer.
Adaptive Steering Loss Do Not Drive	The adaptive steering system integrity cannot be verified. Do not drive the vehicle and contact an authorized dealer immediately.

# Information Displays

## AdvanceTrac and Traction Control

Message	Action
Service AdvanceTrac	The system detects a condition that requires service. Contact an authorized dealer as soon as possible.
AdvanceTrac Off	The status of the AdvanceTrac system after you switched it off.
AdvanceTrac On	The status of the AdvanceTrac system after you switched it on.
AdvanceTrac SPORT MODE	The status of the AdvanceTrac sport mode after you switched it on.
Traction Control Off	The status of the traction control system after you switched it off. See <b>Using Traction Control</b> (page 229).
Traction Control On	The status of the traction control system after you switched it on. See <b>Using Traction Control</b> (page 229).

## Airbag

Message	Action
Occupant Sensor BLOCKED Remove Objects Near Passenger Seat	Displays when the system detects a malfunction due to a blocked sensor.

## Alarm and Security

Message	Action
Vehicle Alarm To Stop Alarm, Start Vehicle.	Alarm triggered due to unauthorized entry. See <b>Anti-Theft Alarm</b> (page 78).

# Information Displays

## Automatic Engine Shutdown

Message	Action
Engine Shuts Off In {seconds to shut off:#0} Seconds	The engine is getting ready to shut off.
Engine Shut Off For Fuel Economy	The engine has shut off to help increase fuel economy.
Engine Shuts Off in {seconds to shut off:#0} Seconds Press Ok to Override	The engine is getting ready to shut off. You can press <b>OK</b> on the left steering wheel button to override the shut down.

## Battery and Charging System

Message	Action
Check Charging System	The charging system needs servicing. If the warning stays on or continues to come on, contact an authorized dealer as soon as possible.
Low Battery Features Temporarily Turned Off	The battery management system detects an extended low-voltage condition. Your vehicle will disable various features to help preserve the battery. Turn off as many of the electrical loads as soon as possible to improve system voltage. If the system voltage has recovered, the disabled features will operate again as normal.
Turn Power Off To Save Battery	The battery management system determines that the battery is at a low state of charge. Turn your ignition off as soon as possible to protect the battery. This message will clear once you restart your vehicle and the battery state of charge has recovered. Turning off unnecessary electrical loads will allow faster battery state-of-charge recovery.

# Information Displays

## Blind Spot Information and Cross Traffic Alert System

Message	Action
Blindspot System Fault	A fault with the system has occurred. Contact an authorized dealer as soon as possible.
Blindspot Not Available Sensor Blocked See Manual	The system sensors are blocked. See <b>Blind Spot Information System</b> (page 252).
Vehicle Coming From X	The system detects a vehicle. See <b>Blind Spot Information System</b> (page 252).
Cross Traffic Not Available Sensor Blocked See Manual	The blind spot information system and cross traffic alert system sensors are blocked. See <b>Blind Spot Information System</b> (page 252).
Cross Traffic System Fault	A fault with the system has occurred. Contact an authorized dealer as soon as possible.
Cross Traffic Alert Deactivated Trailer Attached	The system automatically turns off and displays this message when you connect a trailer to the vehicle that does not have a trailer blind spot system or when you switch the trailer blind spot system off through the information display. See <b>Blind Spot Information System</b> (page 252).
Blind Spot Alert Deactivated Trailer Attached	The system automatically turns off and displays this message when you connect a trailer to the vehicle that does not have a trailer blind spot system or when you switch the trailer blind spot system off through the information display. See <b>Blind Spot Information System</b> (page 252).
Trailer Blind Spot Not available Due to Invalid Trailer	Displays when the trailer connected is a fifth wheel or goose-neck, or when the trailer width is wider than 10 ft (2.7 m) or longer than 33 ft (10 m).



# Information Displays

## Collision Warning System

Message	Action
Collision Warning Malfunction	A fault with the system has occurred. Contact an authorized dealer as soon as possible.
Collision Warning Not Available Sensor Blocked See Manual	You have a blocked sensor due to bad weather, ice, mud or water in front of the radar sensor. You can typically clean the sensor to resolve. See <b>Driving Aids</b> (page 250).
Collision Warning Not Available	A fault with the system has occurred. Contact an authorized dealer as soon as possible.

## Diesel Messages

### WARNING



When the **Exhaust Filter Cleaning** message appears in the information display, do not park near flammable materials, vapors or structures until filter cleaning is complete.

Message	Action
Exhaust Filter Cleaning	Your vehicle has entered the cleaning mode. Various engine actions will raise the exhaust temperature in the Diesel Particulate Filter system to burn off the particles (exhaust soot). After the vehicle burns the particles off, the exhaust temperature will return to normal levels. This message is NORMAL.
Exhaust Filter Overloaded Drive to Clean	The diesel particulate filter is full of particles (exhaust soot) and you are not operating the vehicle in a manner that allows normal cleaning. Drive the vehicle above 30 mph (48 km/h) until the <b>Exhaust Filter Cleaning</b> message turns off.
Exhaust Filter Overloaded Clean Now	
Exhaust Filter at Limit Clean Now	The diesel particulate filter is full of particles (exhaust soot) and you are not operating the vehicle in a manner that allows normal cleaning. Drive the vehicle above 30 mph (48 km/h) until the <b>Exhaust Filter Cleaning</b> message turns off.
Exhaust Filter at Limit Drive to Clean Now	

## Information Displays

Message	Action
Exhaust System Overheated Stop Safely NOW	Your vehicle exhaust system temperature exceeded the intended operating range. If this warning occurs, a tone sounds, followed by reduced engine power. The engine shuts down when your vehicle speed is below 3 mph (5 km/h) . Stop the vehicle as soon as safely possible. Have the system checked by an authorized dealer.
Engine Warming Please Wait {seconds:00} sec	In extremely cold weather, typically below -15°F (-26°C) and if the engine block heater is not utilized, your engine will not respond to accelerator pedal movement for 30 seconds. This restriction allows your engine to circulate the oil properly in order to avoid engine damage.
Exhaust Filter Drive Complete	Your diesel particulate filter is clean.
Exhaust Filter Cleaned	Your diesel particulate filter is clean (OCR Only).
Exhaust Filter Cleaning Stopped	The manual regeneration process has stopped (OCR Only).
DEF Level Range: XX mi/ km Refill Now	The distance you can travel before depleting the remaining diesel exhaust fluid.
DEF Level Empty Speed Limited to XX MPH / km/ h in XX mi/km	Your diesel exhaust fluid is nearing empty. Your vehicle's top speed will become limited in the displayed distance. You must replenish the diesel exhaust fluid to resume normal operation of your vehicle. See <b>Selective Catalytic Reductant System</b> (page 198).
DEF Level Empty Speed Limited to XX MPH/km/ h Upon Restart	Your remaining diesel exhaust fluid has depleted. Your speed will be limited upon restart. You must replenish the diesel exhaust fluid to resume normal operation of your vehicle. See <b>Selective Catalytic Reductant System</b> (page 198).
DEF Level Empty Speed Limited to XX MPH/km/ h	The diesel exhaust fluid is empty. You must replenish the diesel exhaust fluid to resume normal operation of your vehicle. See <b>Selective Catalytic Reductant System</b> (page 198).
DEF Level Empty Engine Idled Soon	The selective catalytic reduction system detects low exhaust fluid. The engine will eventually enter into an idle only mode. You must replenish the diesel exhaust fluid to resume normal operation of your vehicle. See <b>Selective Catalytic Reductant System</b> (page 198).

## Information Displays

Message	Action
DEF Level Empty Engine Idled See Manual	A problem exists with the selective catalytic reduction system. The vehicle will enter into an idle-only mode. If the exhaust fluid is empty, you must replenish the diesel exhaust fluid to resume normal operation of your vehicle. See <b>Selective Catalytic Reductant System</b> (page 198).
DEF Fault Speed Limited to XX MPH/km/h in XX mi/km	The selective catalytic reduction system detects a fault. The vehicle's top speed will become limited in the displayed distance and count down from this point. Have the system checked by an authorized dealer.
DEF Fault Speed Limited to XX MPH/km/h Upon Restart	The selective catalytic reduction system detects a fault. The vehicle's top speed will become limited upon restarting. Have the system checked by an authorized dealer.
DEF Fault Speed Limited to XX MPH/km/h	The selective catalytic reduction system detects a fault. The vehicle's top speed is limited. Have the system checked by an authorized dealer.
Exhaust Filter Over Limit Service Now	You must have your vehicle serviced by an authorized dealer. Ignoring the <b>Exhaust Filter Over Limit Service Now</b> warning message could lead to reduced drivability and customer expense, including damage to the diesel particulate filter. Your new vehicle warranty may not cover this damage.
Water in Fuel Drain Filter	The water separator has reached a predetermined capacity and needs draining. See <b>Draining the Fuel Filter Water Trap</b> (page 351).
Fuel Pressure Low	A low fuel pressure condition has occurred due to cold, low fuel level or fuel filters need to be changed. See <b>Fuel Quality</b> (page 187).

## Doors and Locks

Message	Action
X Door Ajar	The door(s) listed is not completely closed.

# Information Displays

## Driver Alert

Message	Action
Driver Alert Warning Rest Now	Stop and rest as soon as it is safe to do so.
Driver Alert Warning Rest Suggested	Take a rest soon.

## Drivetrain

Message	Action
To Engage Locking Differential Slow to XX mph/km/h	The electronic locking differential requests a certain speed requirement to engage.
To Engage Locking Differential Release Accelerator Pedal	The electronic locking differential requests the accelerator to be released in order to engage.
Check Locking Differential	An electronic locking differential (ELD) system fault is present. Contact an authorized dealer as soon as possible.
Neutral Tow Enabled Leave Transmission in Neutral	The transfer case is in the neutral position. This message indicates that your vehicle is safe to be towed with all four wheels on the ground.
Neutral Tow Disabled	The transfer case is NOT in the neutral position. This message indicates that your vehicle is NOT safe to be towed with all four wheels on the ground.

## Engine

Message	Action
Power Reduced to Lower Engine Temp	The engine has reduced power to help reduce high engine temperature.

# Information Displays

## Fuel

Message	Action
Fuel Level Low	An early reminder of a low fuel condition.
Check Fuel Fill Inlet	The fuel fill inlet may not be properly closed.

## Keys and Intelligent Access

Message	Action
To START Press Brake	A reminder to press the brake while starting the vehicle.
No Key Detected	The system does not detect a key in your vehicle. See <b>Keyless Starting</b> (page 176).
Restart Now or Key is Needed	You pressed the StartStop button to switch off the engine and your vehicle does not detect your intelligent access key inside your vehicle.
Full Accessory Power Active	Your vehicle is in the run ignition state.
Starting System Fault	There is a problem with your vehicle's starting system. See an authorized dealer for service.
Key Program Successful	You have successfully programmed an intelligent access key to the system.
Key Program Failure	You have failed to program an intelligent access key to the system.
Max Number of Keys Learned	You have programmed the maximum number of keys to the system.
Not Enough Keys Learned	You have not programmed enough keys to the system.
Engine ON	Informs you that you are exiting your vehicle and the engine is on.

# Information Displays

## Lane Keeping System

Message	Action
Lane Keeping Sys. Malfunction Service Required	The system has malfunctioned. Contact an authorized dealer as soon as possible.
Front Camera Temporarily Not Available	The system has detected a condition that has caused the system to be temporarily unavailable.
Front Camera Low Visibility Clean Screen	The system has detected a condition that requires you to clean the windshield in order for it to operate properly.
Front Camera Malfunction Service Required	The system has malfunctioned. Contact an authorized dealer as soon as possible.
Keep Hands on Steering Wheel	The system requests you to keep your hands on the steering wheel.

## Maintenance

Message	Action
Low Engine Oil Pressure	Stop your vehicle as soon as safely possible and turn off the engine. Check the oil level. If the warning stays on or continues to come on with your engine running, contact an authorized dealer as soon as possible.
Change Engine Oil Soon	The engine oil life remaining is 10% or less. See <b>Changing the Engine Oil and Oil Filter</b> (page 335).
Oil Change Required	The oil life left is at 0%. See <b>Changing the Engine Oil and Oil Filter</b> (page 335).
Brake Fluid Level Low	The brake fluid level is low, inspected the brake system immediately. See <b>Brake Fluid Check</b> (page 349).
Check Brake System	The brake system needs servicing. Stop your vehicle in a safe place. Contact an authorized dealer.
Transport / Factory Mode Contact Dealer	Your vehicle is still in Transport or Factory mode. This may not allow some features to operate properly. See an authorized dealer.
See Manual	The powertrain needs service due to a powertrain malfunction.

## Information Displays

### MyKey

Message	Action
MyKey not Created	You did not program a MyKey.
MyKey Active Drive Safely	MyKey is active.
Speed Limited to XX MPH/km/h	When switching on your vehicle and MyKey is in use, displays that the MyKey speed limit is on.
Near Vehicle Top Speed	MyKey is in use and the MyKey speed limit is on and the vehicle speed is approaching 81 mph (130 km/h).
Vehicle at Top Speed of MyKey Setting	You have reached the speed limit set for your MyKey.
Check Speed Drive Safely	You have an active MyKey with a programmed set speed limit.
Buckle Up to Unmute Audio	Belt-Minder turns on with a MyKey in use.
AdvanceTrac On - MyKey Setting	With a MyKey in use, AdvanceTrac turns on.
Traction Control On - MyKey Setting	With a MyKey in use, traction control turns on.
MyKey Park Aid Cannot be Deactivated	With a MyKey in use, park aid is always on.
Lane Keeping Alert On MyKey Setting	With a MyKey in use, lane keeping alert turns on.

### Off Road

Message	Action
Hill Descent Control Active	Hill descent control mode is active.
Hill Descent Control OFF	Hill descent control mode is inactive.
For Hill Descent Reduce Speed XX MPH/km/h or Less	Your vehicle speed requirement for off-road mode entry has not been met.
For Hill Descent Select Gear	You need to select a transmission gear for hill descent mode.

## Information Displays

Message	Action
Hill Descent Driver Resume Control	Hill descent control mode is deactivated and you must resume control.
Hill Descent Control Fault	A hill descent system fault is present.
Hill Descent Control Off System Cooling	The hill descent system is cooling due to overuse.
Hill Descent Control Ready	The hill descent control system is ready.

### Park Aid

Message	Action
Check Front Park Aid	The system has detected a condition that requires service. Contact an authorized dealer. See <b>Rear Parking Aid</b> (page 235).
Check Rear Park Aid	The system has detected a condition that requires service. Contact an authorized dealer. See <b>Rear Parking Aid</b> (page 235).
Front Park Aid On Off	Displays the park aid status.
Rear Park Aid On Off	Displays the park aid status.

### Park Brake

Message	Action
To Release: Press Brake and Switch	The electric parking brake is set and a manual release is attempted without the brake pedal being pressed.
Park Brake Use Switch to Release	The electric park brake is set and an automatic release is attempted but cannot be performed. Perform a manual release.
Release Park Brake	The electric park brake is set and your vehicle speed exceeds 3 mph (5 km/h). Release park brake before continued driving.
Park Brake Not Applied	The electric park brake is not fully applied.
Park Brake Not Released	The electric park brake is not fully released.



## Information Displays

Message	Action
Park Brake Maintenance Mode	The electric park brake system has been put into a special mode that is used to allow service of the rear brakes. Contact an authorized dealer.
Park Brake Limited Function Service Required	The electric park brake system has detected a condition that requires service. Some functionality may still be available. Contact an authorized dealer.
Park Brake Malfunction Service Now	The electric park brake system has detected a condition that requires service. Contact an authorized dealer.

### Power Steering

Message	Action
Steering Fault Service Now	The power steering system has detected a condition that requires service. See an authorized dealer.
Steering Loss Stop Safely	The power steering system is not working. Stop your vehicle in a safe place. Contact an authorized dealer.
Steering Assist Fault Service Required	The power steering system has detected a condition within the power steering system or passive entry or passive start system requires service. Contact an authorized dealer.
Steering Lock Malfunction Service Now	The steering lock system has detected a condition that requires service. See an authorized dealer.

### Remote Start

Message	Action
To Drive: Press Brake and Gear Shift Button	A reminder to apply the brake and push the gearshift button to drive your vehicle after a remote start.

### Seats

Message	Action
Memory Recall Not Permitted While Driving	A reminder that memory seats are not available while driving.
Memory {0} Saved	Shows where you have saved your memory setting.

# Information Displays

## Starting System

Message	Action
To START Press Brake	A reminder to apply the brake when starting your vehicle .
Cranking Time Exceeded	The starter has exceeded its cranking time in attempting to start your vehicle.
Engine Start Pending Please Wait	The starter is attempting to start your vehicle.
Pending Start Cancelled	The system has cancelled the pending start.

## Tire Pressure Monitoring System

Message	Action
Tire Pressure Low	One or more tires on your vehicle has low tire pressure. See <b>Tire Pressure Monitoring System</b> (page 400).
Tire Pressure Monitor Fault	The tire pressure monitoring system is malfunctioning. If the warning stays on or continues to come on, contact an authorized dealer. See <b>Tire Pressure Monitoring System</b> (page 400).
Tire Pressure Sensor Fault	A tire pressure sensor is malfunctioning or your spare tire is in use. See <b>Tire Pressure Monitoring System</b> (page 400). If the warning stays on or continues to come on, contact an authorized dealer as soon as possible.

## Trailer

Message	Action
Trailer Brake Gain: {trailer gain value:#0.0}	The current gain setting for the trailer brake.
Trailer Brake Gain: {trailer gain value:#0.0} No Trailer	The current gain setting for the trailer brake when a trailer is not connected.
Trailer Brake Module Fault	Faults sensed in the Integrated Trailer Brake Control Module followed by a single chime. See <b>Towing a Trailer</b> (page 272).
Trailer Connected	A correct trailer connection is sensed during a given ignition cycle.

## Information Displays

Message	Action
Trailer Disconnected	A trailer connection becomes disconnected, either intentionally or unintentionally, and has been sensed during a given ignition cycle.
Trailer Sway Reduce Speed	The trailer sway control has detected trailer sway.
Trailer Wiring Fault	There are certain faults in your vehicle wiring and trailer wiring/brake system. See <b>Towing a Trailer</b> (page 272).
Trailer Left Turn Lamps Fault Check Lamps	There is a fault with your trailer turn lamp. Check your lamp.
Trailer Right Turn Lamps Fault Check Lamps	There is a fault with your trailer turn lamp. Check your lamp.
Trailer Battery Not Charging See Manual	There is a fault with your trailer battery. See <b>Towing a Trailer</b> (page 272).
Trailer Lighting Module Fault See Manual	There is a fault with your vehicle trailer lighting module. See <b>Towing a Trailer</b> (page 272).
Trailer Tire Low Specified:	One or more tires on your trailer is below the specified tire pressure.
Trailer Tire Pressure Sensor Fault	A trailer tire pressure sensor is malfunctioning. If the warning stays on or continues to come on, contact an authorized dealer as soon as possible.
Trailer Tire Pressure Monitor Fault	The trailer tire pressure monitoring system is malfunctioning. If the warning stays on or continues to come on, contact an authorized dealer.
Trailer Tire Pressure Monitor Capability Not Detected	The system cannot detect the trailer tire pressure monitoring system.
Trailer Tire Pressure Indication Not Setup See Manual	The trailer tire pressure monitoring system is not setup. See <b>General Information</b> (page 113).

# Information Displays

## 4WD

<b>Message</b>	<b>Action</b>
Check 4x4	A 4X4 system fault is present. Contact an authorized dealer as soon as possible.
4x4 Shift in Progress	The 4X4 system is making a shift.
For 4x4 LOW Shift to N	When your vehicle is at a stop and you need to shift into Neutral before you select 4X4 LOW.
For 4x4 LOW Slow to 3 MPH	When your vehicle is moving and you need to reduce your speed to select 4X4 LOW.
To Exit 4x4 LOW Shift to N	You select 2WD while your vehicle is at a stop in 4X4 LOW and you need to shift into Neutral.
To Exit 4x4 LOW Slow to 3 MPH	You select 2WD while your vehicle is operating in 4X4 LOW and you need to reduce your speed.
Shift Delayed Pull Forward	May display when there is a Transfer case gear tooth blockage while shifting to or from 4L or to the neutral state.
4x4 Temporarily Disabled	The 4X4 system is temporarily disabled, and the overall powertrain output response is reduced. The 4X4 system and powertrain response will be automatically restored after the 4X4 system has had the opportunity to cool down.
4x4 Restored	The 4X4 system has been restored to its original setting.
4x4 Temporarily Locked	The 4X4 system is temporarily locked for added drive-line protection and has automatically switched to 4H setting.

# Climate Control

## MANUAL CLIMATE CONTROL (If Equipped)

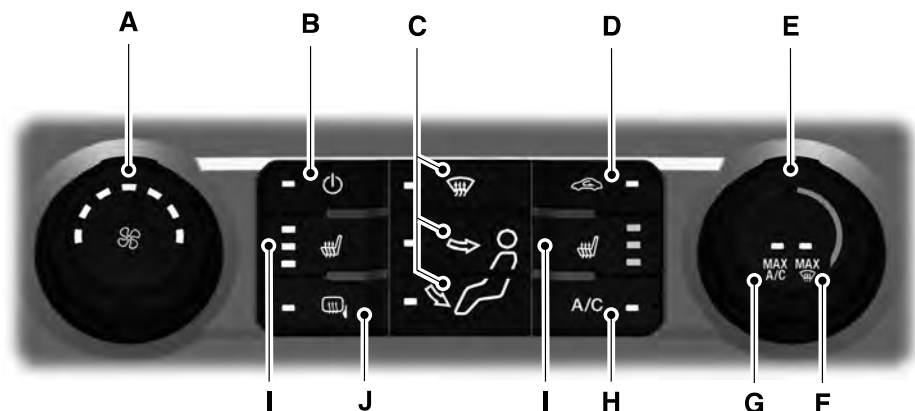

E217902

- A **Fan speed control:** Adjusts the volume of air circulated in the vehicle.
- B **Power:** Press to switch the system on and off. When the system is off, it prevents outside air from entering the vehicle.
- C **Air distribution control:** Press to switch air flow from the windshield, instrument panel, or footwell vents on or off. You can distribute air through any combination of these vents.
- Note:** At least one of these buttons remain on while the system is on.

- D **Recirculated air:** Press to switch between outside air and recirculated air. The air currently in the passenger compartment recirculates. This may reduce the time needed to cool the interior (when used with A/C) and reduce unwanted odors from entering your vehicle.
- Note:** Recirculated air may turn off (or prevent you from switching on) in all air flow modes except MAX A/C to reduce the risk of fogging. Recirculation may also turn on and off in Panel or Panel/Floor air flow modes during hot weather in order to improve cooling efficiency.

# Climate Control

---

- E Temperature control:** Adjusts the temperature of the air circulated in your vehicle.
- F MAX Defrost:** Turn to the right to switch on defrost. Air flows through the windshield vents and the fan adjusts to the highest speed. You can also use this setting to defog and clear the windshield of a thin covering of ice. The heated rear window also turns on when you select maximum defrost.
- Note:** To prevent window fogging, you cannot select recirculated air when maximum defrost is on.
- G MAX A/C:** Turn to the left for maximum cooling. Recirculated air flows through the instrument panel vents, air conditioning turns on and the fan adjusts to the highest speed.
- H A/C:** Press to switch the air conditioning on or off. Use A/C with recirculated air to improve cooling performance and efficiency.
- Note:** In certain conditions (for example, maximum defrost), the air conditioning compressor may continue to operate even though you switch off the air conditioning.
- I Heated seats:** Press to switch the heated seats on and off. See **Heated Seats** (page 162).
- J Heated exterior mirrors:** Press to switch the heated exterior mirrors on and off.

## **AUTOMATIC CLIMATE CONTROL (If Equipped)**

# Climate Control

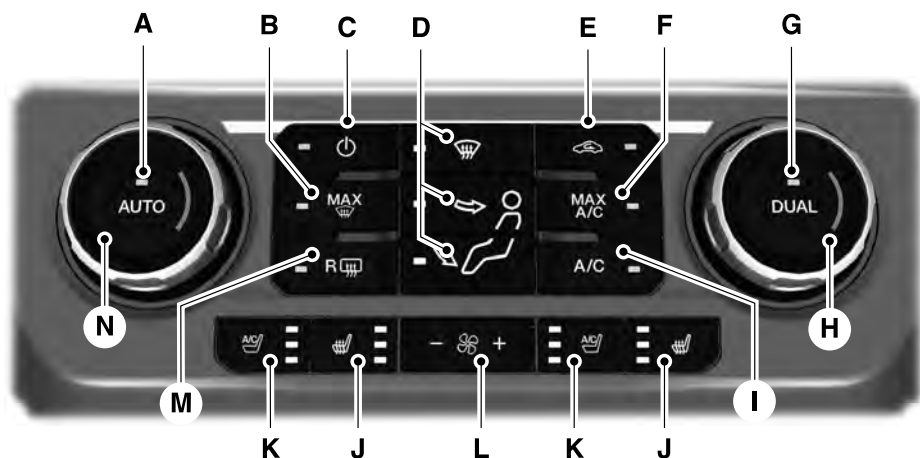

E217905

**A AUTO:** Press to switch on automatic operation. Adjust to select the desired temperature. Fan speed, air distribution, air conditioning operation, and outside or recirculated air adjust to heat or cool the vehicle to maintain the desired temperature. You can also switch off dual zone mode by pressing and holding for more than two seconds.

**B MAX Defrost:** Press to switch on defrost. The driver and passenger settings set to HI, air flows through the windshield vents, and the fan adjusts to the highest speed. You can also use this setting to defog and clear the windshield of a thin covering of ice. The heated rear window also turns on when you select maximum defrost.

**Note:** To prevent window fogging, you cannot select recirculated air when maximum defrost is on.

**C Power:** Press to switch the system on and off. When the system is off, it prevents outside air from entering the vehicle.

**D Air distribution control:** Press to switch air flow from the windshield, instrument panel or footwell vents on or off. You can distribute air through any combination of these vents.

**E Recirculated air:** Press to switch between outside air and recirculated air. The air currently in the passenger compartment recirculates. This may reduce the time needed to cool the interior (when used with A/C) and reduce unwanted odors from entering your vehicle.

# Climate Control

- Note:** Recirculated air may turn off (or prevent you from switching on) in all air flow modes except MAX A/C to reduce the risk of fogging. Recirculation may also turn on and off in Panel or Panel/Floor air flow modes during hot weather in order to improve cooling efficiency.
- F** **MAX A/C:** Press for maximum cooling. The driver and passenger settings set to LO, recirculated air flows through the instrument panel vents, air conditioning turns on and the fan adjusts to the highest speed.
- G** **DUAL:** Press to switch on temperature control for the passenger side of the vehicle. When dual zone is off, passenger temperature settings remain the same as the driver settings.
- H** **Passenger temperature control:** Adjusts the temperature setting on the passenger side.
- I** **A/C:** Press to switch the air conditioning on or off. Use A/C with recirculated air to improve cooling performance and efficiency.
- Note:** In certain conditions (for example, maximum defrost), the air conditioning compressor may continue to operate even though you switch off the air conditioning.
- J** **Heated seats:** Press to switch the heated seats on and off. See **Heated Seats** (page 162).
- K** **Climate controlled seats:** Press to switch the climate controlled seats on and off. See **Climate Controlled Seats** (page 163).
- L** **Fan speed control:** Adjusts the volume of air circulated in the vehicle.
- M** **Heated rear window:** Press to switch the heated rear window on and off. See **Heated Rear Window** (page 152).
- N** **Driver temperature control:** Adjusts the temperature setting on the driver side. This control also adjusts the passenger side temperature when you switch off dual zone mode.

## HINTS ON CONTROLLING THE INTERIOR CLIMATE

### General Hints

**Note:** *Prolonged use of recirculated air may cause the windows to fog up.*

**Note:** *You may feel a small amount of air from the footwell air vents regardless of the air distribution setting.*

**Note:** *To reduce humidity build-up inside your vehicle, do not drive with the system switched off or with recirculated air always switched on.*

**Note:** *Do not place objects under the front seats as this may interfere with the airflow to the rear seats.*

**Note:** *Remove any snow, ice or leaves from the air intake area at the base of the windshield.*

**Note:** *To improve the time to reach a comfortable temperature in hot weather, drive with the windows open until you feel cold air through the air vents.*



# Climate Control

## Manual Climate Control

**Note:** To reduce fogging of the windshield during humid weather, adjust the air distribution control to the windshield air vents position.

## Automatic Climate Control

**Note:** Adjusting the settings when your vehicle interior is extremely hot or cold is not necessary. The system automatically adjusts to heat or cool the interior to your selected temperature as quickly as possible. For the system to function efficiently, the instrument panel and side air vents should be fully open.

**Note:** If you select **AUTO** during cold temperatures, the system directs airflow to the windshield and side window vents. In addition, the fan may run at a slower speed until the engine warms up.

**Note:** If you select **AUTO** during hot temperatures and the inside of the vehicle is hot, the system automatically uses recirculated air to maximize interior cooling. Fan speed may also reduce until the air cools.

## Quickly Heating the Interior

	Manual climate control	Automatic climate control
1	Adjust the fan speed to the highest setting.	Press <b>AUTO</b> .
2	Adjust the temperature control to the full heat setting.	Adjust the temperature control to the desired setting.
3	Direct air to the footwell using the air distribution buttons.	

## Recommended Settings for Heating

	Manual climate control	Automatic climate control
1	Adjust the fan speed to the center setting.	Press <b>AUTO</b> .
2	Adjust the temperature control to the midway point of the hot settings.	Adjust the temperature control to the desired setting. Use 72°F (22°C) as a starting point, then adjust the setting as necessary.
3	Direct air to the footwell using the air distribution buttons.	

# Climate Control

## Quickly Cooling the Interior

	<b>Manual climate control</b>	<b>Automatic climate control</b>
1	Select <b>MAX A/C</b> .	Select <b>MAX A/C</b> .
2	Drive with the windows open until you feel cold air through the air vents.	

## Recommended Settings for Cooling

	<b>Manual climate control</b>	<b>Automatic climate control</b>
1	Adjust the fan speed to the center setting.	Press <b>AUTO</b> .
2	Adjust the temperature control to the midway point of the cold settings.	Adjust the temperature control to the desired setting. Use 72°F (22°C) as a starting point, then adjust the setting as necessary.
3	Direct air to the instrument panel using the air distribution buttons.	

## Defogging the Side Windows in Cold Weather

	<b>Manual climate control</b>	<b>Automatic climate control</b>
1	Direct air to the windshield using the air distribution buttons.	Press the defrost button.
2	Press <b>A/C</b> .	Adjust the temperature control to the desired setting. Use 72°F (22°C) as a starting point, then adjust the setting as necessary.
3	Adjust the temperature control to the desired setting.	
4	Adjust the fan speed to the highest setting.	

# Climate Control

## HEATED REAR WINDOW (If

Equipped)



Press the button to clear the rear window of thin ice and fog. The heated rear window turns off after a short period of time.

**Note:** Make sure the engine is on before operating the heated windows.

**Note:** Do not use razor blades or other sharp objects to clean or remove decals from the inside of the heated rear window. The vehicle Warranty may not cover damage caused to the heated rear window grid lines.

## HEATED EXTERIOR MIRRORS

When you switch the heated rear window on, the heated exterior mirrors turn on.

**Note:** Do not remove ice from the mirrors with a scraper or adjust the mirror glass when it is frozen in place.

**Note:** Do not clean the mirror housing or glass with harsh abrasives, fuel or other petroleum-based cleaning products.

## CABIN AIR FILTER

Your vehicle is equipped with a cabin air filter, which gives you and your passengers the following benefits:

- It improves your driving comfort by reducing particle concentration.
- It improves the interior compartment cleanliness.
- It protects the climate control components from particle deposits.

You can locate the cabin air filter behind the glove box.

**Note:** Make sure you have a cabin air filter installed at all times. This prevents foreign objects from entering the system. Running the system without a filter in place could result in degradation or damage to the system.

Replace the filter at regular intervals. See **Scheduled Maintenance** (page 581).

For additional cabin air filter information, or to replace the filter, see an authorized dealer.

## REMOTE START (If Equipped)

You can switch this feature on or off and adjust the settings using the information display.

The system adjusts the interior temperature depending on your chosen settings during remote start.

You cannot adjust the climate control setting during remote start operation. When you switch the ignition on, the climate control system returns to the previous settings. You can now make adjustments.

You need to switch on certain vehicle-dependent features, such as:

- Heated seats.
- Cooled seats.
- Heated steering wheel.
- Heated mirrors.
- Heated rear window.

## Automatic Settings

In hot weather, the system sets to 72°F (22°C). The cooled seats are set to high (if available, and **AUTO** is on in the information display).

# Climate Control

---

In moderate weather, the system either heats or cools (based on previous settings). The rear defroster, heated mirrors and heated or cooled seats do not turn on.

In cold weather, the system sets to 72°F (22°C). The heated seats are set to high (if available, and **AUTO** is on in the information display). The heated rear window and heated mirrors turn on.

# Seats

## SITTING IN THE CORRECT POSITION

### WARNINGS



Sitting improperly, out of position or with the seatback reclined too far can take weight off the seat cushion and affect the decision of the passenger sensing system, resulting in serious injury or death in the event of a crash. Always sit upright against your seat back, with your feet on the floor.



Do not recline the seatback as this can cause the occupant to slide under the safety belt, resulting in serious injury in the event of a crash.



Do not place objects higher than the seatback to reduce the risk of serious injury in the event of a crash or during heavy braking.

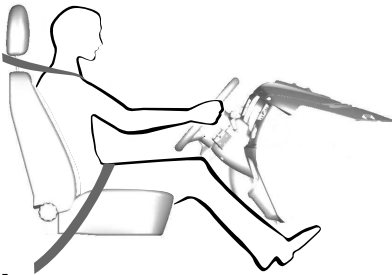

E68595

When you use them properly, the seat, head restraint, safety belt and airbags will provide optimum protection in the event of a crash.

We recommend that you follow these guidelines:

- Sit in an upright position with the base of your spine as far back as possible.
- Do not recline the seatback more than 30 degrees.
- Adjust the head restraint so that the top of it is level with the top of your head and as far forward as possible. Make sure that you remain comfortable.
- Keep sufficient distance between yourself and the steering wheel. We recommend a minimum of 10 in (25 cm) between your breastbone and the airbag cover.
- Hold the steering wheel with your arms slightly bent.
- Bend your legs slightly so that you can press the pedals fully.
- Position the shoulder strap of the safety belt over the center of your shoulder and position the lap strap tightly across your hips.

Make sure that your driving position is comfortable and that you can maintain full control of your vehicle.

## HEAD RESTRAINTS

### WARNINGS



Fully adjust the head restraint before you sit in or operate your vehicle. This will help minimize the risk of neck injury in the event of a crash. Do not adjust the head restraint when your vehicle is moving.



The head restraint is a safety device. Whenever possible it should be installed and properly adjusted when the seat is occupied. An improperly adjusted head restraint may not adequately protect an occupant during an impact from the rear.

# Seats

## WARNINGS



Install the head restraint properly to help minimize the risk of neck injury in the event of a crash.

**Note:** Adjust the seatback to an upright driving position before adjusting the head restraint. Adjust the head restraint so that the top of it is level with the top of your head and as far forward as possible. Make sure that you remain comfortable. If you are extremely tall, adjust the head restraint to its highest position.

### Front Seat Head Restraint

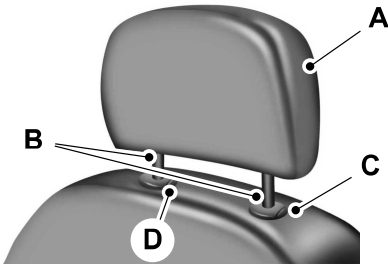

E138642

### Rear Seat Outboard Head Restraints

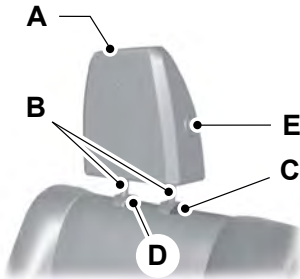

E166700

The head restraints may consist of:

- A An energy absorbing head restraint.
- B Two steel stems.
- C Guide sleeve adjust and release button.
- D Guide sleeve unlock and remove button.
- E Fold button.

## Adjusting the Head Restraint

### Raising the Head Restraint

Pull the head restraint up.

### Lowering the Head Restraint

1. Press and hold button C.
2. Push the head restraint down.

### Removing the Head Restraint

1. Press and hold buttons C and D.
2. Pull the head restraint up.

### Installing the Head Restraint

Align the steel stems into the guide sleeves and push the head restraint down until it locks.

### Folding the Head Restraint

**Note:** The rear seat outboard head restraints may fold forward for improved visibility.

1. Press and hold button E.
2. Pull it back up to reset.

### Front Row Center and Rear Seat Center (Crew Cab) Head Restraints

**Note:** The SuperCab has rear outboard head restraints that are not removable and are bolted to the back wall.

# Seats

Your vehicle may be equipped with head restraints that are non-adjustable. The non-adjustable head restraints consist of:

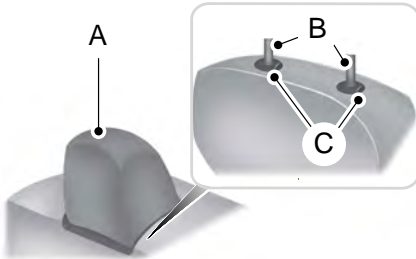

E162872

- A An energy absorbing head restraint.
- B Two steel stems.
- C Guide sleeve unlock and remove button.

## Removing the Head Restraint

1. Press and hold buttons C.
2. Pull up the head restraint.

## Installing the Head Restraint

Align the steel stems into the guide sleeves and push the head restraint down until it locks.

## Tilting Head Restraints (If Equipped)

The front head restraints tilt for extra comfort. To tilt the head restraint, do the following:



E144727

1. Adjust the seatback to an upright driving or riding position.
2. Pivot the head restraint forward toward your head to the desired position.

After the head restraint reaches the forward-most tilt position, pivot it forward again to release it to the rearward, un-tilted position.

**Note:** Do not attempt to force the head restraint backward after it is tilted. Instead, continue tilting it forward until the head restraint releases to the upright position.

## MANUAL SEATS (If Equipped)

### WARNING



Do not adjust the driver's seat or seatback when your vehicle is moving.

# Seats

## Moving the Seat Backward and Forward



E175314

## Recline Adjustment



E175315

## Manual Lumbar (If Equipped)



E166702

The lumbar support control is located on the outboard side of the seat. Turn the control to adjust your support.

## POWER SEATS (If Equipped)

### WARNINGS



Do not adjust the driver seat or seat backrest when your vehicle is moving. This may result in sudden seat movement, causing the loss of control of your vehicle.



Do not place cargo or any objects behind the seatback before returning it to the original position.



# Seats

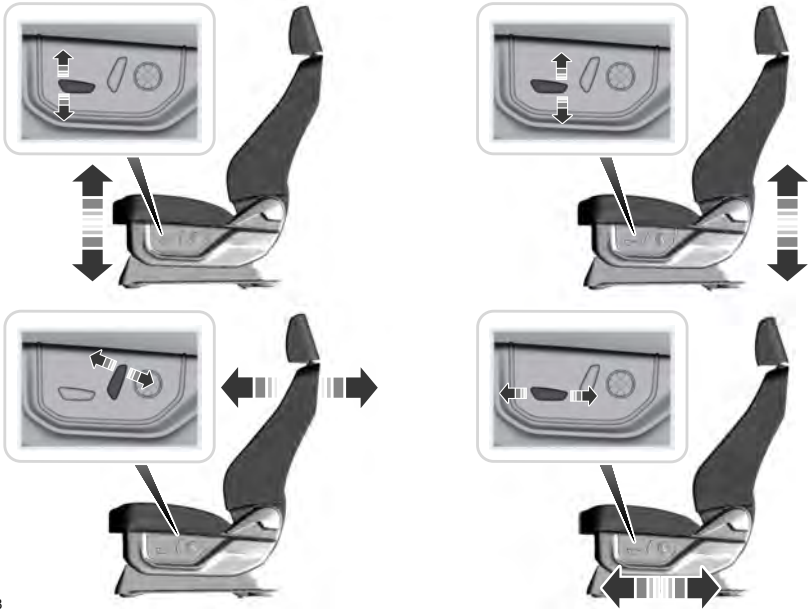

E176038

## Power Lumbar (If Equipped)

**Note:** The engine must be running or the vehicle must be in accessory mode to activate the seats.



E176039

## Multi-Contour Front Seats With Active Motion (If Equipped)

**Note:** The massage system turns off after 20 minutes.

**Note:** Allow a few seconds for any selection to activate. When the seatback and cushion are both active, the massage will alternate between zones

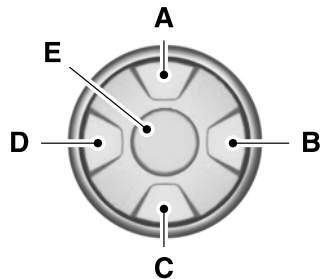

E156301

# Seats

	<b>Massage mode</b>	<b>Lumbar and bolster mode</b>
A	Back massage intensity adjustment	Upper lumbar
B	Massage intensity decrease and off*	Lumbar decrease
C	Cushion massage intensity adjustment	Lower lumbar**
D	Massage intensity increase	Lumbar increase
E	On and off	-

\*The massage feature defaults to an alternating massage mode with back massage intensity adjustment. The lumbar and bolster feature defaults to the middle lumbar mode.

\*\*Press C a second time to adjust the back bolster. Press C a third time to adjust the cushion bolster.

You can also adjust this feature through the touchscreen. When switched on, the system displays directions for you to adjust the lumbar settings in your seat or to set the massage function. To access and make adjustments to the lumbar setting:

1. Press the Menu Settings icon > Vehicle > Multi-contour Seat.
2. Choose the desired seat to adjust.
3. Press the + or - to adjust the lumbar intensity.

To access and make adjustments to the massage setting:

1. Press the Menu Settings icon > Vehicle > Multi-contour Seat.
2. Choose the desired seat to adjust.
3. Press Off, Low or High.

## **MEMORY FUNCTION (If Equipped)**

### **WARNINGS**



Before activating the memory seat, make sure that the area immediately surrounding the seat is clear of obstructions and that all occupants are clear of moving parts.



Do not use the memory function when your vehicle is moving.

This feature automatically recalls the position of the following:

- Driver seat.
- Power mirrors.
- Optional adjustable pedals.

The memory control is on the driver door.

# Seats



E142554

## Saving a Preset Position

1. Switch the ignition on.
2. Adjust the features to the positions you desire.
3. Press and hold the preset button until you hear a single tone.

**Note:** You can save up to three preset memory positions.

**Note:** You can save a memory preset at any time.

## Recalling a Preset Position

1. Switch the ignition on.
2. Press and release the preset button associated with your desired driving position. The seat and mirrors move to the position stored for that preset.

**Note:** You can only recall preset memory positions when you switch the ignition off, or when the transmission is in park (P) or neutral (N) if you switch the ignition on.

**Note:** You can also recall a preset memory position by pressing the unlock button on your remote control if it is linked to a preset position.

**Note:** Using a linked key fob to recall your memory position when the ignition is off moves the seat to the easy entry position.

**Note:** Pressing any active memory feature control - power seat, mirror (or any memory button) during a memory recall cancels the operation.

## Linking a PreSet Position to your Remote Control or Intelligent Access Key Fob

Your vehicle can save the preset memory positions for up to two remote controls.

1. With the ignition on, move the memory positions to the positions you desire.
2. Press and hold the desired preset button for about five seconds. A tone sounds after about two seconds. Continue holding until you hear a second tone.
3. Within three seconds, press the lock button on the remote control you are linking.

To unlink a remote control, follow the same procedure – except in step 3, press the unlock button on the remote control.

**Note:** If more than one linked remote control or intelligent access key is in range, the memory function moves to the settings of the first key to initiate a memory recall.

## Easy Entry and Exit Feature (if Equipped)

If you enable the easy entry and exit feature, it automatically moves the driver seat rearward up to 2 in (5 cm) when you put the transmission in park (P) and remove the key from the ignition.

The driver seat returns to the previous position when you put the key in the ignition.

You can enable or disable this feature through the information display. See **Information Displays** (page 113).

# Seats

## REAR SEATS (If Equipped)

### Folding Up the Rear Seat Cushion

The rear seat has a split 60/40 cushion. You can flip each seat cushion up into a vertical storage position.



E181250

Rotate the seat cushion up until it locks into the vertical storage position.

### Cushion Lock (If Equipped)

The locking key is in the keyfob. See **Remote Control** (page 56).

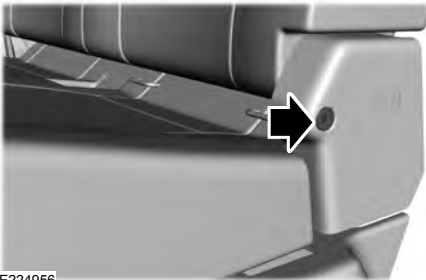

E224956

Turn the key to lock or unlock.

## Returning the Seat to the Seating Position

### WARNING



Check under the seat cushion to make sure no cargo or objects are under the seat cushion before returning the seat cushion to its original position, and that the seat cushion locks into place. Failure to do so may prevent the seat from operating properly in the event of a crash, which could increase the risk of serious injury.



E166704

Pull the control on the bottom of the seat cushion to release it from the storage position.

### Rear Under Seat Storage (If Equipped)

The rear seat has storage space under the seat cushion.

# Seats

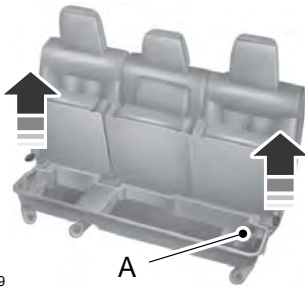

E162739

Lift the lever and flip up the seat cushion to access the storage space and the power point (A).

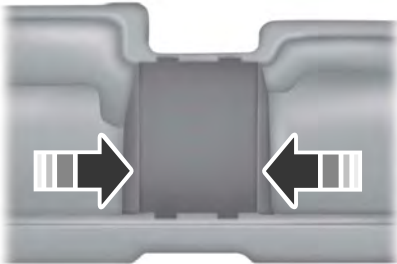

E162740

To remove the storage space divider, squeeze the sides and lift it from the storage tub.



E162741

Use your vehicle key to lock the storage space.

## HEATED SEATS (If Equipped)

### WARNING



People who are unable to feel pain to their skin because of advanced age, chronic illness, diabetes, spinal cord injury, medication, alcohol use, exhaustion or other physical conditions, must exercise care when using the heated seat. The heated seat may cause burns even at low temperatures, especially if used for long periods of time. Do not place anything on the seat that insulates against heat, such as a blanket or cushion. This may cause the heated seat to overheat. Do not puncture the seat with pins, needles or other pointed objects. This may damage the heating element which may cause the heated seat to overheat. An overheated seat may cause serious personal injury.

Do not do the following:

- Place heavy objects on the seat.
- Operate the heated seat if water or any other liquid spills on the seat. Allow the seat to dry thoroughly.

**Note:** *The engine must be running to use this feature.*



E146322

Press the heated seat symbol to cycle through the various heat settings and off. More indicator lights indicate warmer settings.

# Seats

**Note:** The heated seats may remain on after you remote start your vehicle, based on your remote start settings. The heated seats may also turn on when you start your vehicle if they were on when you switched your vehicle off.

## Rear Heated Seats (If Equipped)

### WARNING



People who are unable to feel pain to their skin because of advanced age, chronic illness, diabetes, spinal cord injury, medication, alcohol use, exhaustion or other physical conditions, must exercise care when using the heated seat. The heated seat may cause burns even at low temperatures, especially if used for long periods of time. Do not place anything on the seat that insulates against heat, such as a blanket or cushion. This may cause the heated seat to overheat. Do not puncture the seat with pins, needles or other pointed objects. This may damage the heating element which may cause the heated seat to overheat. An overheated seat may cause serious personal injury.

Do not do the following:

- Place heavy objects on the seat.
- Operate the heated seat if water or any other liquid spills on the seat. Allow the seat to dry thoroughly.

**Note:** The engine must be running to use this feature.

The rear seat heat controls are on the rear of the center console.



E146322

Press the heated seat symbol to cycle through the various heat settings and off. More indicator lights indicate warmer settings.

The heated seat module resets at every ignition run cycle. While the ignition is in the on position, press the heated seat switch to enable heating mode. When activated, they turn off automatically when you switch off the engine.

## CLIMATE CONTROLLED SEATS

(If Equipped)

### Heated Seats

### WARNING



People who are unable to feel pain to their skin because of advanced age, chronic illness, diabetes, spinal cord injury, medication, alcohol use, exhaustion or other physical conditions, must use caution when using the heated seat. The heated seat may cause burns even at low temperatures, especially if used for long periods of time. Do not place anything on the seat that may block the heat, such as a blanket or cushion. This can cause the heated seat to overheat. Do not puncture the seat with pins, needles or other pointed objects. This damages the heating element and can cause the heated seat to overheat. An overheated seat may cause serious personal injury.

# Seats

Do not do the following:

- Place heavy objects on the seat.
- Operate the heated seat if water or any other liquid spills on the seat. Allow the seat to dry thoroughly.

**Note:** The engine must be running to use this feature.



E146322

Press the heated seat symbol to cycle through the various heat settings and off. More indicator lights indicate warmer settings.

**Note:** The heated seats may remain on after you remote start your vehicle, based on your remote start settings. The heated seats may also turn on when you start your vehicle if they were on when you switched your vehicle off.

**Note:** After 60 minutes of operation, the heated seats switch off. Press the heated seat symbol to switch the heated seats on.

## Cooled Seats

**Note:** The engine must be running to use this feature.



E146309

Press the cooled seat symbol to cycle through the various cool settings and off. More indicator lights indicate cooler settings.

**Note:** The cooled seats may remain on after you remote start your vehicle, based on your remote start settings. The heated seats may also turn on when you start your vehicle if they were on when you switched your vehicle off.

**Note:** After 60 minutes of operation, the cooled seats switch off. Press the cooled seat symbol to switch the cooled seats on.

## Climate Controlled Seat Air Filter Replacement

Your vehicle has lifetime air filters that are integrated with the seats. Regular maintenance or replacement is not required.

## FRONT SEAT ARMREST (If Equipped)

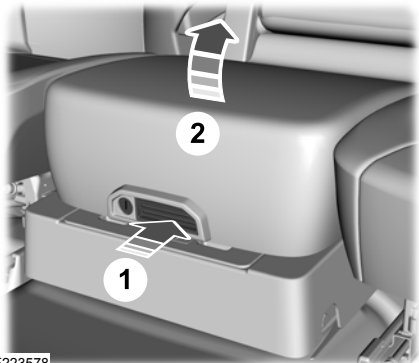

E223578

1. Press the control to release the cushion latch.
2. Lift the cushion to gain access to the storage compartment.

# Seats

The cupholder is located inside the storage compartment. You can also flip the cupholder so that it faces forward. See **Center Console** (page 172).

## Cushion Lock

The locking key is in the keyfob. Remove the cover of the keyfob to access the locking key. See **Remote Control** (page 56).

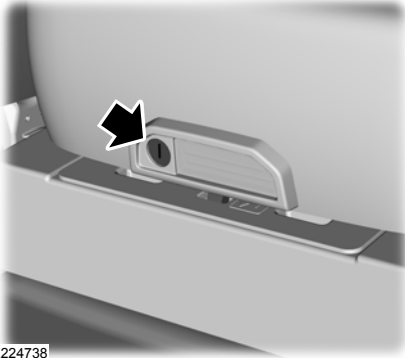

E224738

Turn the key to lock or unlock.

## REAR SEAT ARMREST (If Equipped)



E181222

Pull the strap located on the center seatback to access the armrest and cupholders.

The cupholders are located inside the rear seat armrest.

To open the cupholders:

1. Push in gently on the center of the plastic panel at the front edge of the armrest. The cupholders will partially open.
2. Pull the cupholder fully open before using.



# Universal Garage Door Opener (If Equipped)

## HomeLink Wireless Control System

### WARNINGS



Make sure that the garage door and security device are free from obstruction when you are programming. Do not program the system with the vehicle in the garage.



Do not use the system with any garage door opener that does not have the safety stop and reverse feature as required by U.S. Federal Safety Standards (this includes any garage door opener manufactured before April 1, 1982). A garage door opener which cannot detect an object, signaling the door to stop and reverse, does not meet current federal safety standards. Using a garage door opener without these features increases the risk of serious injury or death.

**Note:** Make sure you keep the original remote control transmitter for use in other vehicles as well as for future system programming.

**Note:** We recommend that upon the sale or lease termination of your vehicle, you erase the programmed function buttons for security reasons. See **Erasing the Function Button Codes** later in this section.

**Note:** You can program a maximum of three devices. To change or replace any of the three devices after it has been initially programmed, you must first erase the current settings. See **Erasing the Function Button Codes**.



E188211

The universal garage door opener replaces the common hand-held garage door opener with a three-button transmitter integrated into the driver's sun visor.

The system includes two primary features, a garage door opener and a platform for remote activation of devices within the home. You can program garage doors as well as entry gate operators, security systems, entry door locks and home or office lighting.

Additional system information can be found online at [www.homelink.com](http://www.homelink.com), [www.youtube.com/user/HomeLinkGentex](http://www.youtube.com/user/HomeLinkGentex) or by calling the toll-free help line at 1-800-355-3515.

### In-Vehicle Programming

This process is to program your in-vehicle HomeLink function button with your hand-held transmitter.

**Note:** The programming steps below assume you will be programming HomeLink that was not previously programmed. If your HomeLink was previously programmed, you may need to erase your HomeLink buttons. See **Erasing the Function Button Codes**.

**Note:** Put a new battery in the hand-held transmitter. This helps ensure quicker training and accurate transmission of the radio-frequency signal.

## Universal Garage Door Opener (If Equipped)

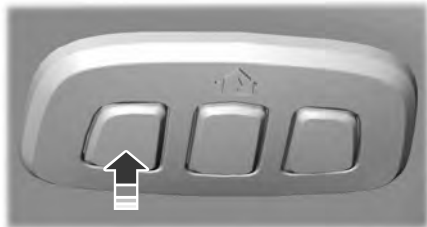

E188212

1. With your vehicle parked outside of the garage, switch your ignition to the **on** position, but do not start your vehicle.
2. Press and release the function button that you would like to program.
3. Hold your hand-held garage door transmitter 1–3 in (2–8 cm) away from the HomeLink button you want to program.
4. Press and hold the hand-held transmitter button you want to program while watching the indicator light on HomeLink. Continue to hold the hand-held button until the HomeLink indicator light flashes rapidly or is continuously on.

**Note:** *You may need to use a different method if you live in Canada or have difficulties programming your gate operator or garage door opener. See **Gate Operator / Canadian Programming.***

5. Press and hold the HomeLink button you programmed for two seconds, then release. You may need to do this twice to activate the door. If your garage door does not operate, watch the HomeLink indicator light.

**If the indicator light stays on, the programming is complete. Your device should activate when the HomeLink button is pressed and released.**

If the indicator light flashes rapidly, press and hold for two seconds and release the programmed HomeLink button. Repeat the "press/hold/release" sequence up to three times to complete the programming process. If your device still does not operate, you must program your garage door. See **Programming Your Garage Door Opener Motor.**

To program additional buttons, repeat Steps 1 – 4.

For questions or comments, please contact HomeLink at [www.homelink.com](http://www.homelink.com), [www.youtube.com/user/HomeLinkGentex](http://www.youtube.com/user/HomeLinkGentex) or by calling the toll-free help line at 1-800-355-3515.

### Programming Your Garage Door Opener Motor

**Note:** *You may need a ladder to reach the unit and you may need to remove the cover or lamp lens on your garage door opener.*



E142659

1. Press the learn button on the garage door opener motor and then you have 30 seconds to complete the next two steps.
2. Return to your vehicle.

# Universal Garage Door Opener (If Equipped)



E188212

3. Press and hold the function button you want to program for 2 seconds, then release. Repeat this step. Depending on your brand of garage door opener, you may need to repeat this sequence a third time.

## Gate Operator / Canadian Programming

Canadian radio-frequency laws require transmitter signals to “time-out” (or quit) after several seconds of transmission – which may not be long enough for HomeLink to pick up the signal during programming. Similar to this Canadian law, some U.S. gate operators are designed to “time-out” in the same manner.

**Note:** *If programming a garage door opener or gate operator, it is advised to unplug the device during the “cycling” process to prevent possible overheating.*

1. Press and release, **every two seconds**, your hand-held transmitter until the HomeLink indicator light changes to a rapidly blinking or continuously on light.
2. Release the hand-held transmitter button.
3. Continue programming HomeLink. See **In-Vehicle Programming, Step 4.**

## Erasing the Function Button Codes

**Note:** *You cannot erase individual buttons.*

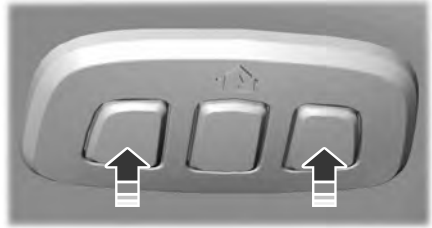

E188213

1. Press and hold the outer two function buttons simultaneously for approximately 10 seconds until the indicator light above the buttons flashes rapidly.
2. When the indicator light flashes, release the buttons. You erased the codes for all buttons.

## Reprogramming a Single Button

To program a device to a previously trained button, follow these steps:

1. Press and hold the desired button. Do NOT release the button.
2. The indicator light begins to flash after 20 seconds. Without releasing the button, follow Step 1 in the Programming section.

For questions or comments, contact HomeLink at [www.homelink.com](http://www.homelink.com), [www.youtube.com/user/HomeLinkGentex](http://www.youtube.com/user/HomeLinkGentex) or by calling the toll-free help line at 1-800-355-3515.

# Universal Garage Door Opener (If Equipped)

---

## **FCC and RSS-210 Industry Canada Compliance**

This device complies with Part 15 of the FCC Rules and with RSS-210 of Industry Canada. Operation is subject to the following two conditions: (1) this device may not cause harmful interference, and (2) this device must accept any interference received, including interference that may cause undesired operation.

**Note:** *Changes or modifications to your device not expressly approved by the party responsible for compliance can void the user's authority to operate the equipment.*

This equipment complies with FCC radiation exposure limits set forth for an uncontrolled environment. End Users must follow the specific operating instructions for satisfying RF exposure compliance. This transmitter must be at least 8 in (20 cm) from the user and must not be co-located or operating in conjunction with any other antenna or transmitter.

The term "IC:" before the certification/registration number only signifies that Industry Canada technical specifications were met.

# Auxiliary Power Points

## 12 Volt DC Power Point

### WARNING



Do not plug optional electrical accessories into the cigar lighter socket. Incorrect use of the cigar lighter can cause damage not covered by the vehicle warranty, and can result in fire or serious injury.

**Note:** When you switch the ignition on, you can use the socket to power 12 volt appliances with a maximum current rating of 20 amps.

**Note:** Do not plug in any device that supplies power to the vehicle through the power points, this may result in damage to vehicle systems.

**Note:** Do not hang any accessory from the accessory plug.

**Note:** Do not use the power point over the vehicle capacity of 12 volt DC 240 watts or a fuse may blow.

**Note:** Always keep the power point caps closed when not in use.

Do not insert objects other than an accessory plug into the power point. This damages the power point and may blow the fuse.

Run the vehicle for full capacity use of the power point.

To prevent the battery from running out of charge:

- Do not use the power point longer than necessary when the engine is off.
- Do not leave devices plugged in overnight or when you park your vehicle for extended periods.

## Locations

**Note:** Timed power points remain on for 30 minutes if the vehicle is in accessory mode. If you switch the vehicle off, the timed power points remain on for 75 minutes.

Power points may be in the following locations:

- On the instrument panel.
- Inside the center console.
- On the rear of the center console.
- In the seat bin.

## 110 Volt - 400 Watt Capacity AC Power Outlet

### WARNING



Do not keep electrical devices plugged in the power point whenever the device is not in use. Do not use any extension cord with the 110 volt AC power point, since it will defeat the safety protection design. Doing so may cause the power point to overload due to powering multiple devices that can reach beyond the 400 watt load limit and could result in fire or serious injury.

**Note:** This feature works only when the engine is running.

**Note:** This feature has a maximum output of 400 watts when the vehicle is in park (P).

**Note:** While in drive (D), the maximum outlet output is 300 watts.

**Note:** When powering electric devices that require more than 10 watts in vehicles equipped with keyless start, the engine must remain running. If the engine is turned off or you switch the ignition to accessory mode, plugged in devices will not be charged.

You can use the power point for electric devices that require up to 400 watts. It is on the instrument panel and rear of the center console.

## Auxiliary Power Points

---



E191617

When the indicator light on the power point is:

- On: The power point is working, the ignition is on and a device is plugged in.
- Off: The power point is off, the ignition is off or no device is plugged in.
- Flashing: The power point is in fault mode.

The power outlet temporarily turns off power when in fault mode if the device exceeds the 400 watt limit. Unplug your device and switch the ignition off. Switch the ignition back on, but do not plug your device back in. Let the system cool off and switch the ignition off to reset the fault mode. Switch the ignition back on and make sure the indicator light remains on.

You can use the 400 watt power outlet for these types of electric devices:

- Electric hand drills.
- Rechargeable power tools.
- Video games.
- Laptops.
- Televisions.

**Note:** *Max 400W - when the vehicle is parked and 300W - when the vehicle is driving.*

Do not use the power point for certain electric devices, including:

- Cathode-ray, tube-type televisions.
- Motor loads, such as vacuum cleaners, electric saws and other electric power tools or compressor-driven refrigerators.
- Measuring devices, which process precise data, such as medical equipment or measuring equipment.
- Other appliances requiring an extremely stable power supply such as microcomputer-controlled electric blankets or touch-sensor lamps.

# Storage Compartments

## CENTER CONSOLE (If Equipped)

Stow items in the cup holder carefully as items may become loose during hard braking, acceleration or crashes, including hot drinks which may spill.

Available console features include:

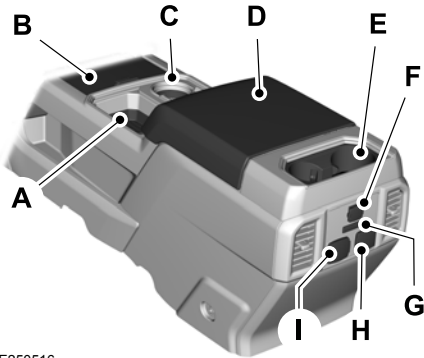

E250516

- A Storage compartment.
- B Front storage compartment with USB ports.
- C Sliding cup holder.
- D Center storage compartment with auxiliary power point.
- E Rear cup holders.
- F AC power point.
- G Heated rear seats.
- H Auxiliary power point.
- I USB charging ports.

## OVERHEAD CONSOLE (If Equipped)

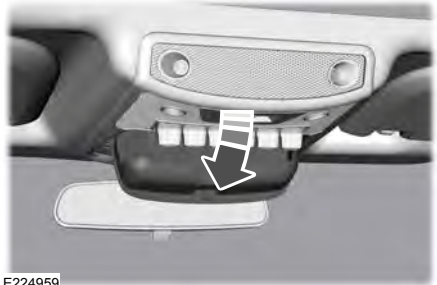

E224959

Press near the rear edge of the door to open it.

## UNDER SEAT STORAGE

### Rear Under Seat Storage

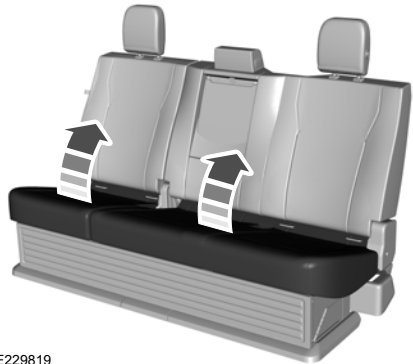

E229819

1. Lift rear seat to access under seat storage bin.

## Storage Compartments

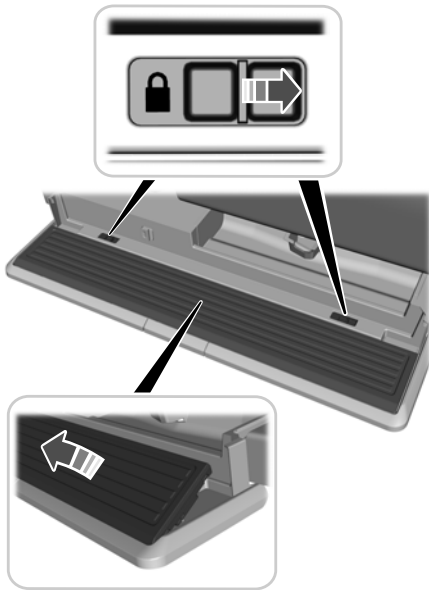

E235007

2. Lift front and side panels to expand and lock them in place.

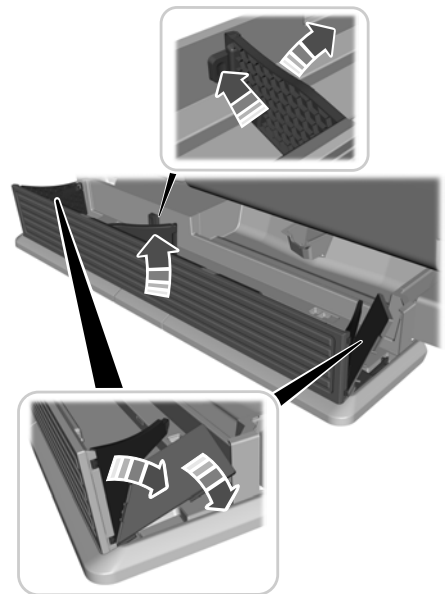

E235008

3. Lock the panels in an open position.

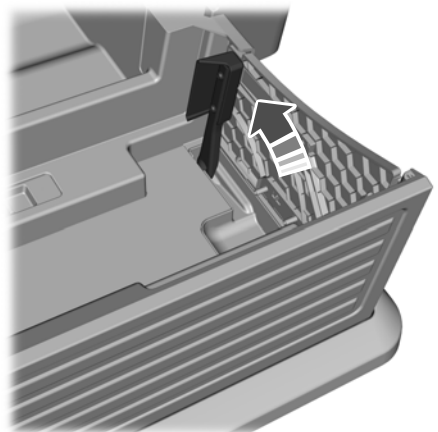

E235009



## Storage Compartments

---

4. To collapse, lift lever and fold in the side and front panels.

**Note:** *Make sure the storage divider is not locked into place when collapsing.*

# Starting and Stopping the Engine

## GENERAL INFORMATION

### WARNINGS

 Extended idling at high engine speeds can produce very high temperatures in the engine and exhaust system, creating the risk of fire or other damage.

 Do not park, idle or drive your vehicle on dry grass or other dry ground cover. The emission system heats up the engine compartment and exhaust system, creating the risk of fire.

 Do not start the engine in a closed garage or in other enclosed areas. Exhaust fumes can be toxic. Always open the garage door before you start the engine.

 Exhaust leaks may result in entry of harmful and potentially lethal fumes into the passenger compartment. If you smell exhaust fumes inside your vehicle, have your vehicle inspected immediately. Do not drive if you smell exhaust fumes.

If you disconnect the battery, your vehicle may exhibit some unusual driving characteristics for approximately 5.0 mi (8 km) after you reconnect it. This is because the engine management system must realign itself with the engine. You can disregard any unusual driving characteristics during this period.

The powertrain control system meets all Canadian interference-causing equipment standard requirements regulating the impulse electrical field or radio noise.

When you start the engine, avoid pressing the accelerator pedal before and during operation. Only use the accelerator pedal when you have difficulty starting the engine.

If your vehicle is operated in a heavy snow storm or blowing snow conditions, the engine air induction may become partially clogged with snow and ice. If this occurs, the engine may experience a significant reduction in power output. At the earliest opportunity, clear all the snow and ice away from the air induction inlet.

## IGNITION SWITCH (If Equipped)

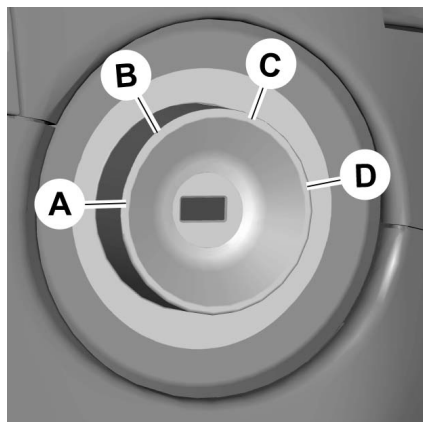

E252522

**A** (off) - The ignition is off.

**Note:** When you switch the ignition off and leave your vehicle, do not leave your key in the ignition. This could cause your vehicle battery to lose charge.

**B** (accessory) - Allows the electrical accessories, such as the radio, to operate while the engine is not running.

**Note:** Do not leave the ignition key in this position for too long. This could cause your vehicle battery to lose charge.

**C** (on) - All electrical circuits are operational and the warning lamps and indicators illuminate.

# Starting and Stopping the Engine

**D** (start) - Cranks the engine.

## KEYLESS STARTING

**Note:** The system may not function if the intelligent access key is close to metal objects or electronic devices, for example keys or a cell phone.

**Note:** A valid intelligent access key must be located inside your vehicle to switch the ignition on and start your vehicle.

## Ignition Modes



E144447

The keyless starting system has three modes:

**Off:** Turns the ignition off.

- Without applying the brake pedal, press and release the button once when the ignition is in the on mode, or when your vehicle is running but is not moving.

**On:** All electrical circuits are operational and the warning lamps and indicators illuminate.

- Without applying the brake pedal, press and release the button once.

**Start:** Starts your vehicle. The engine may not start when your vehicle starts.

- Press the brake pedal, and then press the button for any length of time. An indicator light on the button illuminates when the ignition is on and when your vehicle starts.

## STARTING A GASOLINE ENGINE - 6.2L/6.8L

When you start the engine, the idle speed increases. This helps to warm up the engine.

If the engine idle speed does not slow down automatically, have your vehicle checked by an authorized dealer.

Before starting the engine check the following:

- Make sure all occupants have fastened their safety belts.
- Make sure the headlamps and electrical accessories are off.
- Make sure the parking brake is on.
- Move the transmission selector lever to position P.
- Turn the ignition key to the on position.

**Note:** Do not touch the accelerator pedal.

1. Fully depress the brake pedal.
2. Turn the key to the start position to start your vehicle.
3. When the engine starts, release the key and then gradually release the brake pedal as the engine speed increases.

**Note:** The engine may continue cranking for up to 15 seconds or until it starts.

**Note:** If you cannot start the engine on the first try, wait for a short period and try again.

## Vehicles with an Ignition Key

**Note:** Do not touch the accelerator pedal.

1. Fully depress the brake pedal.

# Starting and Stopping the Engine

2. Turn the key to position **D** to start the engine.
3. When the engine starts, release the brake pedal.

Do not crank the engine for more than 10 seconds as starter damage may occur. If the engine does not start, switch the ignition off and wait 30 seconds before trying again.

## Vehicles with Keyless Start

**Note:** Do not touch the accelerator pedal.

**Note:** If the push button ignition switch is pressed again prior to the engine starting the ignition will switch to accessory mode and will not start.

**Note:** If the brake pedal is released before the engine has started, follow the engine start sequence again.

1. Fully depress the brake pedal.
2. Press the center of the push button ignition switch.
3. When the engine starts, release the brake pedal.

## Failure to Start

If you cannot start the engine after three attempts, wait 10 seconds and follow this procedure:

1. Fully depress the brake pedal.
2. Fully press the accelerator pedal and hold it there.
3. Start the engine.

## Stopping the Engine When Your Vehicle is Stationary

1. When your vehicle has stopped, shift into park (P) and switch the ignition off.
2. Apply the parking brake.

## Stopping the Engine When Your Vehicle is Moving

### WARNING



Switching off the engine when your vehicle is still moving results in a significant decrease in braking assistance. Higher effort is required to apply the brakes and to stop your vehicle. A significant decrease in steering assistance could also occur. The steering does not lock, but higher effort could be required to steer your vehicle. When you switch the ignition off, some electrical circuits, for example airbags, also turn off. If you unintentionally switch the ignition off, shift into neutral (N) and restart the engine.

1. Put the transmission into neutral (N) and use the brakes to bring your vehicle to a safe stop.
2. When your vehicle has stopped, shift into park (P) and switch the ignition off.
3. Apply the parking brake.

## Automatic Engine Shutdown

If your vehicle is equipped with a keyless ignition, it has a feature that automatically shuts down the engine if it has been idling for an extended period of time. The ignition also turns off in order to save battery power. Before the engine shuts down, a message appears in the information display showing a timer counting down from 30 seconds. If you do not intervene within 30 seconds, the engine shuts down. Another message appears in the information display to inform you that the engine has shut down in order to save fuel. Start your vehicle as you normally do.

# Starting and Stopping the Engine

## Cold Weather Starting (Flexible Fuel Vehicles Only)

The starting characteristics of all grades of E85 ethanol make it unsuitable for use when ambient temperatures fall below 0°F (-18°C). Consult your fuel distributor for the availability of winter grade ethanol. As the outside temperature approaches freezing, ethanol fuel distributors should supply winter grade ethanol, the same as with unleaded gasoline.

If summer grade ethanol is used in cold weather conditions, 0°F (-18°C), you may experience increased cranking times, rough idle or hesitation until the engine has warmed up.

You may experience a decrease in performance when the engine is cold when operating on E85 ethanol.

Do not use starting fluid such as ether in the air intake system. Such fluid could cause immediate explosive damage to the engine and possible personal injury.

If you should experience cold weather starting problems on E85 ethanol, and neither an alternative brand of E85 ethanol nor an engine block heater is available, the addition of unleaded gasoline to your tank improves cold starting performance. Your vehicle is designed to operate on E85 ethanol alone, unleaded gasoline alone, or any mixture of the two.

### If the Engine Fails to Start Using the Preceding Instructions (Flexible Fuel Vehicles Only)

1. Press the accelerator pedal down one-third to one-half of its travel, and then crank the engine.
2. When the engine starts, release the key, then gradually release the accelerator pedal as the engine speed increases. If the engine still does not start, repeat Step 1.

## Guarding Against Exhaust Fumes

### WARNING



Exhaust leaks may result in entry of harmful and potentially lethal fumes into the passenger compartment. If you smell exhaust fumes inside your vehicle, have your vehicle inspected immediately. Do not drive if you smell exhaust fumes.

## Important Ventilating Information

If you stop your vehicle and then leave the engine idling for long periods of time, we recommend that you do one of the following:

- Open the windows at least 1 inch (2.5 centimeters).
- Set your climate control to outside air.

## STARTING A DIESEL ENGINE - 6.7L DIESEL

Read all starting instructions carefully before you start your vehicle.

For temperatures below 32°F (0°C), the use of the correct grade engine oil is essential for proper operation. Refer to engine oil specifications for more information. See **Capacities and Specifications** (page 432).

Your vehicle may have a cold weather starting strategy that prevents severe engine damage by assisting in engine lubrication warm-up. In extremely cold ambient temperatures, this strategy activates and prevents the accelerator pedal from being used for 30 seconds after you start your vehicle. A message appears in the information display as your vehicle warms up. By not allowing the accelerator pedal to be used, the engine oil is allowed to properly lubricate the bearings

# Starting and Stopping the Engine

preventing engine damage due to lack of proper lubrication. After the 30 second warm-up period, the accelerator pedal will be operational again and a message appears informing you the vehicle is ok to drive.

When you start the engine in extremely cold temperatures -15°F (-26°C), we recommend that you allow the engine to idle for several minutes before you drive the vehicle.

Before starting the engine check the following:

- Make sure all occupants have fastened their seatbelts.
- Make sure the headlamps and electrical accessories are off.
- Make sure the parking brake is on.
- Make sure the transmission is in park (P).

**Note:** Do not press the accelerator during starting.

## Vehicles with an Ignition Key

**Note:** Do not touch the accelerator pedal.

1. Fully depress the brake pedal.
2. Turn the key to position **C**

**Note:** A message will appear Engine Start Pending, Please Wait.

3. Wait until the engine glow-plug indicator turns off.
4. Turn the key to position **D** to start the engine.
5. When the engine starts, release the brake pedal.

Do not crank the engine for more than 10 seconds as starter damage may occur. If the engine does not start, switch the ignition off and wait 30 seconds before trying again.

## Vehicles with Keyless Start

**Note:** Do not touch the accelerator pedal.

**Note:** If the push button ignition switch is pressed again prior to the engine starting the ignition will switch to accessory mode and will not start.

**Note:** If the brake pedal is released before the engine has started, follow the engine start sequence again.

1. Fully depress the brake pedal.
2. Press the center of the push button ignition switch.

**Note:** A message will appear Engine Start Pending, Please Wait.

3. When the engine starts, release the brake pedal.

## Diesel Engine Fast Start Glow Plug System

The diesel engine glow system consists of:

- Eight glow plugs (one per cylinder)
- Glow Plug Control Module
- Engine Coolant Temperature sensor
- Barometric pressure sensor
- Environmental temperature sensor

The powertrain and glow plug control modules electronically control the glow plug system. After you switch the ignition on, the glow plug control module immediately energizes the glow plugs. The glow plug control module uses the engine coolant temperature, barometric pressure sensor and environmental temperature sensor to determine how long the glow plugs stay energized. The required time for the glow plugs to be energized decreases as the coolant temperature, barometric pressure and environmental temperature increase.

# Starting and Stopping the Engine

## Automatic Engine Shutdown

If your vehicle is equipped with a keyless ignition, it has a feature that automatically shuts down the engine if it has been idling for an extended period. The ignition also turns off in order to save battery power. Before the engine shuts down, a message appears in the information display showing a timer counting down from 30 seconds. If you do not intervene within 30 seconds, the engine shuts down. Another message appears in the information display to inform you that the engine has shut down in order to save fuel. Start your vehicle as you normally do.

## Cold Weather Starting

### WARNINGS



Do not use starting fluid, for example ether, in the air intake system. Such fluid could cause immediate explosive damage to the engine and possible personal injury.



Do not add gasoline, gasohol, alcohol or kerosene to diesel fuel. This creates a serious fire hazard and causes engine performance problems.

We recommend that the engine block heater be used for starting when the temperature is -9°F (-23°C) or colder. See **Engine Block Heater** (page 183).

When operating in cold weather, you may use Motorcraft® cetane improvers or non-alcohol-based cetane improvers from a reputable manufacturer as needed.



Switch the ignition on. Do not start the engine until the glow-plug indicator turns off.

When the glow plug pre-heat indicator turns off, turn the key to start. After you start the engine, the glow plugs may remain on for a period. If you do not start the engine before the glow plug activation time ends, you will need to reset the glow plugs by switching the ignition off. After the engine starts, allow it to idle for about 15 seconds. This protects the engine. Do not increase engine speed until the oil pressure gauge indicates normal pressure.

## Cold Weather Operation

**Note:** *Idling in cold weather does not heat the engine to its normal operating temperature. Long periods of idling, especially in cold weather, can cause a buildup of deposits which can cause engine damage.*

Change to a lighter grade engine oil to make starting easier under these conditions. Refer to engine oil specifications. See **Capacities and Specifications** (page 432).

Diesel fuel is adjusted seasonally for cold temperatures. Diesel fuel which has not been properly formulated for the ambient conditions may gel which can clog the fuel filters. One indication that the fuel filter(s) may be clogged is if the engine starts, stalls after a short time, and then does not restart. If you have been using biodiesel, you may need to use a fuel with lower biodiesel content, try another brand, or discontinue using biodiesel. Do not use alcohol based additives to correct fuel gelling. This may result in damage to the fuel injectors and system. Use the proper anti-gel and performance improvement product. See **Capacities and Specifications** (page 432).

# Starting and Stopping the Engine

Your vehicle has a fuel and water separator that recirculates fuel from the engine to help prevent fuel filter clogging. To avoid engine fuel starvation during cold weather operation of 32°F (0°C) or below, we recommend that the fuel level in your tank should not drop below ¼ full. This helps prevent air from entering the fuel system and stalling the engine.

Your vehicle has a selective catalytic reduction system that uses Diesel Exhaust Fluid (DEF) to operate properly. You need to replenish your vehicle's DEF at certain intervals. When filling your vehicle's DEF tank in cold weather, take special care to prevent damage to the tank. See **Selective Catalytic Reductant System** (page 198).

In cold weather below 32°F (0°C), the engine may slowly increase to a higher idle speed if you leave it idling in park (P). As the engine warms-up, the engine sound level decreases due to the activation of PCM-controlled sound reduction features.

If you operate your vehicle in a heavy snowstorm or blowing snow conditions, snow and ice can clog the engine air induction. If this occurs, the engine may experience a significant reduction in power output. At the earliest opportunity, clear all the snow and ice away from inside the air filter assembly. Remove the air cleaner cover and the air filter and remove any snow or ice. Remove any debris, snow or ice, on the foam filter by brushing the surface with a soft brush. Once you have cleared all of the debris, reinstall the air filter and cover.

Do not use water, solvents, or a hard brush for cleaning the foam filter.

## WARNING



To reduce the risk of vehicle damage and personal burn injuries, do not start your engine with the air cleaner removed and do not remove it while the engine is running.

In order to operate the engine in temperatures of 32°F (0°C) or lower, read the following instructions:

- Make sure that the batteries are of sufficient size and are fully charged. Check other electrical components to make sure they are in optimum condition.
- Use the proper coolant solution at the concentration recommended protecting the engine against damage from freezing.
- Try to keep the fuel tank full as much as possible at the end of operation to prevent condensation in the fuel system.
- Make sure you use proper cold weather engine oil and that it is at its proper level. Also, if necessary, make sure to follow the engine oil and filter change schedule found under the Special operating conditions section listed in the scheduled maintenance information.
- At temperatures of -9°F (-23°C) or below, it is recommended that you use an engine block heater to improve cold engine starting.
- If operating in arctic temperatures of -20°F (-29°C) or lower, consult your truck dealer for information about special cold weather equipment and precautions.



# Starting and Stopping the Engine

We recommend the following cold weather idling guidelines:

- You can use Motorcraft® cetane improvers or non-alcohol-based cetane improvers from a reputable manufacturer as needed.
- Maintain the engine cooling system properly.
- Avoid shutting the engine down after an extensive idling period. Drive your vehicle for several miles with the engine at normal operating temperatures under a moderate load.
- Consider using an engine block heater.
- For extended idle times use an approved idle speed increase device.

## Winter Operating Tips for Arctic Operation -20°F (-29°C) and Below

The following information is a guideline only and is not to be the only source of possible solutions in resolving extreme cold temperature issues.

### Starting Aids

#### WARNING



Do not use starting fluid, for example ether, in the air intake system. Such fluid could cause immediate explosive damage to the engine and possible personal injury.

The use of the factory engine block heater assists in engine starting in extreme cold ambient temperatures. See **Engine Block Heater** (page 183).

### Idle Control

Your vehicle may have a factory option for a stationary elevated idle control through the upfitter switches in the overhead console. This allows the operator to elevate the idle RPM for extended idle periods, as well as aftermarket equipment such as PTO operation. You must configure this feature even if ordered from the factory. See your authorized dealer for required upfitting.

### Operation in Snow and Rain

Vehicle operation in heavy snowfall or extreme rain conditions may feed excessive amounts of snow or water into the air intake system. This could plug the air filter with snow and may cause the engine to lose power and possibly shut down.

We recommend the following actions after operating your vehicle up to 200 mi (320 km) in snowfall or extreme rain:

- Snow: At the earliest opportunity, open the hood and clear all the snow and ice from the air filter housing inlet (do not remove the foam filter) and reset the air filter restriction gauge.

**Note:** *Removal of the foam filter degrades your vehicle performance during snow and hot weather conditions.*

- Extreme rain: The air filter dries after about 15–30 minutes at highway speeds. At the earliest opportunity, open the hood and reset the air filter restriction gauge.

Refer to Air filter and restriction gauge in the Maintenance chapter for more information. See **Changing the Engine Air Filter** (page 363).

# Starting and Stopping the Engine

## Operation in Standing Water

Ingestion of water into the diesel engine can result in immediate and severe damage to the engine. If driving through water, slow down to avoid splashing water into the intake. If the engine stalls, and you suspect ingestion of water into the engine, do not try to restart the engine. Consult your dealer for service immediately.

Your fuel tank vents to the atmosphere by valves on top of the tank and through the fuel cap. If water reaches the top of the tank, the valves may pull water into the fuel tank. Water in the fuel can cause performance issues and damage the fuel injection system.

## SWITCHING OFF THE ENGINE - 6.7L DIESEL

Switch the ignition off.

To help prolong engine life, we recommend you allow the engine to idle for three to five minutes, especially after any of the following:

- Continuous engine speed.
- High ambient temperature.
- High GVW or GCW operation, for example heavy loads or trailers.

This allows the turbo charged engine to cool down.

## ENGINE IDLE SHUTDOWN

Your vehicle may be equipped with an engine idle shutdown system. This system automatically shuts down your engine when it has been idling in **P** (Park) or **N** (Neutral) for five minutes (parking brake set) or 15 minutes (parking brake not set). When the engine idle shutdown process has started:

- A chime sounds and the information display will show ENGINE TURNS OFF IN 30 (seconds) and start counting down
- You can restart the five or 15-minute timer by changing the position of the accelerator pedal, brake pedal or the park brake within the final 30 seconds
- When the timer reaches zero, the engine shuts down and this message will appear in your information display ENGINE TURNED OFF
- One minute after the engine has shut down, the electrical system simulates key off, even though the ignition is still in the on position, initiating normal accessory delay period
- You must move the ignition to the off position to reset the system before restarting your vehicle.

The engine idle shutdown idle timer does not start if:

- The engine is operating in power take-off mode.
- The engine coolant temperature is below 60°F (16°C).
- The exhaust emission control device is regenerating.

## ENGINE BLOCK HEATER (if

Equipped)

### WARNINGS



Failure to follow engine block heater instructions could result in property damage or serious personal injury.



Do not use your heater with ungrounded electrical systems or two-pronged adapters. There is a risk of electrical shock.

# Starting and Stopping the Engine

**Note:** The heater is most effective when outdoor temperatures are below 0°F (-18°C).

For cold climates that are below 0°F (-18°C) needing a temporary battery installation. Order the cold climate pack.

The heater acts as a starting aid by warming the engine coolant. This allows the climate control system to respond quickly. The equipment includes a heater element (installed in the engine block) and a wire harness. You can connect the system to a grounded 120-volt AC electrical source.

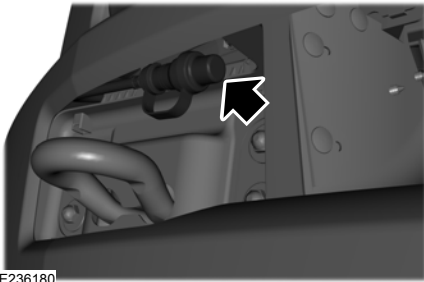

We recommend that you do the following for a safe and correct operation:

- Make sure your vehicle is parked in a clean area, clear of combustibles.
- locate the block heater cord in the front tow hook pocket.
- Use a 16-gauge outdoor extension cord that is product certified by Underwriter's Laboratory (UL) or Canadian Standards Association (CSA). This extension cord must be suitable for use outdoors, in cold temperatures, and be clearly marked Suitable for Use with Outdoor Appliances. Do not use an indoor extension cord outdoors. This could result in an electric shock or become a fire hazard.

- Use as short an extension cord as possible.
- Do not use multiple extension cords.
- Make sure that when in operation, the extension cord plug and heater cord plug connections are free and clear of water. This could cause an electric shock or fire.
- Make sure the heater, heater cord and extension cord are firmly connected.
- Check for heat anywhere in the electrical hookup once the system has been operating for approximately 30 minutes.
- Make sure the system is unplugged and properly stowed before starting and driving your vehicle. Make sure the protective cover seals the prongs of the block heater cord plug when not in use.
- Make sure the heater system is checked for proper operation before winter.

## Using the Engine Block Heater

Make sure the receptacle terminals are clean and dry prior to use. Clean them with a dry cloth if necessary.

The heater uses 0.4 to 1.0 kilowatt-hours of energy per hour of use. The system does not have a thermostat. It achieves maximum temperature after approximately three hours of operation. Using the heater longer than three hours does not improve system performance and unnecessarily uses electricity.

# Fuel and Refueling

## SAFETY PRECAUTIONS

### WARNINGS



Do not overfill the fuel tank. The pressure in an overfilled tank may cause leakage and lead to fuel spray and fire.



The fuel system may be under pressure. If you hear a hissing sound near the fuel filler inlet, do not refuel until the sound stops. Otherwise, fuel may spray out, which could cause serious personal injury.



Automotive fuels can cause serious injury or death if misused or mishandled.



Flow of fuel through a fuel pump nozzle can produce static electricity. This can cause a fire if you are filling an ungrounded fuel container.



Fuel may contain benzene, which is a cancer-causing agent.



When refueling always shut the engine off and never allow sparks or open flames near the fuel tank filler valve. Never smoke or use a cell phone while refueling. Fuel vapor is extremely hazardous under certain conditions. Avoid inhaling excess fumes.

Observe the following guidelines when handling automotive fuel:

- Extinguish all smoking materials and any open flames before refueling your vehicle.
- Always turn off the vehicle before refueling.
- Automotive fuels can be harmful or fatal if swallowed. Fuel such as gasoline is highly toxic and if swallowed can cause death or permanent injury. If fuel is swallowed, call a physician immediately, even if no symptoms are immediately apparent. The toxic effects of fuel may not be visible for hours.
- Avoid inhaling fuel vapors. Inhaling too much fuel vapor of any kind can lead to eye and respiratory tract irritation. In severe cases, excessive or prolonged breathing of fuel vapor can cause serious illness and permanent injury.
- Avoid getting fuel liquid in your eyes. If fuel is splashed in the eyes, remove contact lenses (if worn), flush with water for 15 minutes and seek medical attention. Failure to seek proper medical attention could lead to permanent injury.
- Fuels can also be harmful if absorbed through the skin. If fuel is splashed on the skin, clothing or both, promptly remove contaminated clothing and wash skin thoroughly with soap and water. Repeated or prolonged skin contact with fuel liquid or vapor causes skin irritation.
- Be particularly careful if you are taking Antabuse or other forms of Disulfiram for the treatment of alcoholism. Breathing gasoline vapors could cause an adverse reaction, serious personal injury or sickness. If fuel is splashed on the skin, wash the affected areas immediately with plenty of soap and water. Consult a physician immediately if you experience any adverse reactions.

# Fuel and Refueling

## FUEL QUALITY - E85

### Choosing the Right Fuel - Flex Fuel Vehicles

Flex fuel vehicles have one of the following identifiers:

- Yellow fuel filler cap.
- Yellow bezel around the fuel filler inlet.
- Yellow fuel filler housing.
- Yellow E85 label on the fuel tank filler door.

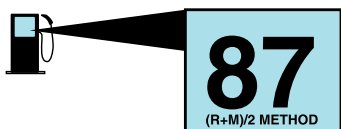

E161513

Your vehicle is designed to operate on regular unleaded gasoline with a minimum pump (R+M)/2 octane rating of 87 or regular unleaded gasoline blended with a maximum of 85% ethanol (E85).

Some fuel stations, particularly those in high altitude areas, offer fuels posted as regular unleaded gasoline with an octane rating below 87.

For best overall vehicle and engine performance, premium fuel with an octane rating of 91 or higher is recommended. The performance gained by using premium fuel is most noticeable in hot weather as well as other conditions, for example when towing a trailer. See **Towing** (page 272).

Do not be concerned if the engine sometimes knocks lightly. However, if the engine knocks heavily while using fuel with the recommended octane rating, contact an authorized dealer to prevent any engine damage.

We recommend Top Tier detergent gasolines, where available to help minimize engine deposits and maintain optimal vehicle and engine performance. For additional information, refer to [www.toptiergas.com](http://www.toptiergas.com).

**Note:** *Use of any fuel for which the vehicle was not designed can impair the emission control system, cause loss of vehicle performance, and cause damage to the engine which may not be covered by the vehicle Warranty.*

Do not use:

- Diesel fuel.
- Fuels containing kerosene or paraffin.
- Fuels containing more than 85% ethanol or E100 fuel.
- Fuels containing methanol.
- Fuels containing metallic-based additives, including manganese-based compounds.
- Fuels containing the octane booster additive, methylcyclopentadienyl manganese tricarbonyl (MMT).
- Leaded fuel, using leaded fuel is prohibited by law.

The use of fuels with metallic compounds such as methylcyclopentadienyl manganese tricarbonyl (commonly known as MMT), which is a manganese-based fuel additive, will impair engine performance and affect the emission control system.

# Fuel and Refueling

## Switching Between E85 and Gasoline

We do not recommend repeatedly alternating between E85 and gasoline. If you switch from using E85 to gasoline, or from gasoline to E85, add as much fuel as possible, at least half a tank. Drive your vehicle immediately for a minimum of 5 mi (8 km) to allow it to adapt to the change in ethanol concentration. If you use E85 exclusively, we recommend that you fill the fuel tank with regular unleaded gasoline at each scheduled oil change.

## FUEL QUALITY - DIESEL

### Fuel Requirements - Choosing The Right Fuel: Vehicles Operated Where Ultra Low Sulfur Diesel Fuel Is Required (United States/Canada/Puerto Rico/U.S. Virgin Islands And Other Locales)

You should use Ultra-Low Sulfur Diesel fuel (also known as ULSD) designated as number 1-D or 2-D with a maximum of 15-ppm sulfur in your diesel vehicle. You may operate your vehicle on diesel fuels containing up to 20% biodiesel, also known as B20. These fuels should meet the ASTM D975 diesel or the ASTM D7467 B6-B20 biodiesel industry specifications. Outside of North America, use fuels meeting EN590 or equivalent local market standard.

**Note:** *The vehicle Warranty does not cover damage caused by using an improper type of fuel or fuel additive.*

**Note:** *Do not blend used engine oil with diesel fuel under any circumstances. Blending used oil with the fuel will significantly increase your vehicle's exhaust emissions and reduce engine life due to increased internal wear.*



Using low sulfur diesel fuel (16–500 ppm) or high sulfur diesel fuel (greater than 500 ppm) in your diesel engine will cause certain emission components to malfunction which may also cause the service engine soon light to illuminate indicating an emissions-related concern.

Diesel fuel is adjusted seasonally for cold temperature. For best results at temperatures below 19°F (-7°C), it is recommended to use a diesel fuel which has been seasonally adjusted for the ambient conditions.

### Fuel Requirements - Choosing The Right Fuel: Vehicles Operated Where Ultra Low Sulfur Diesel Fuel Is Not Required

For the engine to operate reliably on low-sulfur or high-sulfur diesel fuel, the engine must be a factory built high-sulfur engine (available as a dealer order option for select markets) or an ultra low sulfur diesel fuel configured engine that has been retrofitted for high-sulfur diesel fuel using Ford Motor Company dealer service parts. Failure to use retrofit components other than those available through your authorized dealer will result in coolant system damage, engine overheating, selective catalyst reduction system or diesel particulate filter damage and possible base engine damage.

Use only a diesel engine configured for use with high sulfur diesel fuel in markets with diesel fuel that has sulfur content greater than 15 ppm. Using low sulfur diesel fuel (16–500 ppm) or high sulfur diesel fuel (greater than 500 ppm) in a diesel engine designed to use only Ultra Low Sulfur Diesel fuel may result in damage to engine emission control devices and the aftertreatment system, potentially rendering the vehicle inoperable.

# Fuel and Refueling

Vehicles with engines configured for use with high sulfur diesel fuel are only available for sale in countries where ultra low sulfur diesel fuel is generally not available or mandated by the government. Vehicles originally sold in an ultra low sulfur diesel fuel market that are subsequently exported to non- ultra low sulfur diesel fuel markets will need to be retrofitted (at the customer's expense using Ford authorized dealer service parts) in order to be reliably operated on non- ultra low sulfur diesel fuel.

## Biodiesel

### WARNING



Do not mix diesel with gasoline, gasohol or alcohol. This could cause an explosion.

**Note:** *Do not use home heating oil, agricultural fuel, raw fats and oils, waste cooking greases, biodiesel fuels greater than 20% or any diesel fuel not intended for highway use. Red dye is used to identify fuels intended for agricultural and non-highway use. Damage to the fuel injection system, engine and exhaust catalyst can occur if an improper fuel is used.*

You may operate your vehicle on diesel fuels containing up to 20% biodiesel, also known as B20.

Biodiesel fuel is a chemically converted product from renewable fuel sources, such as vegetable oils, animal fats and waste cooking greases.

To help achieve acceptable engine performance and durability when using biodiesel in your vehicle:

- Confirm the biodiesel content of the fuel to be B20 (20% biodiesel) or less
- Only use biodiesel fuel of good quality that complies with industry standards

- Follow the recommended service maintenance intervals. See **Scheduled Maintenance** (page 581).
- Do not store biodiesel fuel in the fuel tank for more than 1 month
- Consider changing brands or reducing biodiesel content if you have cold temperature fuel gelling issues or a frequent LOW FUEL PRESSURE message appearing
- Do NOT use raw oils, fats or waste cooking greases

Use of biodiesel in concentrations greater than 20% may cause damage to your vehicle, including engine and/or exhaust after-treatment hardware (exhaust catalyst and particulate filter) failures. Concentrations greater than 20% can also cause fuel filter restrictions that may result in a lack of power or damage to fuel system components, including fuel pump and fuel injector failures.

SAE 5W-40 or SAE 15W-40 oil is recommended for fuels with greater than 5% biodiesel (B5). Refer to the Special operating conditions section under the Schedule Maintenance chapter for more information about oil change intervals and other maintenance when operating on biodiesel.

Look for a label on the fuel pump to confirm the amount of biodiesel contained in a diesel fuel. Biodiesel content is often indicated with the letter B followed by the percent of biodiesel in the fuel. For example, B20 indicates a fuel containing 20% biodiesel. Ask the service station attendant to confirm the biodiesel content of a diesel fuel if you do not see a label on the fuel pump.

# Fuel and Refueling

Biodiesel fuels degrade more easily than diesel fuels not containing biodiesel and should not be stored in the fuel tank for more than 1 month. If you plan to park or store your vehicle for more than 1 month, then you should empty your vehicle fuel tank of biodiesel fuel. You should fill the tank with a pure petroleum-based diesel fuel and run your vehicle for a minimum of 30 minutes.

**Note:** *Degraded or oxidized biodiesel can damage fuel system seals and plastics and corrode steel parts.*

During cold weather, if you have problems operating on biodiesel, you may need to use a diesel fuel with lower biodiesel content, try another brand, or discontinue the use of biodiesel.

## Diesel Fuel Additives

It should not be necessary to add any aftermarket additives to your fuel if you use a high quality diesel fuel that conforms to ASTM industry specifications. Aftermarket additives can damage the fuel injector system or engine.

Use Motorcraft® cetane booster or an equivalent cetane booster additive if you suspect fuel has low cetane. Use Motorcraft® anti-gel & performance improver or an equivalent additive if there is fuel gelling.

Do not use alcohol-based additives to improve cetane quality, to prevent fuel gelling or any other use. The use of alcohol additives may result in damage to the fuel injectors and system. See **Capacities and Specifications** (page 432).

The Vehicle Warranty may not cover repairs needed to correct the effects of using an aftermarket product that does not meet Ford specifications in your fuel.

## FUEL QUALITY - GASOLINE

### Choosing the Right Fuel

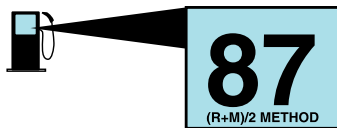

E161513

Your vehicle is designed to operate on regular unleaded gasoline with a minimum pump (R+M)/2 octane rating of 87.

Some fuel stations, particularly those in high altitude areas, offer fuels posted as regular unleaded gasoline with an octane rating below 87. We do not recommend these fuels.

For best overall vehicle and engine performance, premium fuel with an octane rating of 91 or higher is recommended. The performance gained by using premium fuel is most noticeable in hot weather as well as other conditions, for example when towing a trailer. See **Towing** (page 272).

Do not be concerned if the engine sometimes knocks lightly. However, if the engine knocks heavily while using fuel with the recommended octane rating, contact an authorized dealer to prevent any engine damage.

Do not use any fuel other than those recommended because they could lead to engine damage that will not be covered by the vehicle Warranty.

**Note:** *Use of any fuel other than those recommended can impair the emission control system and cause a loss of vehicle performance.*



# Fuel and Refueling

Do not use:

- Diesel fuel.
- Fuels containing kerosene or paraffin.
- Fuel containing more than 15% ethanol or E85 fuel.
- Fuels containing methanol.
- Fuels containing metallic-based additives, including manganese-based compounds.
- Fuels containing the octane booster additive, methylcyclopentadienyl manganese tricarbonyl (MMT).
- Leaded fuel, using leaded fuel is prohibited by law.

The use of fuels with metallic compounds such as methylcyclopentadienyl manganese tricarbonyl (commonly known as MMT), which is a manganese-based fuel additive, will impair engine performance and affect the emission control system.

We recommend Top Tier detergent gasolines to help minimize engine deposits and maintain optimal vehicle and engine performance. For additional information, refer to [www.toptiergas.com](http://www.toptiergas.com).

## RUNNING OUT OF FUEL

Avoid running out of fuel because this situation may have an adverse effect on engine components.

If you have run out of fuel:

- You may need to cycle the ignition from off to on several times after refueling to allow the fuel system to pump the fuel from the tank to the engine. On restarting, cranking time will take a few seconds longer than normal. With keyless ignition, just start the engine. Crank time will be longer than usual.
- Normally, adding 1 gal (4 L) of fuel is enough to restart the engine. If the vehicle is out of fuel and on a steep grade, more than 1 gal (4 L) may be required.

## REFUELING - GASOLINE

### WARNINGS



Fuel vapor burns violently and a fuel fire can cause severe injuries.



Read and follow all the instructions on the pump island.



Turn off your engine when you are refueling.



Do not smoke if you are near fuel or refueling your vehicle.



Keep sparks, flames and smoking materials away from fuel.



Stay outside your vehicle and do not leave the fuel pump unattended when refueling your vehicle. This is against the law in some places.



Keep children away from the fuel pump; never let children pump fuel.



Do not use personal electronic devices while refueling.



Wait at least 10 seconds before removing the fuel pump nozzle to allow any residual fuel to drain into the fuel tank.

# Fuel and Refueling

## WARNINGS



Stop refueling after the fuel pump nozzle automatically shuts off for the second time. Failure to follow this will fill the expansion space in the fuel tank and could lead to fuel overflowing.



Do not remove the fuel pump nozzle from its fully inserted position when refueling.

Use the following guidelines to avoid electrostatic charge build-up when filling an ungrounded fuel container:

- Place approved fuel container on the ground.
- Do not fill a fuel container while it is in the vehicle (including the cargo area).
- Keep the fuel pump nozzle in contact with the fuel container while filling.
- Do not use a device that would hold the fuel pump handle in the fill position.

## Fuel Filler Cap

### WARNINGS



The fuel system may be under pressure. If you hear a hissing sound near the fuel filler door, do not refuel until the sound stops. Otherwise, fuel may spray out, which could cause serious personal injury.



If you do not use the proper fuel filler cap, excessive pressure or vacuum in the fuel tank may damage the fuel system or cause the fuel cap to disengage in a collision, which may result in possible personal injury.

**Note:** *If you must replace the fuel filler cap, replace it with a fuel filler cap that is designed for your vehicle. The customer warranty may be void for any damage to the fuel tank or fuel system if the correct genuine Ford, Motorcraft or other certified fuel filler cap is not used.*

Your fuel tank filler cap has an indexed design with a 1/4th turn on and off feature. When fueling your vehicle:

1. Put your vehicle in park (P).
2. Switch the engine off.
3. Carefully turn the filler cap counterclockwise until it spins off.
4. Pull to remove the cap from the fuel filler pipe.
5. To install the cap, align the tabs on the cap with the notches on the filler pipe.
6. Turn the filler cap clockwise 1/4 of a turn clockwise until it clicks at least once.

If the Check Fuel Cap light or a Check Fuel Cap message appears in the instrument cluster and stays on after you start the engine, you may not have installed the fuel filler properly.

If the fuel cap light remains on, at the next opportunity, safely pull off of the road, remove the fuel filler cap, align the cap properly and reinstall it. The check fuel cap light or Check fuel cap message may not reset immediately. It may take several driving cycles for the indicators to turn off. A driving cycle consists of an engine start-up (after four or more hours with the engine off) followed by normal city and highway driving.

## REFUELING - DIESEL

### WARNINGS



Read and follow all the instructions on the pump island.



Stay outside your vehicle and do not leave the fuel pump unattended when refueling your vehicle.



Keep children away from the fuel pump. Never let children pump fuel.

# Fuel and Refueling

## WARNINGS



Wait at least 10 seconds before removing the fuel pump nozzle to allow any residual fuel to drain into the fuel tank.



Do not remove the fuel pump nozzle from its fully inserted position when refueling.



When refueling always shut the engine off and never allow sparks or open flames near the fuel tank filler valve. Never smoke or use a cell phone while refueling. Fuel vapor is extremely hazardous under certain conditions. Avoid inhaling excess fumes.



Stop refueling after the fuel pump nozzle automatically shuts off for the second time. Failure to follow this will fill the expansion space in the fuel tank and could lead to fuel overflowing.



The fuel system may be under pressure. If the fuel filler cap is venting vapor or if you hear a hissing sound, wait until it stops before completely removing the fuel filler cap. Otherwise, fuel may spray out and injure you or others.



If you do not use the proper fuel filler cap, excessive pressure or vacuum in the fuel tank may damage the fuel system or cause the fuel cap to disengage in a collision, which may result in possible personal injury.

**Note:** *If you must replace the fuel filler cap, replace it with a fuel filler cap designed for your vehicle. The vehicle Warranty may be void for any damage to the fuel tank or fuel system if the correct genuine Ford or Motorcraft® fuel filler cap is not used.*

## Fueling Tips

If air is allowed to enter the fuel system the engine automatically purges any trapped air. To purge the air sooner: prior to engine start, prime the system by turning the key to on for 30 seconds then to off. Repeat this several times. The engine may run rough and produce white smoke while air is in the system. This is normal.

Use only clean, approved containers that will prevent the entry of dirt or water whenever you store diesel fuel.

Diesel fuel must not be stored in a galvanized container. The fuel will dissolve the zinc in the galvanized container. The zinc will then remain in the fuel. If you run the contaminated fuel through the engine, the zinc will deposit in the fuel injectors causing expensive-to-repair damage.

## Diesel fuel dispensing nozzle fill rate

Your vehicle has a fuel fill pipe that is able to accept fuel up to 20 gal (76 L) per minute from an 1.2 in (30 mm) fuel-dispensing nozzle. Pumping fuel at greater flow rates may result in premature nozzle shut-off or spit back.

Truck stops have pumps and nozzles designed for larger, heavy-duty trucks. When refueling at truck stops: if the nozzle shuts off repeatedly when refueling, wait 5–10 seconds; then use a slower rate of flow, do not depress the nozzle trigger as far.

## Refueling

When fueling your vehicle do the following:

1. Fully open the fuel tank filler door until it engages and remove the fuel tank filler cap. The fuel tank filler cap has an indexed design with a 1/4 turn on/off feature. Carefully turn the filler cap counterclockwise until it spins off.

## Fuel and Refueling

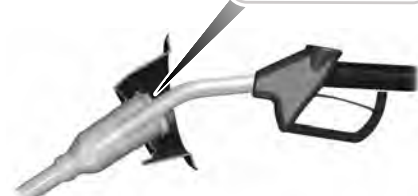
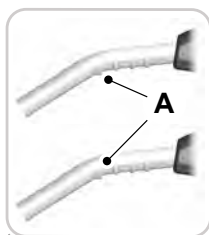

E139202

2. Insert the fuel pump nozzle up to the first notch on the nozzle A. Keep it resting on the cover of the fuel tank filler pipe opening.

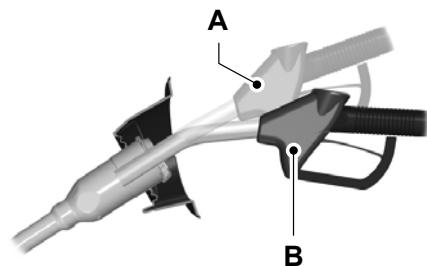

E139203

3. Hold the fuel pump nozzle in the lower position B when refueling. Holding the fuel pump nozzle in the higher position A may affect the flow of fuel and shut off the fuel pump nozzle before the fuel tank is full.



E119081

4. Slightly raise the fuel pump nozzle and then slowly remove it.
5. Replace the fuel tank filler cap and close the fuel tank filler door.

**Note:** Do not attempt to start the engine if you have filled the fuel tank with incorrect fuel. Incorrect fuel use can cause damage not covered by the vehicle Warranty. Have your vehicle checked immediately.

### Dual Fuel Tanks (If Equipped)

Your vehicle may have a dual fuel tank delivery system which operates independently and automatically. The fuel pump in the front fuel tank delivers fuel to the engine. When the fuel level in the front fuel tank drops below three quarter full, fuel automatically transfers from the rear fuel tank to the front fuel tank. Whenever there is fuel in the rear fuel tank, the front fuel tank level remains between half and three quarter full.

**Note:** If your vehicle runs out of fuel, you must add fuel to the front fuel tank to restart the engine.

### FUEL CONSUMPTION

The advertised capacity is the maximum amount of fuel that you can add to the fuel tank after running out of fuel. Included in the advertised capacity is an empty reserve. The empty reserve is an unspecified amount of fuel that remains in the fuel tank when the fuel gauge indicates empty.

# Fuel and Refueling

---

**Note:** *The amount of fuel in the empty reserve varies and should not be relied upon to increase driving range.*

## Fuel Economy

Your vehicle calculates fuel economy figures through the trip computer average fuel function. See **General Information** (page 113).

The first 1,000 mi (1,500 km) of driving is the break-in period of the engine. A more accurate measurement is obtained after 2,000 mi (3,000 km).

## Impacting Fuel Economy

- Incorrect tire inflation pressures. See **Towing a Trailer** (page 272).
- Fully loading your vehicle.
- Carrying unnecessary weight.
- Adding certain accessories to your vehicle such as bug deflectors, rollbars or light bars, running boards and ski racks.
- Using fuel blended with alcohol. See **Fuel Quality** (page 186).
- Fuel economy may decrease with lower temperatures.
- Fuel economy may decrease when driving short distances.
- You may get better fuel economy when driving on flat terrain than when driving on hilly terrain.

# Engine Emission Control

## EMISSION LAW

### WARNING



Do not remove or alter the original equipment floor covering or insulation between it and the metal floor of the vehicle. The floor covering and insulation protect occupants of the vehicle from the engine and exhaust system heat and noise. On vehicles with no original equipment floor covering insulation, do not carry passengers in a manner that permits prolonged skin contact with the metal floor. Failure to follow these instructions may result in fire or personal injury.

U.S. federal laws and certain state laws prohibit removing or rendering inoperative emission control system components. Similar federal or provincial laws may apply in Canada. We do not approve of any vehicle modification without first determining applicable laws.



Tampering with emissions control systems including related sensors or the Diesel Exhaust Fluid system can result in reduced engine power and the illumination of the service engine soon light.

## Tampering With a Noise Control System

Federal laws prohibit the following acts:

- Removal or rendering inoperative by any person other than for purposes of maintenance.
- Repair or replacement of any device or element of the design incorporated into a new vehicle for the purpose of noise control prior to its sale or delivery to the ultimate purchaser or while it is in use.
- The use of the vehicle after any person removes or renders inoperative any device or element of the design.

The U.S. Environmental Protection Agency may presume to constitute tampering as follows:

- Removal of hood blanket, fender apron absorbers, fender apron barriers, underbody noise shields or acoustically absorptive material.
- Tampering or rendering inoperative the engine speed governor, to allow engine speed to exceed manufacturer specifications.

If the engine does not start, runs rough, experiences a decrease in engine performance, experiences excess fuel consumption or produces excessive exhaust smoke, check for the following:

- A plugged or disconnected air inlet system hose.
- A plugged engine air filter element.
- Water in the fuel filter and water separator.
- A clogged fuel filter.
- Contaminated fuel.
- Air in the fuel system, due to loose connections.
- An open or pinched sensor hose.
- Incorrect engine oil level.

# Engine Emission Control

- Incorrect fuel for climatic conditions.
- Incorrect engine oil viscosity for climactic conditions.

**Note:** *Some vehicles have a lifetime fuel filter that is integrated with the fuel tank. Regular maintenance or replacement is not needed.*

**Note:** *If these checks do not help you correct the concern, have your vehicle checked as soon as possible.*

## Noise Emissions Warranty, Prohibited Tampering Acts and Maintenance

On January 1, 1978, Federal regulation became effective governing the noise emission on trucks over 10,000 lb (4,536 kg) Gross Vehicle Weight Rating (GVWR). The preceding statements concerning prohibited tampering acts and maintenance, and the noise warranty found in the Warranty Guide, are applicable to complete chassis cabs over 10,000 lb (4,536 kg) GVWR.

## CATALYTIC CONVERTER

### WARNINGS



Do not park, idle or drive your vehicle on dry grass or other dry ground cover. The emission system heats up the engine compartment and exhaust system, creating the risk of fire.



The normal operating temperature of the exhaust system is very high. Never work around or attempt to repair any part of the exhaust system until it has cooled. Use special care when working around the catalytic converter. The catalytic converter heats up to a very high temperature after only a short period of engine operation and stays hot after the engine is switched off.

### WARNINGS



Exhaust leaks may result in entry of harmful and potentially lethal fumes into the passenger compartment. If you smell exhaust fumes inside your vehicle, have your vehicle inspected immediately. Do not drive if you smell exhaust fumes.

Your vehicle has various emission control components and a catalytic converter that enables it to comply with applicable exhaust emission standards.

To make sure that the catalytic converter and other emission control components continue to work properly:

- Do not crank the engine for more than 10 seconds at a time.
- Do not run the engine with a spark plug lead disconnected.
- Do not push-start or tow-start your vehicle. Use booster cables. See **Jump Starting the Vehicle** (page 305).
- Use only the specified fuel listed.
- Do not switch the ignition off when your vehicle is moving.
- Avoid running out of fuel.
- Have the items listed in scheduled maintenance information performed according to the specified schedule.

**Note:** *Resulting component damage may not be covered by the vehicle Warranty.*

The scheduled maintenance items listed in scheduled maintenance information are essential to the life and performance of your vehicle and to its emissions system.

If you use anything other than Ford, Motorcraft or Ford-authorized parts for maintenance replacements or for service of components affecting emission control, such non-Ford parts should be equivalent to genuine Ford Motor Company parts in performance and durability.

# Engine Emission Control

Illumination of the service engine soon indicator, charging system warning light or the temperature warning light, fluid leaks, strange odors, smoke or loss of engine power could indicate that the emission control system is not working properly.

An improperly operating or damaged exhaust system may allow exhaust to enter the vehicle. Have a damaged or improperly operating exhaust system inspected and repaired immediately.

Do not make any unauthorized changes to your vehicle or engine. By law, vehicle owners and anyone who manufactures, repairs, services, sells, leases, trades vehicles, or supervises a fleet of vehicles are not permitted to intentionally remove an emission control device or prevent it from working. Information about your vehicle's emission system is on the Vehicle Emission Control Information Decal located on or near the engine. This decal also lists engine displacement.

Please consult your warranty information for complete details.

## On-Board Diagnostics (OBD-II)

Your vehicle has a computer known as the on-board diagnostics system (OBD-II) that monitors the engine's emission control system. The system protects the environment by making sure that your vehicle continues to meet government emission standards. The OBD-II system also assists a service technician in properly servicing your vehicle.



When the service engine soon indicator illuminates, the OBD-II system has detected a malfunction. Temporary malfunctions may cause the service engine soon indicator to illuminate. Examples are:

1. Your vehicle has run out of fuel—the engine may misfire or run poorly.
2. Poor fuel quality or water in the fuel—the engine may misfire or run poorly.
3. The fuel fill inlet may not have closed properly. See **Refueling** (page 190).
4. Driving through deep water—the electrical system may be wet.

You can correct these temporary malfunctions by filling the fuel tank with good quality fuel, properly closing the fuel fill inlet or letting the electrical system dry out. After three driving cycles without these or any other temporary malfunctions present, the service engine soon indicator should stay off the next time you start the engine. A driving cycle consists of a cold engine startup followed by mixed city and highway driving. No additional vehicle service is required.

If the service engine soon indicator remains on, have your vehicle serviced at the first available opportunity. Although some malfunctions detected by the OBD-II may not have symptoms that are apparent, continued driving with the service engine soon indicator on can result in increased emissions, lower fuel economy, reduced engine and transmission smoothness and lead to more costly repairs.

## Readiness for Inspection and Maintenance (I/M) Testing

Some state and provincial and local governments may have Inspection/Maintenance (I/M) programs to inspect the emission control equipment on your vehicle. Failure to pass this inspection could prevent you from getting a vehicle registration.



If the service engine soon indicator is on or the bulb does not work, your vehicle may need service. See On-Board Diagnostics.



# Engine Emission Control

Your vehicle may not pass the I/M test if the service engine soon indicator is on or not working properly (bulb is burned out), or if the OBD-II system has determined that some of the emission control systems have not been properly checked. In this case, the vehicle is not ready for I/M testing.

If the vehicle's engine or transmission has just been serviced, or the battery has recently run down or been replaced, the OBD-II system may indicate that the vehicle is not ready for I/M testing. To determine if the vehicle is ready for I/M testing, turn the ignition key to the on position for 15 seconds without cranking the engine. If the service engine soon indicator blinks eight times, it means that the vehicle is not ready for I/M testing; if the service engine soon indicator stays on solid, it means that your vehicle is ready for I/M testing.

The OBD-II system checks the emission control system during normal driving. A complete check may take several days.

If the vehicle is not ready for I/M testing, you can perform the following driving cycle consisting of mixed city and highway driving:

1. 15 minutes of steady driving on an expressway or highway followed by 20 minutes of stop-and-go driving with at least four 30-second idle periods.
2. Allow your vehicle to sit for at least eight hours with the ignition off. Then, start the vehicle and complete the above driving cycle. The vehicle must warm up to its normal operating temperature. Once started, do not turn off the vehicle until the above driving cycle is complete.

If the vehicle is still not ready for I/M testing, you need to repeat the above driving cycle.

## SELECTIVE CATALYTIC REDUCTANT SYSTEM-DIESEL

Your vehicle may have a selective catalytic reduction system. The system helps reduce emission levels of oxides of nitrogen from the exhaust system. The system automatically injects diesel exhaust fluid into the exhaust system to enable correct selective catalytic reduction system function.

**Note:** *Selective catalytic reduction systems are not fitted to vehicles in markets where only high-sulfur diesel fuel is available.*

### Diesel Exhaust Fluid Level

In order for the system to operate correctly you must maintain the diesel exhaust fluid level.

A warning message appears in the information display when the diesel exhaust fluid level is low. If a warning message appears, refill the diesel exhaust fluid tank as soon as possible. See **Information Messages** (page 129).

### Filling the Diesel Exhaust Fluid Tank

#### WARNINGS



Keep diesel exhaust fluid out of reach of children. Avoid contact with skin, eyes or clothing. In case of contact with your eyes, flush immediately with water and get prompt medical attention. In case of contact with your skin, clean immediately with soap and water. If you swallow any diesel exhaust fluid, drink plenty of water, call a physician immediately.

# Engine Emission Control

## WARNINGS



Only refill the diesel exhaust fluid tank in a well ventilated area. When you remove the diesel exhaust fluid tank filler cap or a diesel exhaust fluid container cap, ammonia vapors may escape. Ammonia vapors can be irritating to skin, eyes and mucous membranes. Inhaling ammonia vapors can cause burning to the eyes, throat and nose and cause coughing and watery eyes.

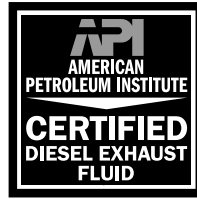

E163354

Only use diesel exhaust fluid that is certified by the American Petroleum Institute (API). Non-certified diesel exhaust fluid use can cause damage not covered by the vehicle Warranty.

**Note:** Do not put diesel exhaust fluid in the fuel tank. This can cause damage not covered by the vehicle Warranty.

You can purchase diesel exhaust fluid at an authorized dealer, most highway truck stops or you can contact roadside assistance for help in finding a retailer that sells diesel exhaust fluid. In addition, there is a government website to help you find the nearest location to purchase diesel exhaust fluid:  
<http://www.discoverdef.com>.

### Filling the Diesel Exhaust Fluid Tank Using a Fuel Station Pump

Filling the diesel exhaust fluid tank using a nozzle is similar to fuel fill. The nozzle shuts off automatically when the tank is full.

### Filling the Diesel Exhaust Fluid Tank Using a Container

The following procedure applies to Motorcraft diesel exhaust fluid or similar fluid containers. Always follow the manufacturer's instructions.

1. Remove the diesel exhaust fluid container cap. Place the spout on to the container and tighten it until you feel a strong resistance.

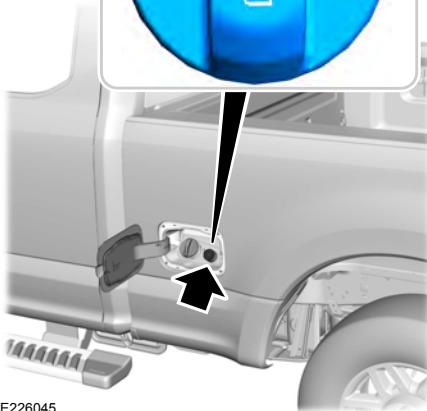

E226045

The diesel exhaust fluid tank has a blue filler cap. The tank is behind the left-hand front wheel. Fill the tank using a fluid pump at a diesel exhaust fluid filling station or a diesel exhaust fluid container. We recommend Motorcraft® diesel exhaust fluid. See **Capacities and Specifications** (page 427).

# Engine Emission Control

2. Remove the diesel exhaust fluid tank filler cap.
3. Insert the spout in to the filler neck until the seal on the spout seats on to the filler neck. Pour the fluid in to the tank. When the tank is full the fluid will stop flowing automatically.
4. Return the container to the vertical position slightly below the diesel exhaust fluid filler neck. Allow any fluid remaining in the spout to drain back in to the container.
5. Remove the spout from the diesel exhaust fluid filler neck. Replace the diesel exhaust fluid tank cap.
6. Remove the spout from the diesel exhaust fluid container and replace the cap.

**Note:** *If there is diesel exhaust fluid left in the container retain it for later use. The spout is re-useable. Wash the spout with clean water prior to storage. Do not use the diesel exhaust fluid spout with any other fluid.*

## Filling the Diesel Exhaust Fluid Tank in Cold Climates

Diesel exhaust fluid may freeze if the ambient temperature is below 12°F (-11°C). Your vehicle has a preheating system which allows diesel exhaust fluid to operate below 12°F (-11°C). If you do not use your vehicle for an extended period when the ambient temperature is below 12°F (-11°C), the fluid in the tank may freeze. If the tank is overfilled and the fluid freezes it may damage the tank. This is not covered by the vehicle warranty.

## Diesel Exhaust Fluid Warning Messages and Vehicle Operations

### WARNINGS



Diesel exhaust fluid must be refilled when low or replaced when contaminated or your vehicle speed becomes limited to 50 mph (80 km/h). In these conditions, drive with caution and refill diesel exhaust fluid immediately. If the diesel exhaust fluid becomes empty or contaminated and fluid is not replaced, your vehicle becomes limited to engine idle only once stopped. In these conditions, be cautious where you stop your vehicle because you may not be able to drive long distances or maintain highway speeds until you refill or replace the diesel exhaust fluid.



Tampering with or disabling the selective catalytic reduction system results in severe vehicle performance limitation including eventual speed limiting to 5 mph (8 km/h).

The information display shows a series of messages about the amount of diesel exhaust fluid available. A systems check displays messages indicating the amount of diesel exhaust fluid available or displays a warning message indicating the approximate distance remaining as the fluid in the diesel exhaust fluid tank nears empty. See **Information Messages** (page 129).



As the diesel exhaust fluid level nears empty, the warning symbol displays and a series of tones and messages starting at 500 mi (800 km) remaining before diesel exhaust fluid is depleted. The warning symbol and messages continue until you refill the diesel exhaust fluid tank.

# Engine Emission Control

---

Continued driving without refilling results in the following actions as required by the California Air Resources Board (CARB) and the U.S. Environmental Protection Agency (EPA):

- Within a preset distance to empty, speed is limited upon vehicle restart. Prior to this occurring a message appears in the information display.
- Further vehicle operation without refilling the diesel exhaust fluid tank causes the engine to enter an idle-only condition. This only occurs upon vehicle refueling or at an extended idle. A message indicates the required actions to resume normal operation. It is required to add a minimum of 1.0 gal (3.8 L) of diesel exhaust fluid to the tank to exit the idle-only condition, but your vehicle is still in the speed-limiting mode until you refill the tank completely.

**Note:** *For either vehicle speed limiting or idle-only condition, normal vehicle operation resumes when you refill the diesel exhaust fluid tank.*

**Note:** *When filling the diesel exhaust fluid tank from empty, there may be a short delay before detecting the increased level of fluid. The increased level detection must occur before your vehicle returns to full power.*

## Diesel Exhaust Fluid Guidelines and Information

- Use only diesel exhaust fluid that carries the American Petroleum Institute (API) certified diesel exhaust fluid trademark or ISO 22241.
- Do not put diesel exhaust fluid in the diesel fuel tank.
- Do not overfill the diesel exhaust fluid tank.
- Diesel exhaust fluid is corrosive.
- Do not re-use the diesel exhaust fluid container once it is emptied.
- Avoid spilling diesel exhaust fluid on painted surfaces, carpeting or plastic components. Immediately wipe away any diesel exhaust fluid that has spilled with a damp cloth and water. If it has already crystallized, use warm water and a sponge.
- Store diesel exhaust fluid out of direct sunlight and in temperatures between 23°F (-5°C) and 68°F (20°C).
- Diesel exhaust fluid freezes below 12°F (-11°C).
- Do not store the diesel exhaust fluid bottle in your vehicle. If it leaks it could cause damage to interior components or release an ammonia odor inside your vehicle.
- Diesel exhaust fluid is non-flammable, non-toxic, colorless and water-soluble liquid.
- The system has a diesel exhaust fluid quality sensor. Dilution of diesel exhaust fluid or use of any other liquid in the SCR system leads to a diesel exhaust fluid system fault, eventually leading to the vehicle only operating in idle-only mode.
- Do not dilute diesel exhaust fluid with water or any other liquid.
- An ammonia odor may be smelled when the cap is removed or during refill. Refill diesel exhaust fluid in a well ventilated area.

# Engine Emission Control

## Typical Diesel Exhaust Fluid Usage When Using the Power Take Off (PTO)

Continuous PTO use—Minimal PTO use
0–7,800 mi (0–12,550 km)

## Contaminated Diesel Exhaust Fluid or Inoperative Selective Catalytic Reduction System

Selective catalytic reduction systems are sensitive to contamination of the diesel exhaust fluid. Maintaining the purity of the fluid is important to avoid system malfunctions. If you remove or drain the diesel exhaust fluid tank, do not use the same fluid to refill the tank. The system has a sensor to monitor fluid quality.



A warning lamp illuminates and a message appears in the information display if the system becomes contaminated or inoperative.

Continued driving without replacing diesel exhaust fluid or having the selective catalytic reduction system repaired results in the following actions as required by the California Air Resources Board (CARB) and U.S. Environmental Protection Agency (EPA):

- Within a preset distance to empty, speed is limited upon vehicle restart. Prior to this occurring a message appears in the information display.
- Further vehicle operation without replacing contaminated diesel exhaust fluid causes the engine to enter an idle-only condition. This only occurs upon vehicle refueling, vehicle idling in park for 1 hour, or engine shutdown for 10 minutes or more and is indicated by a message in the information display indicating required actions to resume normal operation.

**Note:** For vehicle speed limiting or idle-only condition, normal vehicle operation resumes when you repair the contaminated system. To service a contaminated or inoperative system, see an authorized dealer.

## DIESEL PARTICULATE FILTER

The filter forms part of the emissions reduction system on your vehicle. It filters harmful diesel particulates (soot) from the exhaust gas.

### Regeneration

#### WARNING



Do not park or idle your vehicle over dry leaves, dry grass or other combustible materials. The

regeneration process creates very high exhaust gas temperatures and the exhaust will radiate a considerable amount of heat during and after regeneration and after you have switched the engine off. This is a potential fire hazard.

**Note:** Avoid running out of fuel.

**Note:** During regeneration at low speed or engine idle, you may smell a hot metallic odor and could notice a clicking metallic sound. This is due to high temperatures reached during regeneration and is normal.

**Note:** Changes in the engine or exhaust sound may be heard during the regeneration process.

The diesel particulate filter on your vehicle requires periodic regeneration to maintain its correct function. Your vehicle will carry out this process automatically.

# Engine Emission Control

If your journeys meet one of the following conditions:

- You drive only short distances.
- You frequently switch the ignition on and off.
- Your journeys contain a high level of acceleration and deceleration.

You must carry out occasional trips with the following conditions to assist the regeneration process:

- Drive your vehicle in more favorable conditions, which you will find at higher vehicle speeds in normal driving, on a main road or freeway for a minimum of 20 minutes. This drive may include short stops that will not affect the regeneration process.
- Avoid prolonged idling and always observe speed limits and road conditions.
- Do not switch the ignition off.
- Select a suitable gear to ideally maintain engine speed between 1500 and 3000 RPM.

## Oxidation Catalytic Converter and Diesel Particulate Filter System (if

Equipped)

### WARNING



The normal operating temperature of the exhaust system is very high. Never work around or attempt to repair any part of the exhaust system until it has cooled. Use special care when working around the diesel oxidation catalytic converter or the diesel particulate filter. The diesel oxidation catalytic converter and the diesel particulate filter heat up to very high temperatures after only a short period of engine operation and remain hot after you switch the engine off.

Your vehicle has a diesel particulate filter. The diesel particulate filter is an inline filter in the exhaust system that reduces carbon emissions by trapping exhaust particles before they reach the tailpipe. The diesel particulate filter looks similar to a traditional exhaust catalyst and is part of the exhaust system under your vehicle. The filter couples to a diesel oxidation catalyst that reduces the amount of harmful exhaust emitted from the tailpipe. As soot gathers in the system, it begins to restrict the filter. The system must periodically clean the soot that gathers inside the filter. This is carried out in two ways, passive regeneration and active regeneration. Both methods occur automatically and require no actions from the driver. During either one of these regeneration methods, you may notice a change in exhaust tone. At certain times, the information display shows various messages related to the diesel particulate filter. See **Information Messages** (page I29).

## Diesel Particulate Filter Maintenance

You must properly maintain your vehicle's diesel particulate filter in order for it to function properly.

Do not disregard maintenance messages that appear in the information display. Failure to follow the instructions of an information message may degrade vehicle performance and could lead to engine damage that may not be covered by the vehicle Warranty.

Failure to perform active or operator commanded regeneration when instructed could result in a clogged diesel particulate filter. If the diesel particulate filter fills beyond the regeneration threshold, your vehicle disables the ability for active and operator commanded regeneration. This could result in irreversible damage to the diesel particulate filter requiring replacement that may not be covered by the vehicle Warranty.

# Engine Emission Control

## Passive Regeneration

In passive regeneration, the exhaust system temperature and constituents automatically clean the filter by oxidizing the soot. Cleaning automatically occurs during normal vehicle operating conditions due to driving patterns.

## Active Regeneration

Once the diesel particulate filter is full of exhaust particles, the engine control module commands the exhaust system to clean the filter through active regeneration. Active regeneration requires the engine computer to raise the exhaust temperature to eliminate the particles. During cleaning, the particles convert to harmless gasses. Once cleaned the diesel particulate filter continues trapping exhaust particles.

The regeneration process operates more efficiently when you drive your vehicle at a constant speed above 30 mph (48 km/h) and at a steady engine speed for approximately 20 minutes. The frequency and duration of regeneration fluctuates by how you drive your vehicle, outside air temperature and altitude. For most driving, regeneration frequency varies from 100–500 mi (160–805 km) between occurrences and each occurrence lasts 9–35 minutes. You can usually reduce the duration of regeneration if you maintain a constant speed above 30 mph (48 km/h).

When the engine control module detects that the diesel particulate filter is nearly full of particulates and you are not operating your vehicle in a manner to allow effective automatic regeneration, messages appear in the information display as a reminder for you to drive your vehicle in order to clean the diesel particulate filter. If you drive your vehicle in a manner to allow effective automatic regeneration, the information display

shows a cleaning exhaust filter message, which is the normal regeneration process. You can also choose operator commanded regeneration to clean the exhaust system at this point. See **Information Messages** (page 129).

If you are not able to drive in a manner that allows effective automatic active regeneration or you choose to perform regeneration of the diesel particulate filter while at idle, then operator commanded regeneration would need to be performed.

## Operator Commanded Regeneration (If Equipped)

If your vehicle is operated with significant stationary operation, low speed drive cycles less than 25 mph (40 km/h), short drive cycles, a drive time is less than 10 – 15 minutes or the vehicle does not fully warm up, passive and active regeneration may not sufficiently clean the diesel particulate filter system. Operator commanded regeneration allows you to manually start regeneration of the diesel particulate filter at idle to clean the filter. If you are not sure whether your vehicle has this feature, contact an authorized dealer.

## When to Carry Out Operator Commanded Regeneration

You can use the operator commanded regeneration feature when a message appears in the information display and you are not able to drive in a manner that allows effective automatic active regeneration or if you choose to manually start the regeneration of the diesel particulate filter manually while the vehicle is idle. See **Information Messages** (page 129).

# Engine Emission Control

## Operator Commanded Regeneration Precautions and Safe Exhaust Position

### WARNINGS



Do not park or idle your vehicle over dry leaves, dry grass or other combustible materials. The regeneration process creates very high exhaust gas temperatures and the exhaust will radiate a considerable amount of heat during and after regeneration and after you have switched the engine off. This is a potential fire hazard.



Stay clear of the exhaust tailpipe during regeneration. Hot exhaust gases can burn you badly.

Make sure that the louvers located at the tip of the exhaust are clear of any obstructions as they are used to introduce fresh air into the tailpipe to cool the exhaust gases as they leave the exhaust system.

Before you start operator commanded regeneration, do the following:

- Shift into park (P) and apply the parking brake, on stable, level ground.
- Park your vehicle outside of any structure.
- Park your vehicle 10–15 ft (3–5 m) away from any obstructions and away from materials that can easily combust or melt, for example paper, leaves, petroleum products, fuels, plastics and other dry organic material.
- Make sure there is a minimum of 1/8 tank of fuel.
- Make sure all fluids are at proper levels.

## How to Start Operator Commanded Regeneration

### WARNING



Stay clear of the exhaust tailpipe during regeneration. Hot exhaust gases can burn you badly.

**Note:** You cannot use the operator commanded regeneration until the diesel particulate filter load percentage has reached 100%. The diesel particulate filter load percentage fluctuates up and down when driving your vehicle due to active and passive regenerations.

**Note:** During the use of operator commanded regeneration, you may observe a light amount of white smoke. This is normal.



You may not be able to use operator commanded regeneration if the service engine soon warning lamp appears in the information display

### Information Display Procedure

Start with your vehicle engine and when it has reached the normal operating temperature, press the information display control button on the steering wheel. See **Information Display Control** (page 85). If a message advising that the exhaust filter is full appears in the information display, press the **OK** button as instructed. Answer yes to this prompt and then follow the next prompts regarding the exhaust position required to initiate operator commanded regeneration. Be sure to understand each prompt. If you are not sure what is being asked by each prompt, contact an authorized dealer. The display confirms the operation has started and when it has finished.



# Engine Emission Control

If the diesel particulate filter is near or at saturation, a message requesting permission to initiate filter cleaning appears in the information display. See **Information Messages** (page 129). Answer yes to this prompt and then follow the next prompts regarding exhaust position required to initiate operator commanded regeneration. Be sure to understand each prompt. If you are not sure what is being asked by each prompt, contact an authorized dealer. The display confirms the operation has started and when it has finished. You can also drive to clean the filter.



When the system is at the point of oversaturation, the service engine warning lamp illuminates and a message appears in the information display. You cannot initiate filter cleaning. You must have your vehicle checked as soon as possible.

Once operator commanded regeneration starts, engine speed increases to approximately 2000 rpm and the cooling fan speed increases. You will hear a change in audible sound due to engine speed and cooling fan speed increases.

It is not necessary to open the hood on the engine compartment. Once operator commanded regeneration completes, the engine speed returns to normal idling. The exhaust system remains very hot for several minutes even after regeneration is complete. Do not reposition the vehicle over materials that could burn until the exhaust system has had sufficient time to cool. Depending on the amount of soot collected by the diesel particulate filter, ambient temperature and altitude, operator commanded regeneration lasts approximately 30 minutes.

## **Operator Commanded Regeneration with Automatic Regeneration Control (If Equipped)**

If your vehicle is operated with significant stationary operation, low speed drive cycles less than 25 mph (40 km/h), short drive cycles, drive time less than 15 minutes or the vehicle does not fully warm up, passive and active regeneration may not sufficiently clean the diesel particulate filter system. You can switch off automatic regeneration until better driving conditions are available, for example steady high speed driving. You can then switch automatic regeneration back on to clean the diesel particulate filter.

### **Switching Automatic Regeneration Control On and Off**

To switch operator commanded regeneration on and off, use the information display control on the steering wheel. See **Information Display Control** (page 85). Scroll to the exhaust cleaning message, a check in the box indicates the feature is enabled, and unchecked indicates the feature is disabled.

### **How to Interrupt or Cancel Operator Commanded Regeneration**

If you need to cancel the operator commanded regeneration, pressing the brake, accelerator or switching the engine off stops the procedure. Depending on the amount of time you allowed the operator commanded regeneration to operate, soot may not have had sufficient time to be fully eliminated, but the exhaust system and exhaust gas may still be hot. If you shut your vehicle off during operator commanded regeneration, you may notice turbo flutter. This is a normal consequence caused by shutting off a diesel engine during boosted operation and is considered normal.

# Engine Emission Control

---

## Filter Service and Maintenance

Over time, a slight amount of ash builds up in the diesel particulate filter, which is not removed during the regeneration process. The filter may need to be replaced with a new or remanufactured part at approximately 250,000 mi (400,000 km). Actual mileage varies depending on engine and vehicle operating conditions.



If filter service is required, the engine control system warning lamp illuminates in the information display.



If there are any issues with the diesel particulate filter system, the engine control system warning lamp and a service engine soon warning lamp illuminate to inform you that your vehicle requires service. Have your vehicle checked as soon as possible.



## Resonator and Tailpipe Assembly Maintenance

Aftermarket devices or modifications to the exhaust system may reduce the effectiveness of the exhaust system as well as cause damage to the exhaust system or engine. This may also degrade vehicle performance and could lead to engine damage that may not be covered by the vehicle Warranty.

# Transmission

## AUTOMATIC TRANSMISSION

### WARNINGS



Always fully apply the parking brake. Make sure you shift into park (P) for vehicles with an automatic transmission. Switch the ignition off and remove the key whenever you leave your vehicle.



When your vehicle is stationary, keep the brake pedal fully pressed when shifting gears. Failure to follow this instruction could result in personal injury, death or property damage.

**Note:** You may not be able to shift out of park (P) unless the intelligent access key is inside your vehicle.

## Understanding the Shift Positions of Your Automatic Transmission

(If Equipped)

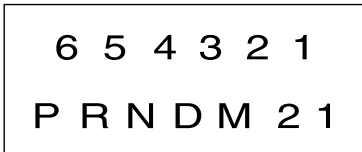

E163183

### Putting your vehicle in or out of gear:

1. Fully press down the brake pedal.
2. Move the gearshift lever into the desired gear.
3. When you are finished driving, come to a complete stop.
4. Move the gearshift lever and securely latch it in park (P).

### Park (P)

This position locks the transmission and prevents the rear wheels from turning.

### Reverse (R)

With the gearshift lever in reverse (R), your vehicle moves backward. Always come to a complete stop before shifting into and out of reverse (R).

### Neutral (N)

With the gearshift lever in neutral (N), your vehicle can be started and is free to roll. Hold the brake pedal down when in this position.

### Drive (D)

Drive (D) is the normal driving position for the best fuel economy. The drive function allows automatic upshifts and downshifts through gears one through six.

### M (Manual)

With the gearshift lever in manual (M), the driver can change gears up or down as desired. By moving the gearshift lever from drive position drive (D) to manual (M) you now have control of selecting the gear you desire using buttons on the shift lever. See Understanding your SelectShift Automatic™ transmission later in this section.

To return to normal drive (D) position, move the shift lever back from manual (M) to drive (D).

The transmission operates in gears one through six.

### Second (2)

Transmission operates in second (2) gear only. Use second (2) gear to start-up on slippery roads.

# Transmission

## First (1)

- Transmission operates in first (1) gear only.
- Provides maximum engine braking.
- Allows upshifts by moving gearshift lever.
- Does not downshift into first (1) gear at high speeds; allows for first (1) gear when vehicle reaches slower speeds.

## Forced downshifts

- Allowed in drive (D) with the tow/haul feature on or off.
- Press the accelerator to the floor.
- Allows transmission to select an appropriate gear.

## Tow/Haul Mode

### WARNING



Do not use tow/haul when the road surface is slippery. Failure to follow this instruction could result in the loss of control of your vehicle.



To activate tow/haul, press the button on the gearshift lever once. The TOW HAUL indicator light illuminates in the instrument cluster.

The tow/haul feature:

- Delays upshifts to reduce the frequency of transmission shifting.
- Provides engine braking in all forward gears, which slows your vehicle and assists you in controlling your vehicle when descending a grade.
- Depending on driving conditions and load conditions, may downshift the transmission, slow your vehicle and control your vehicle speed when descending a hill, without pressing the accelerator pedal. The amount of downshift braking provided varies based upon the amount you press the brake pedal.

The tow/haul feature improves transmission operation when towing a trailer or a heavy load. All transmission gear ranges are available when using tow/haul.

**Note:** *If your vehicle is equipped with the Adaptive Steering System, enabling the tow/haul feature adjusts the steering response. In tow/haul mode the Adaptive Steering system reduces vehicle sensitivity to steering inputs at higher vehicle speeds when maintaining the ease of parking and maneuverability at low speeds. See **Steering** (page 259).*

To deactivate the tow/haul feature and return to normal driving mode, press the button on the gearshift lever when tow/haul is active. The TOW HAUL light deactivates. Tow/haul also deactivates when you power down your vehicle.

# Transmission

## Understanding your SelectShift Automatic™ transmission (If Equipped)



E163184

Your vehicle is equipped with a SelectShift Automatic™ transmission gearshift lever. The SelectShift Automatic transmission gives you the ability to change gears up or down (without a clutch) as desired.

In order to prevent the engine from running at too low an RPM, which may cause it to stall, SelectShift still automatically make some downshifts if it has determined that you have not downshifted in time. Although SelectShift makes some downshifts for you, it still allows you to downshift at any time as long as the SelectShift determines that damage will not be caused to the engine from over-revving.

SelectShift does not automatically upshift, even if the engine is approaching the RPM limit. It must be shifted manually by pressing the + button.

**Note:** *Engine damage may occur if you maintain excessive engine revving without shifting.*

The SelectShift Automatic transmission feature has two modes: PRS and M mode.

### PRS (Progressive Range Selection)

Progressive Range Selection gives you the ability to lockout gears from the automatic shifting range. This may provide you with an improved driving experience (for example, in slippery conditions or when experiencing a steep grade).

With the gearshift lever in drive (D), press the – button to active PRS. The available and selected gears are indicated on the instrument cluster.

All available gears display with the current gear indicated. Press the – button again to lock out gears beginning with the highest gear. Example: press the – button twice to lock out 6th and 5th gears. Only the available gears display and the transmission automatically shifts between the available gears. Press the + button to unlock gears to allow the transmission to shift to higher gears. The transmission shifts automatically within the gear range you select.

### Manual (M)

Moving the gearshift lever to the manual (M) position allows you to manually select the gear you desire. Only the current gear displays. Use the buttons on the gearshift lever to manually select gears. Press the + button to upshift or the – button to downshift. Return the transmission to a different gearshift position to deactivate manual control.

### Recommended shift speeds

Upshift according to the following chart:

# Transmission

## Upshifts When Accelerating (Recommended for Best Fuel Economy)

Shift from:	Gasoline engines	Diesel engines
1 – 2	15 mph (24 km/h)	12 mph (19 km/h)
2 – 3	25 mph (40 km/h)	19 mph (31 km/h)
3 – 4	40 mph (64 km/h)	26 mph (42 km/h)
4 – 5	45 mph (72 km/h)	34 mph (55 km/h)
5 – 6	50 mph (80 km/h)	46 mph (74 km/h)

### Automatic Transmission Adaptive Learning

This feature's design is to increase durability and provide consistent shift feel over the life of your vehicle. A new vehicle or transmission may have firm shifts, soft shifts or both. This operation is normal and does not affect function or durability of the transmission. Over time, the adaptive learning process fully updates transmission operation. Additionally, whenever you disconnect the battery or install a new battery, the system must relearn the strategy.

### Brake-Shift Interlock

#### WARNINGS



When doing this procedure, you need to take the transmission out of park (P) which means your vehicle can roll freely. To avoid unwanted vehicle movement, always fully apply the parking brake prior to doing this procedure. Use wheels chocks if appropriate.



If the parking brake is fully released, but the brake warning lamp remains illuminated, the brakes may not be working properly. Have your vehicle checked as soon as possible.

**Note:** Do not drive your vehicle until you verify that the brake lamps are working.

Your vehicle is equipped with a brake-shift interlock feature that prevents the gearshift lever from moving from park (P) when the ignition is on and the brake pedal is not pressed.

If you cannot move the gearshift lever out of park (P) position with the ignition is on and the brake pedal pressed, a malfunction may have occurred. It is possible that a fuse has blown or your vehicle's brake lamps are not operating properly. See **Fuse Specification Chart** (page 317).

If the fuse is not blown and the brake lamps are working properly, the following procedure allows you to move the gearshift lever from park (P):

1. Apply the parking brake. Switch the ignition key to 1 (off), then remove the key.
2. Move the steering column to the full down and full rearward position (toward the driver's seat).
3. Remove the gearshift lever boot.

# Transmission

- Place fingers into hole where you removed the gearshift lever boot and pull top half of shroud up and forward to separate it from the lower half of the shroud. There is a hinge at the forward edge of the top shroud. Roll the top half of the shroud upward on the hinge point to clear the hazard flasher button, then pull straight rearward toward the driver's seat to remove.
- Remove the top half of the shroud.
- Remove the three fasteners under the column that secure the lower shroud half to the column.



E163185

- Pull the lock lever into the full unlocked position and remove the lower shroud cover by pulling the lever handle through the slot in the cover.
- Apply the brake. Gently lift the override disk and move the gearshift lever into neutral (N).



E163186

- Start your vehicle.

Perform Steps 4 through 8 in reverse order, making sure to engage the hinge pivots between the upper and lower halves of the shroud. Keep slight pressure in the forward direction as you rotate the halves together.

## If Your Vehicle Gets Stuck In Mud or Snow

**Note:** Do not rock your vehicle if the engine is not at normal operating temperature or damage to the transmission may occur.

**Note:** Do not rock your vehicle for more than a minute or damage to the transmission and tires may occur, or the engine may overheat.

If your vehicle is stuck in mud or snow, you may rock it out by shifting between forward and reverse gears, stopping between shifts in a steady pattern. Press lightly on the accelerator in each gear.

# Transmission

---

## **POWER TAKE-OFF (If Equipped)**

### **WARNING**



Use of auxiliary equipment that exceeds the maximum Power Take-Off (PTO) load specified in the Ford Truck Body Builders Layout Book can adversely affect the performance of the powertrain system. Refer to the Body Builders Layout Book for instructions about the appropriate installation of additional equipment.

---

Auxiliary equipment called power take-off, or PTO, is often added to the engine or transmission to operate utility equipment. Examples include a wheel-lift for tow trucks, cranes, tools for construction or tire service, and pumping fluids. PTO applications draw auxiliary horsepower from the powertrain, often while the vehicle is stationary. In this condition, there is limited cooling air flow through the radiator and around the vehicle that normally occurs when a vehicle is moving. The aftermarket PTO system installer, having the most knowledge of the final application, is responsible for determining whether additional chassis heat protection or powertrain cooling is required, and alerting the user to the safe and proper operation.

Ford Super Duty Vehicles are approved for use as a stationary (including split shaft capability) or mobile power source, within limits and operating guidelines detailed in the Ford Truck Body Builders Layout Book, found at [www.fleet.ford.com/truckbbas](http://www.fleet.ford.com/truckbbas), and through the Ford Truck Body Builders Advisory Service.



## Four-Wheel Drive (If Equipped)

### USING FOUR-WHEEL DRIVE

**Note:** For important information regarding the safe operation of this type of vehicle, see General Information in the Wheels and Tires chapter.

**Note:** Do not use 4H or 4L mode on dry, hard surfaced roads. Doing so can produce excessive noise, increase tire wear and may damage drive components. 4X4 mode is only intended for consistently slippery or loose surfaces. Use of 4L mode on these surfaces may produce some noise (such as occasional clunks), but will not damage drive components.

**Note:** If 4X4 low is selected while the vehicle is moving above 3 mph (5 km/h), the 4WD system will not perform a shift. This is normal and should be no reason for concern. Refer to Shifting to or from 4L (4X4 Low) for proper operation.

**Note:** You can switch on and switch off the electronic locking differential by pulling the 4WD control (4WD vehicles) or turning the electronic locking differential control (2WD vehicles). See **Electronic Locking Differential** (page 223).

#### Manual Shift On Stop (MSOS) 4WD system (If Equipped)

**Note:** The vehicle should not be driven in 4X4 High or 4X4 Low modes with the hub locks set to FREE as this condition may damage driveline system components.



E163187

The 4WD system is engaged or disengaged by rotating the control for both front wheel hub locks from the FREE or LOCK position, then manually engaging or disengaging the transfer case with the floor-mounted shifter. For increased fuel economy in 2WD, rotate both hub locks to the FREE position.

#### Electronic Shift-On-the-Fly (ESOF) 4WD system (If Equipped)

**Note:** If 4X4 Low is selected while the vehicle is moving above 3 mph (5 km/h), the 4WD system will not perform a shift. This is normal and should be no reason for concern. Refer to Shifting to or from 4L (4X4 Low) for proper system operation.

**Note:** Auto-manual hub locks can be manually overridden by rotating the hub lock control from AUTO to LOCK.



E163188

# Four-Wheel Drive (If Equipped)

For proper operation, make sure that each hub is fully engaged and that both hub locks are set to the same position (both set to LOCK or both set to AUTO). To engage LOCK, turn the hub locks completely clockwise; to engage AUTO, turn the hub locks completely counterclockwise.

The ESOF 4WD system:

- provides 4x4 High engagement and disengagement while the vehicle is moving.
- is operated by a rotary control located on the instrument panel that allows you select 4x2, 4x4 High or 4x4 Low operation.
- uses auto-manual hub locks that can be engaged and disengaged automatically based on the 4x4 mode selected.
- will increase fuel economy when used in the hub lock's recommended AUTO mode.

## 4WD Indicator Lights

**Note:** When a 4X4 system fault is present, the system will typically remain in whichever 4X4 mode was selected prior to the fault condition occurring. It will not default to 4X2 in all circumstances. When this warning is displayed, have your vehicle serviced by an authorized dealer.

### 4X2

**4x2**

Momentarily illuminates when 2H is selected.

### 4X4 HIGH

**4H**

Continuously illuminates when 4H is selected.

### 4X4 LOW

**4L**

Continuously illuminates when 4L is selected.

### CHECK 4X4



Displays when a 4X4 fault is present.

## Using a Manual Shift On Stop (MSOS) 4WD system (If Equipped)

**Note:** High shift efforts may be encountered when attempting to shift into and out of 4x4 modes. It is recommended to allow the vehicle to roll at a speed below 3 mph (5 km/h) when shifting between modes.



E233846

### 2H (4X2)

For general on-road driving. Sends power to the rear wheels only and should be used for street and highway driving. Provides optimal smoothness and fuel economy at high speeds

### 4H (4X4 High)

Used for extra traction such as in snow or icy roads or in off road situations. This mode is not intended for use on dry pavement.

# Four-Wheel Drive (If Equipped)

## N (Neutral)

Only used when towing the vehicle. No power to front or rear wheels.

## 4L (4X4 Low)

Uses extra gearing to provide maximum power to all four wheels at reduced speeds. Intended only for off road applications such as deep sand, steep grades or pulling heavy objects.

## Shifting between system modes

**Note:** Do not perform these operations if the rear wheels are slipping or when applying the accelerator pedal.

**Note:** Some noise may be heard as the 4x4 system shifts or engages. This is normal. In order to reduce engagement noise, it is recommended that all shifts be performed at speeds below 3 mph (5 km/h).

**Note:** The vehicle should not be driven in 4X4 High with the hub locks disengaged as this condition may damage driveline system components.

Engage the locking hubs by rotating the hub lock control from FREE to LOCK, then move the transfer case lever from 2H to 4H at a stop or a vehicle speed below 3 mph (5 km/h).

Move the transfer case lever from 4H to 2H at a stop or a vehicle speed below 3 mph (5 km/h), then disengage the locking hubs (optional) by rotating the hub lock control from LOCK to FREE.

For proper operation, make sure that both hubs are set to either FREE or LOCK.

## Shifting to or from 4L (4X4 Low)

1. Bring the vehicle to a stop or a speed below 3 mph (5 km/h).
2. Place the transmission in N (Neutral).

3. Move the transfer case shift lever through N (Neutral) directly to the desired position.
4. If the transfer case does not, or only partially moves to the desired position, perform a shift with the transmission in N (Neutral) and the vehicle rolling at a speed below 3 mph (5 km/h).
5. If shifting to 2H with the vehicle at a complete stop, disengage the locking hubs (optional) by rotating the hub lock control from LOCK to FREE.

## Using the N (Neutral) position

### WARNING



Always set the parking brake and leave your vehicle with the transmission in park (P).



E233846

The transfer case neutral position overrides the transmission and puts the vehicle in neutral regardless of transmission gearshift lever position. The vehicle can move forward or backwards.

This position should only be used when towing the vehicle.

# Four-Wheel Drive (If Equipped)

## Using the Electronic Shift on the Fly 4WD system (If Equipped)

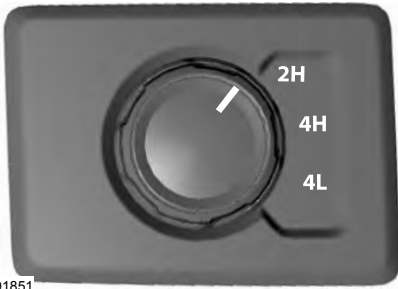

### 2H (4X2)

For general on-road driving. Sends power to the rear wheels only and should be used for street and highway driving. Provides optimal smoothness and fuel economy at high speeds.

### 4H (4X4 HIGH)

Provides mechanically locked four-wheel drive power to both the front and rear wheels for use in off-road or winter conditions such as deep snow, sand or mud. This mode is not for use on dry pavement.

### 4L (4X4 LOW)

Provides mechanically locked four-wheel drive power to both the front and rear wheels for use on low traction surfaces, but does so with additional gearing for increased torque multiplication. Intended only for off-road applications such as deep sand, steep grades, or pulling heavy objects. 4L (4X4 low) will not engage while your vehicle is moving above 3 mph (5 km/h); this is normal and should be no reason for concern. Refer to Shifting to or from 4L (4X4 low) for proper operation.

## Shifting between system modes

**Note:** Momentarily releasing the accelerator pedal when a shift in progress message displays improves engagement or disengagement performance.

**Note:** Do not perform this operation if the rear wheels are slipping or when applying the accelerator pedal.

**Note:** Some noise may be heard as the system shifts or engages; this is normal.

**Note:** 4X4 high mode is not intended for use on dry pavement.

You can move the control from 2H or 4H at a stop or while driving. The information display may display a message indicating a 4X4 shift is in progress. Once the shift is complete the message center will then display the system mode selected.

## Shifting to or from 4L (4X4 low)

**Note:** Some noise may be heard as the system shifts or engages; this is normal.

**Note:** 4x4 low mode is not intended for use on dry pavement.

1. Bring the vehicle to a speed of 3 mph (5 km/h) or less.
2. Place the transmission in N (Neutral).
3. Move the 4WD control to the desired position.

The information display will display a message indicating a 4X4 shift is in progress. The information display will then display the system mode selected. If any of the above shift conditions are not met, the shift will not occur and the information display will display information guiding the driver through the proper shifting procedures.

## Four-Wheel Drive (If Equipped)

If **Shift Delayed Pull Forward** appears in the information display, transfer case gear tooth blockage is present. To alleviate this condition, place the transmission in a forward gear, move the vehicle forward approximately 5 ft (1.5 m), and shift the transmission back to neutral to allow the transfer case to complete the range shift.

### How Your Vehicle Differs From Other Vehicles

#### WARNING



Vehicles with a higher center of gravity (utility and four-wheel drive vehicles) handle differently than vehicles with a lower center of gravity (passenger cars). Avoid sharp turns, excessive speed and abrupt steering in these vehicles. Failure to drive cautiously increases the risk of losing control of your vehicle, vehicle rollover, personal injury and death.

Truck and utility vehicles can differ from some other vehicles. Your vehicle may be higher to allow it to travel over rough terrain without getting hung up or damaging underbody components.

The differences that make your vehicle so versatile also make it handle differently than an ordinary passenger car.

Maintain steering wheel control at all times, especially in rough terrain. Since sudden changes in terrain can result in abrupt steering wheel motion, make sure you grip the steering wheel from the outside. Do not grip the spokes.

Drive cautiously to avoid vehicle damage from concealed objects such as rocks and stumps.

You should either know the terrain or examine maps of the area before driving. Map out your route before driving in the area. To maintain steering and braking control of your vehicle, you must have all four wheels on the ground and they must be rolling, not sliding or spinning.

### Driving Off-Road With Truck and Utility Vehicles

**Note:** *On some models, the initial shift from two-wheel drive to four-wheel drive while the vehicle is moving can cause some momentary clunk and ratcheting sounds. This is the front drivetrain coming up to speed and the automatic locking hubs engaging and is not cause for concern.*

**Note:** *Your vehicle may be equipped with a front air dam that can become damaged (due to reduced ground clearance) when taking your vehicle off-road. This air dam can be taken off by removing 15 bolts.*

Four-wheel drive vehicles are specially equipped for driving on sand, snow, mud and rough terrain and have operating characteristics that are somewhat different from conventional vehicles, both on and off the road.

Power is supplied to all four wheels through a transfer case. On four-wheel drive vehicles, the transfer case allows you to select 4WD when necessary. Information on transfer case operation and shifting procedures can be found in this chapter. Information on transfer case maintenance can be found in the Maintenance chapter. You should become thoroughly familiar with this information before you operate your vehicle.

Four-wheel drive (when you select a 4WD mode) uses all four wheels to power the vehicle. This increases traction, enabling you to drive over terrain and road conditions that a conventional two-wheel drive vehicle cannot.

# Four-Wheel Drive (If Equipped)

---

## Basic Operating Principles

- Drive slower in strong crosswinds which can affect the normal steering characteristics of your vehicle.
- When driving your vehicle on surfaces made slippery by loose sand, water, gravel, snow or ice proceed with care.
- Do not use 4H or 4L on dry, hard surfaced roads. Doing so will produce excessive noise, increase tire wear and may damage drive components. 4H or 4L modes are only intended for consistently slippery or loose surfaces.

## If Your Vehicle leaves the Road

If your vehicle leaves the road, reduce your vehicle speed and avoid severe braking. When your vehicle speed has been reduced ease your vehicle back onto the road. Do not turn the steering wheel sharply while returning your vehicle to the road.

It may be safer to stay on the shoulder of the road and slow down gradually before returning to the road. You may lose control if you do not slow down or if you turn the steering wheel too sharply or abruptly.

It may be less risky to strike small objects, such as freeway reflectors, with minor damage to your vehicle rather than attempt a sudden return to the road which could cause your vehicle to slide sideways out of control or roll over. Remember, your safety and the safety of others should be your primary concern.

## Emergency Maneuvers

In an unavoidable emergency situation where a sudden sharp turn must be made, remember to avoid over-driving your vehicle (i.e. turn the steering wheel only as rapidly and as far as required to avoid the emergency). Excessive steering can result in loss of vehicle control. Apply smooth pressure to the accelerator pedal or brake pedal when changes in vehicle speed are

required. Avoid abrupt steering, acceleration and braking. This could result in an increased risk of vehicle roll over, loss of vehicle control and personal injury. Use all available road surface to bring your vehicle to a safe direction of travel.

In the event of an emergency stop, avoid skidding the tires and do not attempt any sharp steering wheel movements.

If your vehicle goes from one type of surface to another (i.e. from concrete to gravel) there will be a change in the way your vehicle responds to a maneuver (i.e. steering, acceleration or braking).

## Sand

When driving over sand, try to keep all four wheels on the most solid area of the trail. Avoid reducing the tire pressures but shift to a lower gear and drive steadily through the terrain. Apply the accelerator slowly and avoid excessive wheel slip.

When driving at slow speeds in deep sand under high outside temperatures, use a low gear when possible. Low gear operation will maximize the engine and transmission cooling capability.

Avoid driving at excessive speeds, this causes vehicle momentum to work against you and your vehicle could become stuck to the point that assistance may be required from another vehicle. Remember, you may be able to back out the way you came if you proceed with caution.

## Mud and Water

### Mud

Be cautious of sudden changes in vehicle speed or direction when you are driving in mud. Even four-wheel drive vehicles can lose traction in slick mud. If your vehicle does slide, steer in the direction of the slide until you regain control of your vehicle.

## Four-Wheel Drive (If Equipped)

After driving through mud, clean off residue stuck to rotating driveshafts and tires. Excess mud stuck on tires and rotating driveshafts can cause an imbalance that could damage drive components.

### Water

If you must drive through high water, drive slowly. Traction or brake capability may be limited.

When driving through water, determine the depth and avoid water higher than the bottom of the hubs. If the ignition system gets wet, your vehicle may stall.

Once through water, always try the brakes. Wet brakes do not stop your vehicle as effectively as dry brakes. Drying can be improved by applying light pressure to the brake pedal while moving slowly.

**Note:** *Driving through deep water may damage the transmission. If the front or rear axle is submerged in water, the axle lubricant and power transfer unit lubricant should be checked and changed if necessary.*

### Driving on Hilly or Sloping Terrain

Although natural obstacles may make it necessary to travel diagonally up or down a hill or steep incline, you should always try to drive straight up or straight down.

**Note:** *Avoid turning on steep slopes or hills. A danger lies in losing traction, slipping sideways and possible vehicle roll over. Whenever driving on a hill, determine beforehand the route you will use. Do not drive over the crest of a hill without seeing what conditions are on the other side. Do not drive in reverse over a hill without the aid of an observer.*

When climbing a steep slope or hill, start in a lower gear rather than downshifting to a lower gear from a higher gear once the ascent has started. This reduces strain on the engine and the possibility of stalling.

If your vehicle stalls, do not try to turn around because this could cause vehicle roll over. It is better to reverse back to a safe location.

Apply just enough power to the wheels to climb the hill. Too much power will cause the tires to slip, spin or lose traction, resulting in loss of vehicle control.



E143949

Descend a hill in the same gear you would use to climb up the hill to avoid excessive brake application and brake overheating. Do not descend in neutral. Disengage overdrive or move the transmission selector lever to a lower gear. When descending a steep hill, avoid sudden hard braking as you could lose control. The front wheels have to be turning in order to steer your vehicle.

If your vehicle has anti-lock brakes, apply the brakes steadily. Do not pump the brakes.

## Four-Wheel Drive (If Equipped)

### Driving on Snow and Ice

#### WARNING



If you are driving in slippery conditions that require tire chains or cables, then it is critical that you drive cautiously. Keep speeds down, allow for longer stopping distances and avoid aggressive steering to reduce the chances of a loss of vehicle control which can lead to serious injury or death. If the rear end of your vehicle slides while cornering, steer in the direction of the slide until you regain control of your vehicle.

**Note:** Excessive tire slippage can cause transmission damage.

Four-wheel drive vehicles have advantages over two-wheel drive vehicles in snow and ice but can skid like any other vehicle. Should you start to slide while driving on snowy or icy roads, turn the steering wheel in the direction of the slide until you regain control.

Avoid sudden applications of power and quick changes of direction on snow and ice. Apply the accelerator slowly and steadily when starting from a full stop.

Avoid sudden braking. Although a four-wheel drive vehicle may accelerate better than a two-wheel drive vehicle in snow and ice, it will not stop any faster as braking occurs at all four wheels. Do not become overconfident as to road conditions.

Make sure you allow sufficient distance between you and other vehicles for stopping. Drive slower than usual and consider using one of the lower gears. In emergency stopping situations, apply the brake steadily. Do not pump the brake pedal. See **Hints on Driving With Anti-Lock Brakes** (page 227).

### If Your Vehicle Gets Stuck In Mud or Snow

#### WARNING



Do not spin the wheels at over 34 mph (55 km/h). The tires may fail and injure a passenger or bystander.

If your vehicle gets stuck in mud or snow, it may be rocked out by shifting between forward and reverse gears, stopping between shifts in a steady pattern. Press lightly on the accelerator in each gear.

**Note:** Do not rock your vehicle if the engine is not at normal operating temperature, damage to the transmission may occur.

**Note:** Do not rock your vehicle for more than a minute, damage to the transmission and tires may occur or the engine may overheat.

### Parking

#### WARNINGS



If the parking brake is fully released, but the brake warning lamp remains illuminated, the brakes may not be working properly. Have your vehicle checked as soon as possible.



Always set the parking brake and leave your vehicle with the transmission in park (P).

On some four-wheel drive vehicles, when the transfer case is in the N (Neutral) position, the engine and transmission are disconnected from the rest of the driveline. Therefore, the vehicle is free to roll even if the automatic transmission is in P (Park) or the manual transmission is in gear. Do not leave the vehicle unattended with the transfer case in the N (Neutral) position. Always set the parking brake fully and turn off the ignition when leaving the vehicle.



## Four-Wheel Drive (If Equipped)

---

### **Maintenance and Modifications**

The suspension and steering systems on your vehicle have been designed and tested to provide predictable performance whether loaded or empty. For this reason, we strongly recommend that you do not make modifications such as adding or removing parts (i.e. lift kits or stabilizer bars) or by using replacement parts not equivalent to the original factory equipment.

We recommend that you use caution when your vehicle has either a high load or device (i.e. ladder or luggage racks). Any modifications to your vehicle that raise the center of gravity may cause your vehicle to roll over when there is a loss of vehicle control.

Failure to maintain your vehicle correctly may void the warranty, increase your repair cost, reduce vehicle performance and operational capabilities and adversely affect you and your passenger's safety. We recommend you frequently inspect your vehicle's chassis components when your vehicle is subject to off road usage.

# Rear Axle

## LIMITED SLIP DIFFERENTIAL

This axle provides added traction on slippery surfaces, particularly when one wheel is on a poor traction surface. Under normal conditions, the limited-slip axle functions like a standard rear axle. The axle may exhibit a slight noise or vibration during tight turns with low vehicle speed. This is normal behavior and indicates the axle is working.

## ELECTRONIC LOCKING DIFFERENTIAL (if Equipped)

**Note:** *The electronic locking differential is for off-road use only and is not for use on dry pavement. Using the electronic locking differential on dry pavement will result in increased tire wear, noise and vibration.*

The electronic locking differential is a device housed in the rear axle that allows both rear wheels to turn at the same speed. The electronic locking differential can provide additional traction should your vehicle become stuck. You can activate the differential electronically and shift it on the fly within the differential operating speed range. The differential is for use in mud, rocks, sand, or any off-road condition where you need maximum traction. It is not for use on dry pavement.

The following conditions will affect the electronic locking differential:

- The electronic locking differential will not engage if your vehicle speed is above 20 mph (32 km/h) in 4x2 or 4x4 High modes.
  - The electronic locking differential will not engage if your vehicle speed is above or 56 mph (90 km/h) in 4X4 Low.
- The electronic locking differential may not engage if you press your accelerator pedal during an engagement attempt. A message may display in the instrument display guiding you to release the accelerator pedal.
  - In 4x2 or 4x4 High modes, the electronic locking differential will automatically disengage at speeds above 25 mph (41 km/h) and will automatically reengage at speeds below 20 mph (32 km/h).
  - In 4L (4X4 low), the electronic locking differential will automatically disengage at speeds above 62 mph (100 km/h) and will automatically reengage at speeds below 56 mph (90 km/h).
  - The AdvanceTrac system has the ability to take over control of the electronic locking differential and disable it during driving maneuvers when necessary.

When you switch the system on, if you do not meet the required conditions for electronic locking differential activation, the instrument cluster will display the appropriate information guiding you through the proper activation process.

## Activating the Electronic Locking Differential

**Note:** *Do not use electronic locking differential on dry, hard surfaced roads. Doing so will produce excessive noise, vibration and increase tire wear.*

**Note:** *If the electronic locking differential has difficulty disengaging, release the accelerator pedal and turn the steering wheel in the opposite direction while rolling.*

# Rear Axle

## For 4WD vehicles

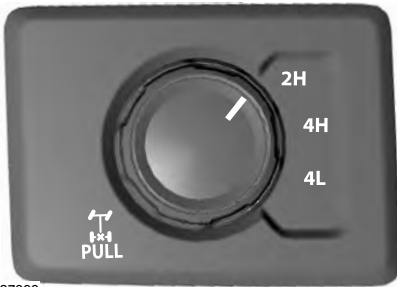

E227398

Pull the 4WD control knob toward you.

- The vehicle speed is too high.
- The left and right rear wheel speed difference is too high during an engagement attempt.
- The system has malfunctioned and is accompanied by a message in the information display. See your authorized Ford dealer for assistance.

## For 2WD vehicles

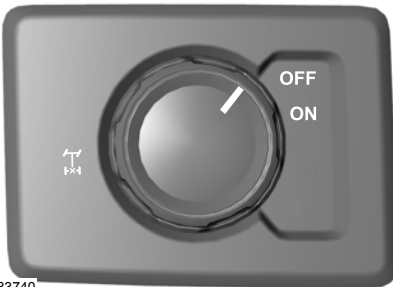

E183740

Turn the control to ON.

 Once the indicator light illuminates in the information display, both rear wheel axle shafts will be locked together providing added traction.

If the indicator does not come on, or the indicator turns off while driving, one of the following has occurred:

# Brakes

## GENERAL INFORMATION

**Note:** Occasional brake noise is normal. If a metal-to-metal, continuous grinding or continuous squeal sound is present, the brake linings may be worn-out. Have the system checked by an authorized dealer. If your vehicle has continuous vibration or shudder in the steering wheel while braking, have it checked by an authorized dealer.

**Note:** Brake dust may accumulate on the wheels, even under normal driving conditions. Some dust is inevitable as the brakes wear and does not contribute to brake noise.



See **Warning Lamps and Indicators** (page 108).

Wet brakes result in reduced braking efficiency. Gently press the brake pedal a few times when driving from a car wash or standing water to dry the brakes.

## Brake Over Accelerator

In the event the accelerator pedal becomes stuck or entrapped, apply steady and firm pressure to the brake pedal to slow the vehicle and reduce engine power. If you experience this condition, apply the brakes and bring your vehicle to a safe stop. Shift the transmission to park (P), switch the engine off and apply the parking brake. Inspect the accelerator pedal for any interference. If none are found and the condition persists, have your vehicle towed to the nearest authorized dealer.

## Brake Assist

Brake assist detects when you brake rapidly by measuring the rate at which you press the brake pedal. It provides maximum braking efficiency as long as you press the pedal, and can reduce stopping distances in critical situations.

## Anti-lock Brake System

This system helps you maintain steering control during emergency stops by keeping the brakes from locking.



This lamp momentarily illuminates when you switch the ignition on. If the light does not illuminate during start up, remains on or flashes, the system may be disabled. Have the system checked by an authorized dealer. If the anti-lock brake system is disabled, normal braking is still effective.



If the brake warning lamp remains illuminated after you release the parking brake, have the system checked by an authorized dealer.

It also illuminates momentarily when you switch the ignition on to confirm the lamp is functional. If it does not illuminate when you switch the ignition on, or begins to flash at any time, have the system checked by an authorized dealer.

## Diesel Engine Exhaust Braking (If

Equipped)

### WARNINGS



Do not use tow/haul when the road surface is slippery. Failure to follow this instruction could result in the loss of control of your vehicle.



Do not use diesel engine exhaust braking when the road surface is slippery. Failure to follow this instruction could result in the loss of control of your vehicle.

This feature increases engine braking at higher engine speeds to provide better grade descent control with less brake and transmission wear and tear.

**Note:** Use this when driving downhill and carrying heavy loads or trailering.

# Brakes

Benefits of engine braking are:

- Lower brake temperature.
- Reduced brake fade.
- Longer brake life.
- Improved driving and trailering control.



Press the button on the switch bank next to the audio unit to switch the system on or off.

There are two engine brake modes, manual and automatic.

## Manual Engine Braking

1. Press the button to switch on manual engine braking.
2. Release the accelerator pedal to maximize engine braking.
3. Apply the brakes. The transmission downshifts to lower gears.

**Note:** *The engine braking feature only functions when you release the accelerator.*

**Note:** *You can shift the transmission to lower gears with progressive range selection (PRS) or manual shifting independent of pressing the brakes.*

**Note:** *You can also use manual engine braking with cruise control to improve grade descent control.*

**Note:** *If your vehicle has Adaptive Cruise Control, the speed control system uses the selected engine brake mode, transmission gears, and brakes to maintain the set speed and distance to the vehicle being followed.*

## Automatic Engine Braking

1. Press the button twice to switch on automatic engine braking.
2. Release the accelerator or brake pedal. The system remembers your vehicle speed.

**Note:** *This feature offers smoother, less aggressive engine braking during downhill descents. It may not apply braking if the vehicle speed is not increasing, although it will apply full engine braking force when needed to prevent acceleration. The system automatically activates the engine brake and, if necessary, downshifts the transmission to lower gears to not exceed your vehicle's set speed when the brake or accelerator were last released.*

## Warning Lamp Conditions

- Illuminates when this feature is switched on and the system is operating properly. See **Warning Lamps and Indicators** (page 108).
- Flashes when the engine brake is disabled due to a fault or the engine does not meet the required braking conditions.
- Does not illuminate when the switch or indicator is faulty.

You can switch the system on at anytime. The system becomes active once the braking conditions are met.

## Braking Conditions

- Your vehicle is in a forward gear.
- The engine speed is above about 1500 RPM.
- Your foot is off the accelerator.

You can use this feature with tow/haul or progressive range selection to provide further increased engine braking. The transmission automatically upshifts to prevent the engine from entering the red zone on the tachometer. See **Automatic Transmission** (page 208).

# Brakes

## HINTS ON DRIVING WITH ANTI-LOCK BRAKES

The anti-lock braking system does not eliminate the risks when:

- You drive too closely to the vehicle in front of you.
- Your vehicle is hydroplaning.
- You take corners too fast.
- The road surface is poor.

**Note:** *If the system activates, the brake pedal may pulse and may travel further. Maintain pressure on the brake pedal. You may also hear a noise from the system. This is normal.*

## PARKING BRAKE

### WARNING



Always set the parking brake fully and make sure the transmission is placed in park (P). Failure to set the parking brake and engage park could result in vehicle roll-away, property damage or bodily injury. Turn the ignition to the lock position and remove the key whenever you leave your vehicle.

Apply the parking brake whenever your vehicle is parked. Press the pedal downward to set the parking brake. The brake warning lamp in the instrument cluster will illuminate and remains illuminated until the parking brake is released.

To release, pull the brake release lever located at the lower left side of the instrument panel.

If you are parking your vehicle on a grade or with a trailer, press and hold the brake pedal down, then set the parking brake. There may be a little vehicle movement as the parking brake sets to hold the vehicle's weight. This is normal and should be no reason for concern. If needed, press and hold the service brake pedal down, then try reapplying the parking brake. Chock the wheels if required. If the parking brake cannot hold the weight of the vehicle, the parking brake may need to be serviced or the vehicle may be overloaded.

## HILL START ASSIST

### WARNINGS



The system does not replace the parking brake. When you leave your vehicle, always apply the parking brake.



You must remain in your vehicle when the system turns on. At all times, you are responsible for controlling your vehicle, supervising the system and intervening, if required. Failure to take care may result in the loss of control of your vehicle, serious personal injury or death.



The system will turn off if a malfunction is apparent or if you rev the engine excessively. Failure to take care may result in the loss of control of your vehicle, serious personal injury or death.

The system makes it easier to pull away when your vehicle is on a slope without the need to use the parking brake.

When the system is active, your vehicle remains stationary on the slope for two to three seconds after you release the brake pedal. This allows time to move your foot from the brake to the accelerator pedal. The system releases the brakes

# Brakes

---

automatically once the engine has developed sufficient torque to prevent your vehicle from rolling down the slope. This is an advantage when pulling away on a slope, for example from a car park ramp, traffic lights or when reversing uphill into a parking space.

The system activates on any slope that causes your vehicle to roll.

**Note:** *There is no warning light to indicate the system is either on or off.*

## Using Hill Start Assist

1. Press the brake pedal to bring your vehicle to a complete standstill. Keep the brake pedal pressed and shift into first gear when facing uphill or reverse (R) when facing downhill.
2. If the sensors detect that your vehicle is on a slope, the system activates automatically.
3. When you remove your foot from the brake pedal, your vehicle remains on the slope without rolling away for about two to three seconds. This hold time automatically extends if you are in the process of driving off.
4. Drive off in the normal manner. The system releases the brakes automatically.

**Note:** *When you remove your foot from the brake pedal and press the pedal again when the system is active, you will experience significantly reduced brake pedal travel. This is normal.*

## Switching the System On and Off

### Vehicles with Manual Transmission

You can switch this feature on or off in the information display. The system remembers the last setting when you start your vehicle.

### Vehicles with Automatic Transmission

You cannot turn the system on or off. When you switch the ignition on, the system automatically turns on.

# Traction Control

## PRINCIPLE OF OPERATION

The traction control system helps avoid drive wheel spin and loss of traction.

If your vehicle begins to slide, the system applies the brakes to individual wheels and, when needed, reduces engine power at the same time. If the wheels spin when accelerating on slippery or loose surfaces, the system reduces engine power in order to increase traction.



E166706

Use the traction and stability control switch on the instrument panel to switch the system off or on.

The switch illuminates when traction control is off.

When you place your vehicle into four-wheel drive low mode the traction control disables. Traction control resumes full operation when you put your vehicle back into two-wheel drive mode.

## USING TRACTION CONTROL

### WARNING



The stability and traction control light illuminates steadily if the system detects a failure. Make sure you did not manually disable the traction control system using the information display controls or the switch. If the stability control and traction control light is still illuminating steadily, have the system serviced by an authorized dealer immediately. Operating your vehicle with the traction control disabled could lead to an increased risk of loss of vehicle control, vehicle rollover, personal injury and death.

The system automatically turns on each time you switch the ignition on.

If your vehicle is stuck in mud or snow, switching traction control off may be beneficial as this allows the wheels to spin.

**Note:** When you switch traction control off, stability control remains fully active.

**Note:** For additional information on the traction and stability control systems. See **Using Stability Control** (page 231).

## Switching the System Off

When you switch the system off or on, a message appears in the information display showing system status.

## System Indicator Lights and Messages



The stability and traction control light:

- Temporarily illuminates on engine start-up.
- Flashes when a driving condition activates either of the systems.
- Illuminates if a problem occurs in either of the systems.



The stability and traction control off light temporarily illuminates on engine start-up and stays on when you switch the traction control system off.



# Stability Control

## PRINCIPLE OF OPERATION

### WARNINGS



Vehicle modifications involving braking system, aftermarket roof racks, suspension, steering system, tire construction and wheel and tire size may change the handling characteristics of your vehicle and may adversely affect the performance of the electronic stability control system. In addition, installing any stereo loudspeakers may interfere with and adversely affect the electronic stability control system. Install any aftermarket stereo loudspeaker as far as possible from the front center console, the tunnel, and the front seats in order to minimize the risk of interfering with the electronic stability control sensors. Reducing the effectiveness of the electronic stability control system could lead to an increased risk of loss of vehicle control, vehicle rollover, personal injury and death.



Remember that even advanced technology cannot defy the laws of physics. It's always possible to lose control of a vehicle due to inappropriate driver input for the conditions. Aggressive driving on any road condition can cause you to lose control of your vehicle increasing the risk of personal injury or property damage. Activation of the electronic stability control system is an indication that at least some of the tires have exceeded their ability to grip the road; this could reduce the operator's ability to control the vehicle potentially resulting in a loss of vehicle control, vehicle rollover, personal injury and death. If your electronic stability control system activates, **SLOW DOWN**.

The system automatically turns on each time you switch the ignition on.

If a fault occurs in either the stability control or the traction control system, you may experience the following conditions:

- The stability and traction control light illuminates steadily.
- The stability control and traction control systems do not enhance your vehicle's ability to maintain traction of the wheels.
- The Adaptive Steering system (if equipped) automatically changes the steering function to a fixed steering ratio. See **Steering** (page 259).

If a driving condition activates either the stability control or the traction control system you may experience the following conditions:

- The stability and traction control light flashes.
- Your vehicle slows down.
- Reduced engine power.
- A vibration in the brake pedal.
- The brake pedal is stiffer than usual.
- If the driving condition is severe and your foot is not on the brake, the brake pedal may move as the system applies higher brake force.

The stability control system has several features built into it to help you maintain control of your vehicle:

### Electronic Stability Control

The system enhances your vehicle's ability to prevent skids or lateral slides by applying brakes to one or more of the wheels individually and, if necessary, reducing engine power.

# Stability Control

## Roll Stability Control

The system enhances your vehicle's ability to prevent rollovers by detecting your vehicle's roll motion and the rate at which it changes by applying the brakes to one or more wheels individually.

## Traction Control

The system enhances your vehicle's ability to maintain traction of the wheels by detecting and controlling wheel spin. See **Using Traction Control** (page 229).

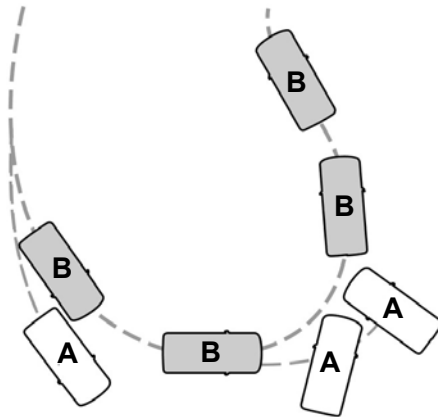

E72903

- A Vehicle without stability control skidding off its intended route.
- B Vehicle with stability control maintaining control on a slippery surface.

## USING STABILITY CONTROL

### AdvanceTrac® with Roll Stability Control™ (RSC®)

The system automatically turns on each time you switch the ignition on.

The electronic stability control and roll stability control portions of the system can be turned off.

When you shift the transmission into reverse **R**, the systems disable.



Use the traction and stability control switch on the instrument panel to switch the systems off or on.

You can switch the traction control portion of the system off independently.

If you cannot turn the systems off, see the MyKey chapter for more information.

# Stability Control

<b>AdvanceTrac with RSC Features</b>				
<b>Button functions</b>	<b>Stability control light</b>	<b>Roll stability control</b>	<b>Electronic stability control</b>	<b>Traction control system</b>
Default at start-up	Illuminated during bulb check	Enabled	Enabled	Enabled
Button pressed momentarily	Illuminated	Enabled	Enabled <sup>1</sup>	Disabled
Button pressed and held for more than 5 seconds	illuminated <sup>3</sup>	Disabled	Disabled	Disabled
Double Press (Pickup Only)	Illuminated	Enabled	Enabled <sup>1</sup>	Enabled <sup>2</sup>
Button pressed again after deactivation	Not illuminated	Enabled	Enabled	Enabled
Transfer case switched to 4WD Low <sup>4</sup>	Illuminated	Disabled	Disabled	Disabled

<sup>1</sup>Electronic stability control has reduced sensitivity compared to fully active system.

<sup>2</sup>Traction control has reduced sensitivity compared to fully active system.

<sup>3</sup>Lamp light starts blinking for four seconds after entering the press and hold state.

<sup>4</sup>Engaging 4WD Low automatically disables roll stability control, electronic stability control and the traction control systems.

# Terrain Control (If Equipped)

## PRINCIPLE OF OPERATION

### WARNINGS



Hill descent control cannot control descent in all surface conditions and circumstances, such as ice or extremely steep grades. Hill descent control is a driver assist system and cannot substitute for good judgment by the driver. Failure to do so may result in loss of vehicle control, crash or serious injury.



Hill descent control does not provide hill hold at zero miles per hour (0 kilometers per hour). When stopped, the parking brake must be applied or the vehicle must be placed in **P** (Park) or it may roll away.

Hill descent control allows the driver to set and maintain vehicle speed while descending steep grades in various surface conditions.

Hill descent control can maintain vehicle speeds on downhill grades between 2 mph (3 km/h) and 12 mph (20 km/h). Above 20 mph (32 km/h), the system remains armed, but descent speed cannot be set or maintained.

Hill descent control requires a cooling down interval after a period of sustained use. The amount of time that the feature can remain active before cooling varies with conditions. The system will provide a warning in the message center and a chime will sound when the system is about to disengage for cooling. At this time, manually apply the brakes as needed to maintain descent speed.

## USING HILL DESCENT CONTROL



Press and release the hill descent button located on the instrument panel. A light in the cluster will illuminate and a chime will sound when this feature is activated.

To increase descent speed, press the accelerator pedal until the desired speed is reached. To decrease descent speed, press the brake pedal until the desired speed is reached.

Whether accelerating or decelerating, once the desired descent speed is reached, remove your feet from the pedals and the chosen vehicle speed will be maintained.

**Note:** *Noise from the ABS pump motor may be observed during hill descent control operation. This is a normal characteristic of the ABS and should be no reason for concern.*

### Hill descent modes

- At speeds below 20 mph (32 km/h): When the Hill Descent Control switch is pressed and Hill Descent Control is active, the Hill Descent Control telltale will flash.
- At speeds below 20 mph (32 km/h): When the Hill Descent Control switch is pressed and conditions are not correct for hill descent activation, the Hill Descent Control system will be enabled, the Hill Descent Control telltale will be solid and a message will display in the information display.
- At speeds above 20 mph (32 km/h): When the Hill Descent Control switch is pressed, the Hill Descent Control system will be enabled, the telltale in the cluster will not be illuminated and a message will be displayed in the information display.

## Terrain Control (If Equipped)

---

Refer to the Information Displays for additional Hill Descent Control messages. See **Information Messages** (page 129).

# Parking Aids

## PRINCIPLE OF OPERATION

### WARNINGS



To help avoid personal injury, always use caution when in reverse (R) and when using the sensing system.



The system may not detect objects with surfaces that absorb reflection. Always drive with due care and attention. Failure to take care may result in a crash.



Traffic control systems, inclement weather, air brakes, external motors and fans may affect the correct operation of the sensing system. This may cause reduced performance or false alerts.



The system may not detect small or moving objects, particularly those close to the ground.

**Note:** The sensing system cannot be turned off when a MyKey is present. See **Principle of Operation** (page 63).

The sensing system warns the driver of obstacles within a certain range of your vehicle. The system turns on automatically whenever you switch the ignition on.

When receiving a detection warning, the radio volume reduces to a predetermined level. After the warning goes away, the radio volume returns to the previous level.

The sensing system can be switched off through the information display menu or from the pop-up message that appears once you shift the transmission into reverse (R). See **General Information** (page 113).

If a fault is present in the system, a warning message appears in the information display and you cannot switch the system on through the pop-up message. See **Information Messages** (page 129).

**Note:** Certain add-on devices installed around the bumper or fascia may create false beeps. For example, large trailer hitches, bike or surfboard racks, license plate brackets, bumper covers or any other device that may block the normal detection zone of the system.

**Note:** Keep the sensors, located on the bumper or fascia, free from snow, ice and large accumulations of dirt. If the sensors are covered, the system's accuracy can be affected. Do not clean the sensors with sharp objects.

**Note:** If your vehicle sustains damage to the bumper or fascia, leaving it misaligned or bent, the sensing zone may be altered causing inaccurate measurement of obstacles or false alarms. See your authorized technician.

**Note:** When a trailer is connected to your vehicle, the rear parking aid may detect the trailer and therefore provide warnings. Disable the rear parking aid when a trailer is connected to prevent these warnings.

## REAR PARKING AID (If Equipped)

The rear sensors are only active when the transmission is in reverse (R). As your vehicle moves closer to the obstacle, the rate of the audible warning increases. When the obstacle is less than 12 in (30 cm) away, the warning sounds continuously. If the system detects a stationary or receding object farther than 12 in (30 cm) from the corners of the bumper, the tone sounds for only three seconds. Once the system detects an object approaching, the warning sounds again.

# Parking Aids



E231381

Coverage area of up to 6 ft (1.8 m) from the rear bumper. There may be decreased coverage area at the outer corners of the bumper.

The system detects certain objects while the transmission is in reverse (R) :

- Your vehicle is moving toward a stationary object at a speed of 3 mph (5 km/h) or less.
- Your vehicle is not moving, but a moving object is approaching the rear of your vehicle at a speed of 3 mph (5 km/h) or less.
- Your vehicle is moving at a speed of less than 3 mph (5 km/h) and a moving object is approaching the rear of your vehicle at a speed of less than 3 mph (5 km/h).

The system provides audio warnings only when your vehicle is moving or when your vehicle is stationary and the detected obstacle is less than 12 in (30 cm) away from the bumper.

## **Obstacle Distance Indicator (if Equipped)**

The system provides obstacle distance indication through the display screen. See **Rear View Camera** (page 236).

## **REAR VIEW CAMERA (if Equipped)**

### **WARNINGS**

 The rear view camera system is a reverse aid supplement device that still requires the driver to use it in conjunction with the interior and exterior mirrors for maximum coverage.

 Objects that are close to either corner of the bumper or under the bumper, might not be seen on the screen due to the limited coverage of the camera system.

 Reverse your vehicle as slow as possible, higher speeds may limit your reaction time to stop your vehicle.

 Use caution when the tailgate is ajar. If the tailgate is ajar, the camera will be out of position and the video image may be incorrect. All guidelines disappear when the tailgate is ajar. Some vehicles may not come equipped with guidelines.

 Use caution when turning camera features on or off when the transmission is not in park (P). Make sure your vehicle is not moving.

The rear view camera system displays what is behind your vehicle when you shift the transmission into reverse (R).

During operation, lines appear in the display that represents the path of your vehicle and proximity to objects behind it.

# Parking Aids



The rear view camera is located on the tailgate.

## Using the Rear View Camera System

The system uses three types of guides to help you see what is behind your vehicle:

- Active guidelines: Show the intended path of your vehicle when reversing.
- Fixed guidelines: Show the actual path your vehicle is moving while reversing in a straight line. This can be helpful when backing into a parking space or aligning your vehicle with another object behind you.
- Centerline: Helps align the center of your vehicle with an object (for example, a trailer).

**Note:** *If the transmission is in reverse (R) and the tailgate is ajar, no rear view camera features are displayed.*

**Note:** *If the image does not turn off while the transmission is not in reverse (R) and you are driving over a speed of 5 mph (8 km/h), have the system inspected by an authorized dealer.*

**Note:** *When towing, the camera only sees what is being towed behind your vehicle. This might not provide adequate coverage as it usually provides in normal operation and some objects might not be seen. In some vehicles, the guidelines may disappear once the trailer tow connector is engaged.*

The camera may not operate correctly under the following conditions:

- Nighttime or dark areas if the reverse lamps are not operating.
- Mud, water or debris obstructs the camera's view. Clean the lens with a soft, lint-free cloth and non-abrasive cleaner.
- The camera is misaligned due to damage to the rear of your vehicle.

## Camera Guidelines

**Note:** *Active guidelines and fixed guidelines are only available when the transmission is in reverse (R).*

**Note:** *The centerline is only available if Active or Fixed guidelines are on.*

**Note:** *Some vehicles may not come equipped with guidelines.*



# Parking Aids

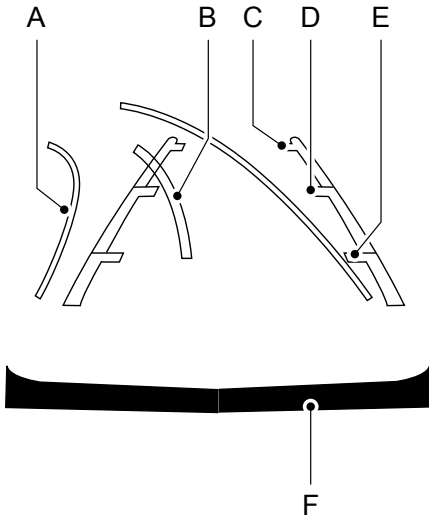

E142436

- A Active guidelines
- B Centerline
- C Fixed guideline: Green zone
- D Fixed guideline: Yellow zone
- E Fixed guideline: Red zone
- F Rear bumper

To use active guidelines, turn the steering wheel to point the guidelines toward an intended path. If the steering wheel position is changed while reversing, the vehicle might deviate from the original intended path.

The active guidelines fade in and out depending on the steering wheel position. The active guidelines are not shown when the steering wheel position is straight.

Always use caution while reversing. Objects in the red zone are closest to your vehicle and objects in the green zone are farther away. Objects are getting closer to your vehicle as they move from the green zone to the yellow or red zones. Use the side view mirrors and rear view mirror to get better coverage on both sides and rear of your vehicle.

## Obstacle Distance Indicator



E190459

The system will provide an image of your vehicle and the sensor zones. The zones will highlight green, yellow and red when the parking aid sensors detect an object in the coverage area.

## Rear Camera Delay

Selectable settings for this feature are ON and OFF.

# Parking Aids

When shifting the transmission out of reverse (R) and into any gear other than park (P), the camera image remains in the display until:

- Your vehicle speed sufficiently increases.
- You shift your vehicle into park (P).
- You apply the parking brake on vehicles with a manual transmission.

## 360 DEGREE CAMERA (If Equipped)

### WARNINGS



The 360 degree camera system still requires the driver to use it in conjunction with looking out of the windows, and checking the interior and exterior mirrors for maximum coverage.



Objects that are close to either corner of the bumper or under the bumper, might not be seen on the screen due to the limited coverage of the camera system.



Use caution when turning camera features on or off when the transmission is not in park (P). Make sure your vehicle is not moving.

**Note:** *The 360 degree camera system turns off when your vehicle is in motion at low speed, except when in reverse (R).*

The 360 degree camera system consists of front, side and rear cameras. The system:

- Allows you to see what is directly in front or behind your vehicle.
- Provides cross traffic view in front and behind your vehicle.

- Allows you to see a top-down view of the area outside your vehicle, including the blind spots.
- Provides visibility around your vehicle to you in parking maneuvers such as:
  - Centering in a parking space.
  - Obstacles near vehicle.
  - Parallel parking.

## Camera Views



The camera button is located on the instrument panel. Pressing the camera button activates the system.

When in park (P), neutral (N) or drive (D), only images from the front cameras are displayed. Press the camera button to display the front camera image on the display screen.

When in reverse (R), only images from the rear cameras are displayed. When you shift into reverse (R), the rear view camera image automatically shows on the display screen.

## Advanced Camera Views (If Equipped)



Additional camera views may be available for vehicles with specific features. Press the small camera icon shown on the top left corner of the display screen to open the camera view menu.

The following camera views can be accessed in park (P), neutral (N) or drive (D) when you press the camera button:

- **Front 360 + Normal:** Contains the normal front camera view next to a 360 degree camera view.
- **Front Normal View:** Provides an image of what is directly in front of your vehicle.

# Parking Aids

- **Front Split View:** Provides an extended view of what is in front of your vehicle.
- **Rear High View:** Provides an image of your truck bed and can be used to assist you when backing up to align and hitch a fifth wheel or gooseneck trailer.
- **Auxiliary View:** Provides a rear view image from the back of your trailer while reversing.

The following camera views can be accessed when you shift into reverse (R):

- **Rear 360 + Normal:** Contains the normal rear camera view next to a 360 degree camera view. Press the zoom (+) button to quickly access Rear Normal View from this screen.
- **Rear Normal View:** Provides an image of what is directly behind your vehicle.
- **Rear Split View:** Provides an extended view of what is behind your vehicle.
- **Rear High View:** Provides an image of your truck bed and can be used to assist you when backing up to align and hitch a fifth wheel or gooseneck trailer.
- **Auxiliary View:** Provides a rear view image from the back of your trailer while reversing.
- **Trailer Reverse Guidance View:** Provides an image of the rear of your vehicle using the side cameras, useful when reversing with a trailer. Use the arrows at the bottom of the screen to adjust the side camera position. See **Trailer Reversing Aids** (page 274).

## Keep Out Zone

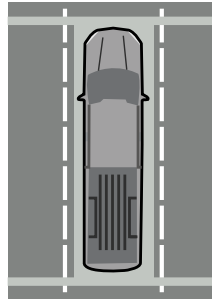

E184448

The Keep Out Zone is represented by the yellow dotted lines running parallel to your vehicle. It is designed to give you the indication on the ground of the fully extended outside mirror position.

## Front Camera

### WARNING



The front camera system still requires the driver to use it in conjunction with looking out of your vehicle.



E184044

# Parking Aids

The front video camera, located in the grille, provides a video image of the area in front of your vehicle. It adds assistance to the driver while driving forward at low speeds. To use the front video camera system, place the transmission in any gear except reverse (R). An image will display once the camera enable button is pressed. The area displayed on the screen may vary according to your vehicle's orientation and/or road condition.

## Side Camera

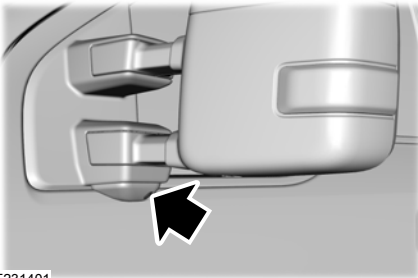

E231401

The side view camera, located in the outside mirror, provide a video image of the area on the sides of your vehicle. It aids you while parking your vehicle, or when parking with a trailer attached.

**Note:** Use caution when using the 360 view while any of the doors are ajar. If a door is ajar, the camera will be out of position and the video image may be incorrect.

## Center High-Mount Stop Lamp Camera (If Equipped)

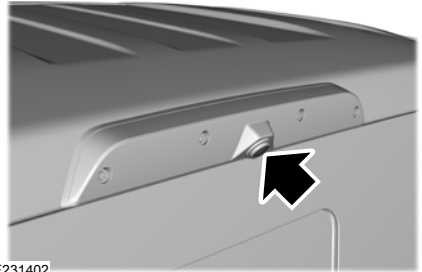

E231402

The center high-mount stop lamp camera system is a variant of the rear view camera that is mounted within the high-mount stop lamp. It is designed to display the contents of your truck bed or assist you when backing up to align and hitch a fifth wheel or gooseneck trailer. The center high-mount stop lamp camera is not meant as an alternative to the rear view camera.

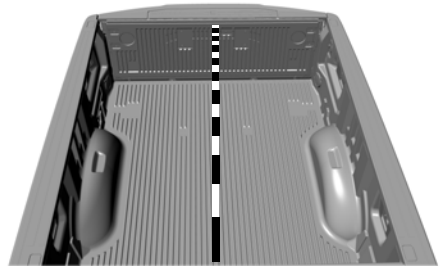

E233763

The center high-mount stop lamp camera view contains a dynamic guideline to help you locate the center of your vehicle. This view can only be accessed while in reverse (R).

# Parking Aids

---

## Auxiliary Camera (If Equipped)

**Note:** *The auxiliary camera works with trailers up to 50 ft (15 m) in length.*



Access the auxiliary camera view by pressing the button on the display screen when in reverse (R).

The auxiliary camera system is a variant of the rear view camera. It is designed to display a rear view image from the back of a trailer while reversing. The auxiliary camera is not meant as an alternative to the rear view camera.

# Cruise Control (If Equipped)

## PRINCIPLE OF OPERATION

Cruise control lets you maintain a set speed without keeping your foot on the accelerator pedal. You can use cruise control when your vehicle speed is greater than 20 mph (30 km/h).

## USING CRUISE CONTROL

### WARNINGS



Do not use cruise control on winding roads, in heavy traffic or when the road surface is slippery. This could result in loss of vehicle control, serious injury or death.



When you are going downhill, your vehicle speed could increase above the set speed. The system does not apply the brakes.

**Note:** Cruise control disengages if the vehicle speed decreases more than 10 mph (16 km/h) below the set speed when driving uphill.



E191329

The cruise controls are on the steering wheel.

### Switching Cruise Control On

Press **ON**.



The indicator appears in the information display.

### Setting the Cruise Speed

1. Drive to desired speed.
2. Press **SET+** or **SET-**.
3. Take your foot off the accelerator pedal.

**Note:** The indicator changes color.

### Changing the Set Speed

**Note:** If you accelerate by pressing the accelerator pedal, the set speed will not change. When you release the accelerator pedal, your vehicle returns to the speed that you previously set.

- Press **SET+** or **SET-** to change the set speed in small increments.
- Press the accelerator or brake pedal until you reach the desired speed. Press **SET+** or **SET-**.
- Press and hold **SET+** or **SET-**. Release the control when you reach the desired speed.

### Canceling the Set Speed

Press **CNCL** or tap the brake pedal. The set speed does not erase.

### Resuming the Set Speed

Press **RES**.

### Switching Cruise Control Off

**Note:** You erase the set speed when you switch the system off.

Press **OFF** when the system is in standby mode, or switch the ignition off.

# Cruise Control (If Equipped)

## USING ADAPTIVE CRUISE CONTROL (If Equipped)

### WARNINGS

 Always pay close attention to changing road conditions when using adaptive cruise control. The system does not replace attentive driving. Failing to pay attention to the road may result in a crash, serious injury or death.

 Do not use the adaptive cruise control when entering or leaving a highway, on roads with intersections or roundabouts or non-vehicular traffic or roads that are winding, slippery, unpaved, or steep slopes.

 Do not use the system in poor visibility, for example fog, heavy rain, spray or snow.

 Do not use the system when towing a trailer with aftermarket trailer brake controls. Aftermarket trailer brakes will not function properly when you switch the system on because the brakes are electronically controlled. Failing to do so may result in loss of vehicle control, which could result in serious injury.

 Do not use tire sizes other than those recommended because this can affect the normal operation of the system. Failure to do so may result in a loss of vehicle control, which could result in serious injury.

 Adaptive cruise control may not detect stationary or slow moving vehicles below 6 mph (10 km/h).

 Adaptive cruise control does not detect pedestrians or objects in the road.

 Adaptive cruise control does not detect oncoming vehicles in the same lane.

### WARNINGS

 Adaptive cruise control is not a crash warning or avoidance system.

 Do not use adaptive cruise control with a snow plow blade installed.

**Note:** *It is your responsibility to stay alert, drive safely and be in control of the vehicle at all times.*

The system adjusts your vehicle speed to maintain the set gap between you and the vehicle in front of you in the same lane. You can select four gap settings.

The system uses a radar sensor that projects a beam directly in front of your vehicle.



E183737

The adaptive cruise controls are on the steering wheel.

## Switching Adaptive Cruise Control On

Press **ON**.



The indicator, current gap setting and set speed appear in the information display.

# Cruise Control (If Equipped)



E233874

## Setting the Adaptive Cruise Speed

**Note:** When adaptive cruise control is active, the speedometer may vary slightly from the set speed displayed in the information display.

1. Drive to desired speed.
2. Press **SET+** or **SET-**.
3. A green indicator light, the current gap setting and your set speed appear in the information display.
4. Take your foot off the accelerator pedal.



E233874

5. A vehicle image illuminates if the system detects a vehicle in front of you.

## Following a Vehicle

### WARNINGS



When following a vehicle, your vehicle does not decelerate automatically to a stop, nor does your vehicle always decelerate quickly enough to avoid a crash without driver intervention. Always apply the brakes when necessary. Failing to do so may result in a crash, serious injury or death.



Adaptive cruise control only warns of vehicles detected by the radar sensor. In some cases there may be no warning or a delayed warning. You should always apply the brakes when necessary. Failure to do so may result in a crash, serious injury or death.

**Note:** When you are following a vehicle and you switch on a direction indicator, adaptive cruise control may provide a small temporary acceleration to help you pass.

**Note:** The brakes may emit noise when applied by the system.

When a vehicle ahead of you enters the same lane or a slower vehicle is ahead in the same lane, the vehicle speed adjusts to maintain a preset gap distance. A vehicle graphic illuminates in the instrument cluster. A vehicle graphic illuminates in the instrument cluster.

Your vehicle maintains a consistent gap from the vehicle ahead until:

- The vehicle in front of you accelerates to a speed above the set speed.
- The vehicle in front of you moves out of the lane you are in.
- You set a new gap distance.

The system applies the brakes to slow your vehicle to maintain a safe gap distance from the vehicle in front. The system only applies limited braking. You can override the system by applying the brakes.



## Cruise Control (If Equipped)

If the system determines that its maximum braking level will not be sufficient, an audible warning sounds when the system continues to brake. A red warning bar displays on the windshield and you must take immediate action.

### Setting the Gap Distance

**Note:** The gap setting is time dependent and therefore the distance adjusts with your vehicle speed.

**Note:** It is your responsibility to select a gap appropriate to the driving conditions.

You can decrease or increase the distance between your vehicle and the vehicle in front by pressing the gap control.

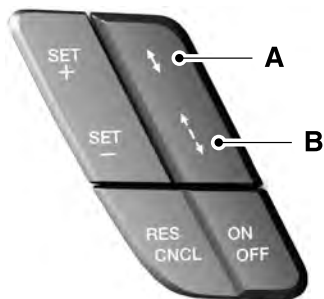

E183739

- A Gap decrease.
- B Gap increase.



E233874

The selected gap appears in the information display as shown by the bars in the image.

### Adaptive Cruise Control Gap Settings

Graphic display, bars indicated between vehicles	Dynamic behavior
1	Sport.
2	Normal.
3	Normal.
4	Comfort.

Each time you switch the system on, it selects the last chosen gap setting.

### Overriding the Set Speed

#### WARNING



If you override the system by pressing the accelerator pedal, it does not automatically apply the brakes to maintain a gap from any vehicle ahead.

When you press the accelerator pedal, you override the set speed and gap distance.



When you override the system, the green indicator light illuminates and the vehicle image does not appear in the information display.

The system resumes operation when you release the accelerator pedal. The vehicle speed decreases to the set speed, or a lower speed if following a slower vehicle.

# Cruise Control (If Equipped)

## Changing the Set Speed

- Press **SET+** or **SET-** to change the set speed in small increments.
- Press the accelerator or brake pedal until you reach the desired speed. Press **SET+** or **SET-**.
- Press and hold **SET+** or **SET-** to change the set speed in large increments. Release the control when you reach the desired speed.

The system may apply the brakes to slow the vehicle to the new set speed. The set speed displays continuously in the information display when the system is active.

## Canceling the Set Speed

Press **CNCL** or tap the brake pedal. The set speed does not erase.

## Resuming the Set Speed

**Note:** Only use resume if you are aware of the set speed and intend to return to it.

Press **RES**. Your vehicle speed returns to the previously set speed and gap setting. The set speed displays continuously in the information display when the system is active.

## Automatic Cancellation

**Note:** If the engine speed drops too low, an audible warning sounds and a message appears in the information display. Automatic braking releases.

## Hilly Condition and Trailer Tow Usage

**Note:** An audible alarm sounds and the system shuts down if it applies brakes for an extended period of time. This allows the brakes to cool. The system functions normally again after the brakes cool.

**Note:** When towing with adaptive cruise control, switch on *Tow/Haul Mode* and *Diesel Engine Brake*.

**Note:** *Tow/Haul mode increases the time gaps and allows more distance for braking.*

Select a lower gear when the system is active in situations such as prolonged downhill driving on steep grades, for example in mountainous areas. The system needs additional engine braking in these situations to reduce the load on the vehicle's regular brake system to prevent it from overheating.

## Switching Adaptive Cruise Control Off

**Note:** You erase the set speed and gap setting when you switch the system off.

Press **OFF** when the system is in standby mode, or switch the ignition off.

## Detection Issues

### WARNINGS



On rare occasions, detection issues can occur due to the road infrastructures, for example bridges, tunnels and safety barriers. In these cases, the system may brake late or unexpectedly. At all times, you are responsible for controlling your vehicle, supervising the system and intervening, if required.



If the system malfunctions, have your vehicle checked as soon as possible.

The radar sensor has a limited field of view. It may not detect vehicles at all or detect a vehicle later than expected in some situations. The lead vehicle graphic does not illuminate if the system does not detect a vehicle in front of you.

# Cruise Control (If Equipped)

A

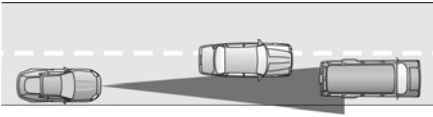

B



C

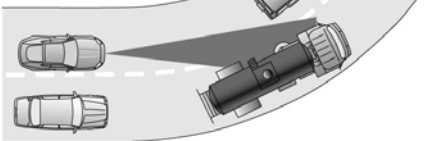

E71621

Detection issues can occur:

- When driving on a different line than the vehicle in front.
- With vehicles that edge into your lane. The system can only detect these vehicles once they move fully into your lane.
- There may be issues with the detection of vehicles in front when driving into and coming out of a bend or curve in the road.

In these cases, the system may brake late or unexpectedly. You should stay alert and take action when necessary.

If something hits the front end of your vehicle or damage occurs, the radar-sensing zone may change. This could cause missed or false vehicle detection.

## System Not Available

**Note:** If you disable electronic stability control, adaptive cruise control is not available.

The system may not turn on if there is:

- A blocked sensor.
- High brake temperature.
- A failure in the system or a related system.

## Blocked Sensor



E183741

**Note:** You cannot see the sensor. It is behind a fascia panel.

A message displays if something obstructs the radar signals from the sensor. The sensor is in the lower grille. The system cannot detect a vehicle ahead and does not function when something blocks the sensor.

# Cruise Control (If Equipped)

## Possible Causes and Actions for This Message Displaying:

Cause	Action
The surface of the radar is dirty or obstructed.	Clean the grille surface in front of the radar or remove the object causing the obstruction.
The surface of the radar is clean but the message remains in the display.	Wait a short time. It may take several minutes for the radar to detect that it is free from obstruction.
Heavy rain or snow is interfering with the radar signals.	Do not use the system in these conditions because it may not detect any vehicles ahead.
Water, snow or ice on the surface of the road may interfere with the radar signals.	Do not use the system in these conditions because it may not detect any vehicles ahead.
You are in a desert or remote area with no other vehicles and no roadside objects.	Wait a short time or switch to normal cruise control.

Due to the nature of radar technology, it is possible to get a blockage warning with no actual block. This happens, for example, when driving in sparse rural or desert environments. A false blocked condition either self clears, or clears after you restart your vehicle.

## Switching to Normal Cruise Control

### WARNING



Normal cruise control will not brake when your vehicle is approaching slower vehicles. Always be aware of which mode you have selected and apply the brakes when necessary.



The cruise control indicator light replaces the adaptive cruise control indicator light if you select normal cruise control. The gap setting does not display, and the system does not respond to lead vehicles. Automatic braking remains active to maintain set speed.

You can change from adaptive cruise control to normal cruise control through the information display.

# Driving Aids

## LANE KEEPING SYSTEM (If

Equipped)

### WARNING



The system is designed to aid the driver. It is not intended to replace your attention and judgment. You are still responsible to drive with due care and attention.

**Note:** The system works as long as the camera can detect one lane marking at a speed above 40 mph (64 km/h).

**Note:** The system may not function if the camera is blocked or there is damage to the windshield.

The Lane Keeping System automatically detects and tracks the road lane markings using a camera mounted behind the interior review view mirror. The system notifies you to stay in your lane when the front camera detects an unintentional lane change is likely to occur.

### Switching the System On and Off

**Note:** The system on or off setting is stored until it is manually changed, unless a MyKey is detected. If the system detects a MyKey, it defaults to on and the mode is set to alert.

**Note:** If a MyKey is detected, pressing the button will not affect the on or off status of the system. You can only change the mode and intensity settings.



Press the button located on the center console to switch the system on or off.

## System Settings

The system sensitivity and intensity can be adjusted through the display screen. See **General Information** (page 113). The system remembers the last selection. You do not need to readjust the setting each time you turn on your vehicle.

**Sensitivity:** This setting allows you to select where in the lane a warning is provided. Increasing the sensitivity setting moves the warning zones in closer to your vehicle.

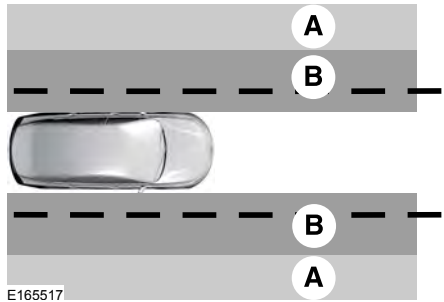

- A Normal
- B Increased

**Note:** The alert diagram illustrates general zone coverage. It does not provide exact zone parameters.

**Intensity:** This setting affects the intensity of the steering wheel vibration. Increasing the intensity causes a higher rate of haptic feedback.

- High
- Normal
- Low

# Driving Aids

## System Display



E233874

When you switch on the system, an overhead graphic of a vehicle with lane markings appears in the display screen.

**Note:** *The overhead vehicle graphic may still display if adaptive cruise control is enabled.*

While the system is on, the color of the lane markings change to indicate the system status.

**Gray:** Indicates that the system is temporarily unable to provide a warning on the indicated side(s). This may be because:

- Your vehicle is under the activation speed.
- Your turn indicator is active.

- Your vehicle is in a dynamic maneuver.
- The road has no or poor lane markings in the camera field-of-view.
- The camera is obscured or unable to detect the lane markings due to environmental conditions (significant sun angles, shadows, snow, heavy rain, fog), traffic conditions (following a large vehicle that is blocking or shadowing the lane), or vehicle conditions (poor headlamp illumination).

See **Troubleshooting** for additional information.

**Green:** Indicates that the system is available or ready to provide a warning on the indicated side(s).

**Red:** Indicates that the system is providing or has just provided a lane keeping alert warning.

You can temporarily disable the system at any time by doing the following:

- Quick braking.
- Fast acceleration.
- Using your direction indicator.
- Evasive steering maneuver.

## Troubleshooting

<b>Why is the feature not available (lane markings are gray) when I can see the lane markings on the road?</b>
Vehicle speed is outside the operational range of the feature
Sun is shining directly into the camera lens
Quick intentional lane change
Staying too close to the lane marking
Driving at high speeds in curves

# Driving Aids

## Why is the feature not available (line markings are gray) when I can see the lane markings on the road?

Previous feature activation happened within the last one second
Ambiguous lane markings (mainly in construction zones)
Rapid transition from light to dark or vice versa
Sudden offset in lane markings
ABS or AdvanceTrac activation
Camera blockage due to dirt, grime, fog, frost or water on the windshield
Driving too close to the vehicle in front of you
Transitioning between no lane markings to lane markings or vice versa
Standing water on the road
Faint lane markings (partial yellow lane markings on concrete roads)
Lane width too narrow or too wide
Camera not calibrated after a windshield replacement
Driving on tight roads or on uneven roads
Vehicle accessories such as snow plows

## BLIND SPOT INFORMATION SYSTEM (If Equipped)

### WARNING



Do not use the blind spot information system as a replacement for using the interior and exterior mirrors or looking over your shoulder before changing lanes. The blind spot information system is not a replacement for careful driving.

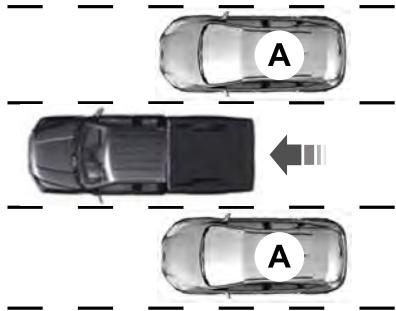

E227388

# Driving Aids

The Blind Spot Information System is designed to aid you in detecting vehicles that may have entered the blind spot zone (A). The detection area is on both sides of your vehicle, extending rearward from the exterior mirrors to approximately 13 ft (4 m) beyond the bumper. The system is designed to alert you if certain vehicles enter the blind spot zone while driving.

**Note:** *The Blind Spot Information System does not prevent contact with other vehicles or objects; nor detect parked vehicles, people, animals or infrastructure (fences, guardrails, trees). It is only designed to alert you to moving vehicles in the blind spot zones.*

**Note:** *When a vehicle passes quickly through the blind spot zone, typically fewer than two seconds, the system does not trigger.*

## Using the System

The Blind Spot Information System turns on when you start the engine and you drive your vehicle forward above 5 mph (8 km/h).

For automatic transmissions, the Blind Spot Information System remains on while the transmission is in drive (D). If shifted into reverse (R) or park (P) the Blind Spot Information System turns off. Once shifted back into drive (D), the Blind Spot Information System turns back on when you drive your vehicle above 5 mph (8 km/h).

**Note:** *For automatic transmissions, the Blind Spot Information System does not function in reverse (R) or park (P).*

For manual transmissions, the Blind Spot Information System is on for all gears except reverse (R).

## System Lights and Messages



E142442

The Blind Spot Information System illuminates an amber alert indicator in the outside mirror on the side of your vehicle the approaching vehicle is coming from. When the Blind Spot Information System is alerting on a vehicle and the corresponding turn signal is ON, the Blind Spot Information System alert indicator flashes as an increased warning level.

The alert indicator dims when the system detects nighttime darkness.

**Note:** *The alert indicator flashes in case of an alert and the turn signal is set to that side at the same time.*

## System Sensor Blockage



E231384



# Driving Aids

The system uses radar sensors that are located inside the tail lamp on each side of your vehicle. Any dirt, mud and snow in front of the sensors or driving in heavy rain can cause system degradation. Also, other types of obstructions in front of the sensor can cause system degradation. This is referred to as a 'blocked' condition.

**Note:** Do not apply bumper stickers and/or repair compound to these areas, this can cause degraded system performance.

If the system detects a degraded performance condition, a message warning appears in the display screen. The alert indicators remain ON and the system no longer provides any warnings. You can clear the warning but the alert indicators remain illuminated.

A "blocked" condition can be cleared in two ways:

- After the blockage in front of the sensors is removed or the rainfall/snowfall rate decreases or stops, drive for a few minutes in traffic to allow the sensors to detect passing vehicles.
- By cycling the ignition from ON to OFF and then back ON.

**Note:** If your vehicle has a tow bar with a factory equipped trailer tow module and it is towing a trailer, the sensors will automatically turn the Blind Spot Information System off. If your vehicle has a tow bar but no factory equipped trailer tow module, it is recommended to turn the Blind Spot Information System off manually. Operating the Blind Spot Information System without the Blind Spot Trailer Tow package and a trailer attached will cause poor system performance.

## Blind Spot Information System with Trailer Tow (If Equipped)

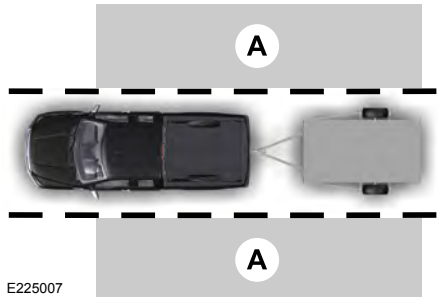

The Blind Spot Information System with Trailer Tow is designed to aid you in detecting vehicles that may have entered the detection area zone (A). The detection area is on both sides of your vehicle and trailer, extending rearward from the exterior mirrors to the end of your trailer.

When a trailer is attached and the customer has set up a Blind Spot Trailer, the Blind Spot Information System with Trailer Tow becomes active when driving forward above 6 mph (10 km/h). See **Trailer Reversing Aids** (page 274).

The Blind Spot Information System with Trailer Tow can be turned off in the instrument cluster. If the Blind Spot Information System is turned off, then the Blind Spot Information System with Trailer Tow automatically turns off.

# Driving Aids

## Setting up a Blind Spot Trailer

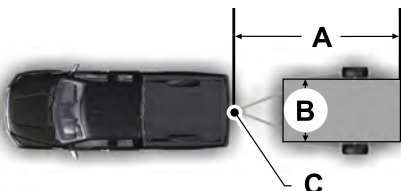

E225008

- A Trailer length
- B Trailer width
- C Trailer hitch ball

You can set-up any trailer to work with the Blind Spot Information System with Trailer Tow through the instrument cluster menu. See **General Information** (page 113). While setting up a trailer, a sequence of screens appear asking for trailer information. The Blind Spot Information System with Trailer Tow specific screens are described below:

- Select type of trailer screen - Conventional, fifth wheel or gooseneck.

The Blind Spot Information System with Trailer Tow only supports conventional trailers. If fifth wheel or gooseneck is selected, the system automatically turns off.

- Do you want to set up BLIS with trailer screen?

If no, the Blind Spot Information System turns off.

If yes, the menu goes to the next screen.

- Is the width less than 9 ft (2.7 m) and length less than 33 ft (10.1 m)?

If no, the Blind Spot Information System turns off.

If yes, the menu goes to the next screen.

- Trailer width measurement:

The width of the trailer is measured at the front of the trailer. It is not measured at the widest point of the trailer. The maximum width at the front of the trailer that the Blind Spot Information System with Trailer Tow can support is 8.5 ft (2.6 m).

**Note:** You do not need to enter an exact trailer width measurement; just measure that it is 8.5 ft (2.6 m) or less.

- Trailer length measurement:

The trailer length is the distance between the trailer hitch ball and the rear of the trailer. The maximum length that the Blind Spot Information System with Trailer Tow can support is 33 ft (10.1 m).

- Enter length of trailer:

The default setting is 18 ft (5.5 m). Toggling up or down using the menu buttons will increase/decrease the measurement by 3 ft (1 m). Select the length so that the value is equal to or within 3 ft (1 m) of the actual measured length. For example, if the actual measured length is 25 ft (7.6 m), then toggle the length in the menu to 27 ft (8.2 m). When the length has been entered, the Blind Spot Information System with Trailer Tow setup is saved.

If you do not set up a Blind Spot Trailer, a warning appears in the instrument cluster when a trailer is connected stating that the system has been turned off due to a trailer connect.

**Note:** If the trailer is actually a bike rack or cargo rack with electrical lighting, then the length will be 3 ft (1 m). Cross Traffic Alert will remain on for trailers 3 ft (1 m) or less.

**Note:** Proper measurement and measurement entry is required for Blind Spot Information System with Trailer Tow to function as designed.

# Driving Aids

---

## System Operation

If you select a trailer in the display screen prior to connecting the trailer, the system will load that configuration and the information cluster displays a message when the trailer is connected. A second message appears stating Cross Traffic Alert has been turned off; the Blind Spot Information System with Trailer Tow still functions normally when driving forward.

If no trailer has been set up and a trailer is connected, the instrument cluster provides a message indicating a trailer is connected followed by a message asking to select a trailer from the existing list of trailers or to add a trailer. In order for the Blind Spot Information System with Trailer Tow to function, an existing trailer must be selected or a new trailer must be added. If the request is ignored or if you exit the screen, a message appears prompting you that the system has been turned off due to a trailer connect. This message may not appear until your vehicle speed reaches 22 mph (35 km/h).

The Blind Spot Information System with Trailer Tow activates when driving forward for that particular trailer set up. If the ignition is cycled, the Blind Spot Information System with Trailer Tow continues to function using the last trailer selected.

## Trailer Considerations

The Blind Spot Information System with Trailer Tow is designed to work with any trailer whose front width is 8.5 ft (2.6 m) or less and total length from the trailer hitch ball to the rear of the trailer is 33 ft (10.1 m) or less. Different trailers may cause a slight change in performance as outlined below.

Large box trailers may cause false alerts to trigger when driving next to buildings or near parking cars. A false alert may also occur while making a 90-degree turn.

Trailers that are 8.5 ft (2.6 m) wide at the front and have a total length greater than 20 ft (6 m) may have delayed alerts from passing vehicles when the vehicle is passing at high speed.

A box trailer whose front width is 8.5 ft (2.6 m) may cause early alerts when you are overtaking a vehicle.

When towing a clam shell or V-Nose box trailer with a front width of 8.5 ft (2.6 m), delayed alerts on merging vehicles that are traveling the same speed as your vehicle may occur.

## System Errors

If the system senses a problem with the left or right sensor, the telltale illuminates and a message appears in the display screen. See **Information Messages** (page 129).

## Switching the System Off and On

You can temporarily switch the Blind Spot Information System off in the display screen. See **General Information** (page 113). When the Blind Spot Information System switches off, you do not receive alerts and the display screen shows a system off message. The telltale in the cluster also illuminates. When you switch the Blind Spot Information System on or off, the alert indicators flash twice.

**Note:** *The Blind Spot Information System remembers the last selected on or off setting.*

You can also have the Blind Spot Information System switched off permanently at an authorized dealer. Once switched off permanently, the system can only be switched back on at an authorized dealer.

# Driving Aids

## CROSS TRAFFIC ALERT (if

Equipped)

### WARNING



Do not use the cross traffic alert system as a replacement for using the interior and exterior mirrors or looking over your shoulder before reversing out of a parking space. The cross traffic alert system is not a replacement for careful driving.

**Note:** When a trailer is detected, Cross Traffic Alert automatically turns off.

Cross Traffic Alert is designed to warn you of vehicles approaching from the sides when the transmission is in reverse (R).

## Using the System

Cross Traffic Alert turns on when you start the engine and you shift into reverse (R). Once shifted out of reverse (R), Cross Traffic Alert turns off.

Cross Traffic Alert is designed to detect vehicles that approach the rear of your vehicle with a speed up to 37 mph (60 km/h). Coverage decreases when the sensors are partially, mostly or fully obstructed. Reversing slowly helps increase the coverage area and effectiveness.

In this first example, the left sensor is only partially obstructed; zone coverage to the right is nearly maximized.

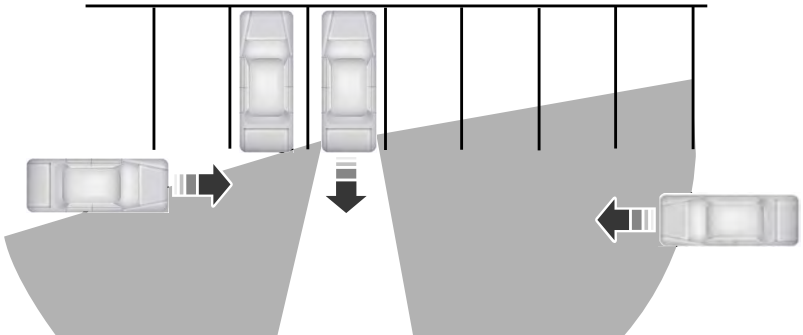

E142440

Zone coverage also decreases when parking at shallow angles. Here, the left sensor is mostly obstructed; zone coverage on that side is severely limited.

# Driving Aids

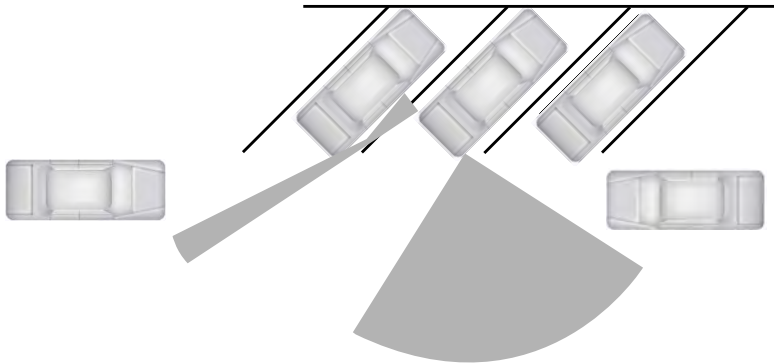

E142441

## System Lights, Messages and Audible Alerts



E142442

The Cross Traffic Alert illuminates an amber alert indicator in the outside mirror on the side of your vehicle the approaching vehicle is coming from. Cross Traffic Alert also sounds an audible alert and a message appears in the display screen indicating a vehicle is coming from the right or left. Cross Traffic Alert works with the reverse sensing system that sounds its own series of tones. See **Rear Parking Aid** (page 235).

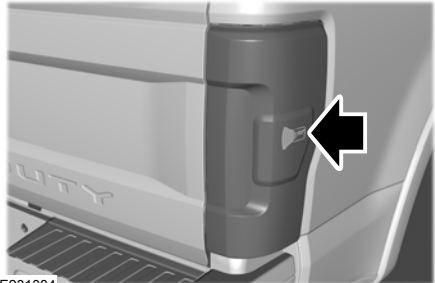

E231384

The system uses radar sensors that are located in the tail lamp on each side of your vehicle. Do not allow mud, snow or bumper stickers to obstruct these areas, this can cause degraded system performance. See **Blind Spot Information System** (page 252). If the Blind Spot Information System is blocked, Cross Traffic Alert is also blocked. A Cross Traffic Alert blocked message appears in the display screen when the transmission is shifted into reverse (R).

# Driving Aids

## System Limitations

Cross Traffic Alert has its limitations; situations such as severe weather conditions or debris build-up on the sensor area may limit vehicle detection and cause false alerts.

The following are other situations that may limit the Cross Traffic Alert performance:

- Adjacently parked vehicles or objects obstructing the sensors.
- Approaching vehicles passing at speeds greater than 37 mph (60 km/h).
- Driving in reverse faster than 7 mph (12 km/h).
- Backing out of an angled parking spot.

## False Alerts

**Note:** *If your vehicle has a tow bar with a factory equipped trailer tow module and it is towing a trailer, the sensors will automatically turn the Cross Traffic Alert off. If your vehicle has a tow bar but no factory equipped trailer tow module, it is recommended to turn the Cross Traffic Alert off manually. Operating Cross Traffic Alert with a trailer attached will cause poor Cross Traffic Alert performance.*

**Note:** *The system may illuminate the amber alert indicator and sound the audible alert during heavy rain even though no vehicle is approaching from left or right.*

There may be certain instances when there is a false alert by the Cross Traffic Alert system that illuminates the alert indicator with no vehicle in the coverage zone. Some amount of false alerts are normal; they are temporary and self-correct.

## System Errors

If Cross Traffic Alert senses a problem with the left or right sensor a message appears in the display screen. See **Information Messages** (page 129).

## Switching the System Off and On

**Note:** *The Cross Traffic Alert switches on whenever the ignition is switched on and ready to provide appropriate alerts when the transmission is in reverse (R). Cross Traffic Alert will not remember the last selected on or off setting.*

You can temporarily switch Cross Traffic Alert off in the information display. See **General Information** (page 113). When you switch Cross Traffic Alert off, you do not receive alerts and the display screen shows a system off message.

You can also have Cross Traffic Alert switched off permanently at an authorized dealer. Once switched off permanently, the system can only be switched back on at an authorized dealer.

## STEERING

### Power Steering

To help prevent damage to the power steering system:

- Never hold the steering wheel at its furthest turning points (until it stops) for more than three seconds when the engine is running.
- Do not operate the vehicle with a low power steering pump fluid level (below the MIN mark on the reservoir).
- Some noise is normal during operation. If excessive, check for low power steering pump fluid level before seeking service by your dealer.

## Driving Aids

---

- Heavy or uneven efforts may be caused by low power steering fluid. Check for low power steering pump fluid level before seeking service by your dealer.
- Do not fill the power steering pump reservoir above the MAX mark on the reservoir, as this may result in leaks from the reservoir.

If the power steering system breaks down (or if the engine is turned off), you can steer the vehicle manually, but it takes more effort.

If the steering wanders or pulls, check for:

- an improperly inflated tire
- uneven tire wear
- loose or worn suspension components
- loose or worn steering components
- improper vehicle alignment

If any steering components are serviced or replaced, install new fasteners (many are coated with thread adhesive or have prevailing torque features which may not be re-used). Never re-use a bolt or nut. Torque fasteners to specifications.

A high crown in the road or high crosswinds may also make the steering seem to wander or pull.

### Adaptive Steering (If Equipped)

**Note:** The adaptive steering system has diagnostic checks that continuously monitor the system. If a fault is detected a message displays in the information display. If a red warning message displays, stop your vehicle as soon as it is safe to do so. The message may clear if the fault is no longer present. If an adaptive steering system warning message appears each time you start your vehicle, have the system checked as soon as possible.

The adaptive steering system continually changes the steering ratio with changes to vehicle speed, optimizing the steering response in all conditions. The system also changes when you switch on the transmission tow/haul feature. When you select the tow/haul button, the adaptive steering system reduces vehicle sensitivity to steering inputs at higher vehicle speeds, while maintaining the ease of parking and maneuverability at low speeds.

**Note:** The adaptive steering system is designed with a locking device. With the lock engaged, the adaptive steering system remains mechanically locked at a fixed steering ratio. You may also notice a click when you switch the vehicle on or after you switch it off, as the lock disengages or engages.

**Note:** If your vehicle loses electrical power or detects a fault when you are driving, the system automatically shuts down and you retain normal steering function with a fixed steering ratio. During this time it is possible that the steering wheel may not be straight when the vehicle is driving straight ahead. In addition, the driver may notice that the steering wheel angle required to steer the vehicle may be different.

**Note:** During parking maneuvers, the adaptive steering system balances the driver work load for various steering wheel inputs and vehicle loading conditions. Under extreme operating conditions the system locking device may engage. This strategy prevents overheating and permanent damage to the adaptive steering system. Typical steering and driving maneuvers allow the system to cool and return to normal operation.

# Driving Aids

## COLLISION WARNING SYSTEM

(If Equipped)

### Principle Of Operation (If Equipped)

#### WARNINGS



This system is an extra driving aid. It does not replace your attention and judgment, or the need to apply the brakes. This system does NOT automatically brake your vehicle. If you fail to press the brake pedal when necessary, you may collide with another vehicle.



The collision warning system with brake support cannot help prevent all collisions. Do not rely on this system to replace your judgment and the need to maintain correct distance and speed.

**Note:** The system does not detect, warn or respond to potential collisions with vehicles to the rear or sides of your vehicle.

**Note:** The collision warning system is active at speeds above approximately 5 mph (8 km/h).

**Note:** The collision warning system will be unavailable if you disable the electronic stability control. See **Using Stability Control** (page 231).



E156130

The system alerts you of certain collision risks. The system's sensor detects your vehicle's rapid approach to other vehicles traveling in the same direction as your vehicle.

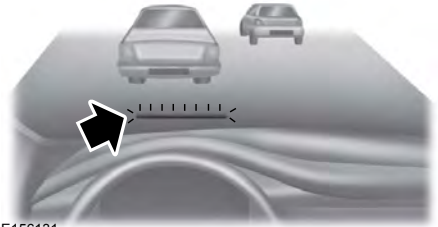

E156131

When your vehicle rapidly approaches another vehicle, a red warning light flashes and a tone sounds.

The brake support system assists you in reducing any collision speed by pre-charging the brakes. If the risk of collision continues to increase after the audio-visual warning, the brake support prepares the brake system for rapid braking. The system does not automatically activate the brakes, but if the brake pedal is pressed even lightly, the brakes apply full stopping power.

### Using the Collision Warning System

#### WARNING



The collision warning system's brake support reduces collision speed only if you brake your vehicle before any collision. As in any typical braking situation, you must press your brake pedal.

You can use your information display control to adjust the collision warning system's sensitivity or to turn the system On or Off. Your vehicle will remember these settings across key cycles. You may change the collision warning system sensitivity to any one of three possible settings. See **General Information** (page 113).



# Driving Aids

**Note:** It is recommended that you turn the collision warning system off if a snow plow or similar object is installed in such a way that it may block the radar sensor. Your vehicle will remember the selected setting across key cycles.

**Note:** When possible, the manufacturer recommends using the highest sensitivity setting. If warnings are too frequent, you can reduce your system's sensitivity. Reduced sensitivity causes fewer and later system warnings. See **General Information** (page 113).

## Blocked Sensors

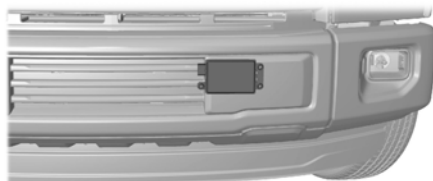

E183741

If a blocked sensor message appears in the information display, dirt, water, or an object is blocking the sensor. The sensor is located behind a cover near the driver side of the lower grille. If anything blocks the sensor, your vehicle cannot see through the sensor, and the collision warning system will not work. Possible causes for the blocked sensor message and corrective actions are listed below.

Cause	Action
The radar sensor cover in the grille is dirty or obstructed	Clean the radar sensor cover or remove the obstruction
The surface of the radar sensor cover is clean but the message remains in the display	Wait a short time. The radar may take several minutes to reset after you remove the obstruction
Heavy rain, spray, snow or fog in the air interferes with the radar signals	The collision warning system is temporarily disabled. Shortly after weather conditions improve, the collision warning system automatically reactivates
Swirling water, snow or ice on the road surface interferes with the radar signals	The collision warning system is temporarily disabled. Shortly after weather conditions improve, the collision warning system automatically reactivates

## System Limitations

### WARNING



The collision warning system's brake support only reduces collision speed if you first apply your brakes. You must brake as you would in any typical braking situation.

---

Due to the nature of radar technology, there may be certain instances where vehicles do not provide a collision warning. These include:

- Stationary vehicles or vehicles moving below 6 mph (10 km/h).
- Pedestrians or objects in the roadway.
- Oncoming vehicles in the same lane.
- Severe weather conditions (see blocked sensor section).
- Debris build-up on the grille near the headlamps (see blocked sensor section).
- Small distance to vehicle ahead.
- Large steering wheel and pedal movements (very active driving style).

Damage to the front end of your vehicle may alter the radar sensor's coverage area. This may result in missed or false collision warnings. Have an authorized dealer check your radar sensor for proper coverage and operation.

# Load Carrying

## LOAD LIMIT

### Vehicle Loading - with and without a Trailer

This section guides you in the proper loading of your vehicle, trailer, or both. Keep your loaded vehicle weight within its design rating capability, with or without a trailer. Properly loading your vehicle provides maximum return of vehicle design performance. Before you load your vehicle, become familiar with the following terms for determining your vehicle's weight rating, with or without a trailer, from the vehicle's Tire and Loading Information label or Safety Compliance Certification label.

### Tire and Loading Label Information Example:

**TIRE AND LOADING INFORMATION**

SEATING CAPACITY TOTAL: 5 FRONT: 2 REAR: 3

The combined weight of occupants and cargo should never exceed: **385 kg or 850 lbs.**

TIRE	SIZE	COLD TIRE PRESSURE
FRONT	235/45R18 94V	235 KPA, 34 PSI
REAR	235/45R18 94V	235 KPA, 34 PSI
SPARE	NONE	NONE

**SEE OWNERS MANUAL FOR ADDITIONAL INFORMATION**

**TIRE AND LOADING INFORMATION**  
**RENSEIGNEMENTS SUR LES PNEUS ET LE CHARGEMENT**

SEATING CAPACITY / NOMBRE DE PLACES TOTAL 5 FRONT AVANT 2 REAR ARRIERE 3

The combined weight of occupants and cargo should never exceed 396 kg or 875 lbs.  
Le poids total des occupants et du chargement ne doit jamais dépasser 396 kg ou 875 lb.

TIRE / PNEU	SIZE / DIMENSIONS	COLD TIRE PRESSURE / PRESSION DES PNEUS A FROID
FRONT AVANT	235/40R19 96V	255 KPA, 37 PSI
REAR ARRIERE	235/40R19 96V	255 KPA, 37 PSI
SPARE DE SECOURS	T125/80R16 97M	415 KPA, 60 PSI

**SEE OWNER'S MANUAL FOR ADDITIONAL INFORMATION**  
**VOIR LE MANUEL DE L'USAGER POUR PLUS DE RENSEIGNEMENTS**

E198719

## Payload

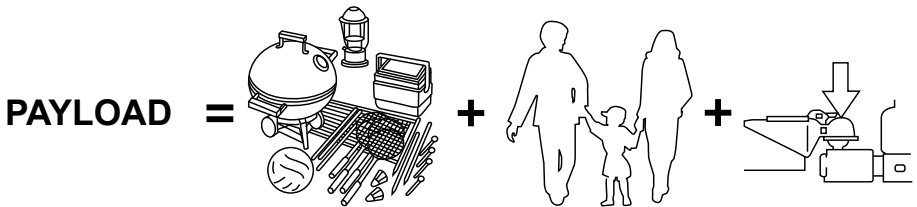

E143816

# Load Carrying

---

Payload is the combined weight of cargo and passengers that your vehicle is carrying. The maximum payload for your vehicle appears on the Tire and Loading label. The label is either on the B-pillar or the edge of the driver door. Vehicles exported outside the US and Canada may not have a tire and loading label. Look for “The combined weight of occupants and cargo should never exceed XXX kg OR XXX lb” for maximum payload. The payload listed on the Tire and Loading Information label is the maximum payload for your vehicle as built by the assembly plant. If you install any additional equipment on your vehicle, you must determine the new payload. Subtract the weight of the equipment from the payload listed on the Tire and Loading label. When towing, trailer tongue weight or king pin weight is also part of payload.

## **WARNING**



The appropriate loading capacity of your vehicle can be limited either by volume capacity (how much space is available) or by payload capacity (how much weight the vehicle should carry). Once you have reached the maximum payload of your vehicle, do not add more cargo, even if there is space available. Overloading or improperly loading your vehicle can contribute to loss of vehicle control and vehicle rollover.

---

## **GAWR (Gross Axle Weight Rating)**

GAWR is the maximum allowable weight that a single axle (front or rear) can carry. These numbers are on the Safety Compliance Certification label. The label is located on the door hinge pillar, door-latch post, or the door edge that meets the door-latch post, next to the driver seating position.

The total load on each axle must never exceed its Gross Axle Weight Rating.

## **GVWR (Gross Vehicle Weight Rating)**

GVWR is the maximum allowable weight of the fully loaded vehicle. This includes all options, equipment, passengers and cargo. It appears on the Safety Compliance Certification label. The label is located on the door hinge pillar, door-latch post, or the door edge that meets the door-latch post, next to the driver seating position.

The gross vehicle weight must never exceed the Gross Vehicle Weight Rating.

# Load Carrying

## Safety Compliance Certification Label Example:

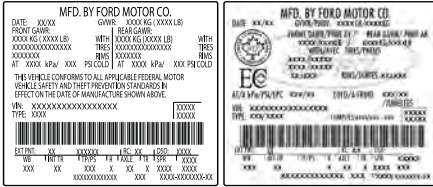

©198828

## WARNING



Exceeding the Safety Compliance Certification label vehicle weight rating limits could result in substandard vehicle handling or performance, engine, transmission and/or structural damage, serious damage to the vehicle, loss of control and personal injury.

## Maximum Loaded Trailer Weight

Maximum loaded trailer weight is the highest possible weight of a fully loaded trailer the vehicle can tow. Consult an authorized dealer (or the RV and Trailer Towing Guide available at an authorized dealer) for more detailed information.

## GCWR (Gross Combined Weight Rating)

GCWR is the maximum allowable weight of the vehicle and the loaded trailer, including all cargo and passengers, that the vehicle can handle without risking damage. (Important: The towing vehicle's braking system is rated for operation at Gross Vehicle Weight Rating, not at Gross Combined Weight Rating.) Separate functional brakes should be used for safe control of towed vehicles and for trailers where the Gross Combined Weight of the towing vehicle plus the trailer exceed the Gross Vehicle Weight Rating of the towing vehicle.

The gross combined weight must never exceed the Gross Combined Weight Rating.

**Note:** For trailer towing information refer to the RV and Trailer Towing Guide available at an authorized dealer.

## WARNINGS



Do not exceed the GVWR or the GAWR specified on the Safety Compliance Certification label.

# Load Carrying

## WARNINGS



Do not use replacement tires with lower load carrying capacities than the original tires because they may lower your vehicle's GVWR and GAWR limitations. Replacement tires with a higher limit than the original tires do not increase the GVWR and GAWR limitations.



Exceeding any vehicle weight rating limitation could result in serious damage to your vehicle, personal injury or both.

## Steps for determining the correct load limit:

1. Locate the statement "The combined weight of occupants and cargo should never exceed XXX kg or XXX lb." on your vehicle's placard.
2. Determine the combined weight of the driver and passengers that will be riding in your vehicle.
3. Subtract the combined weight of the driver and passengers from XXX kg or XXX lb.

4. The resulting figure equals the available amount of cargo and luggage load capacity. For example, if the "XXX" amount equals 1,400 lb. and there will be five 150 lb. passengers in your vehicle, the amount of available cargo and luggage load capacity is 650 lb.  $(1400 - 750 (5 \times 150) = 650 \text{ lb.})$
5. Determine the combined weight of luggage and cargo being loaded on the vehicle. That weight may not safely exceed the available cargo and luggage load capacity calculated in Step 4.
6. If your vehicle will be towing a trailer, load from your trailer will be transferred to your vehicle. Consult this manual to determine how this reduces the available cargo and luggage load capacity of your vehicle.

## ***Helpful examples for calculating the available amount of cargo and luggage load capacity***

Suppose your vehicle has a 1400-pound (635-kilogram) cargo and luggage capacity. You decide to go golfing. Is there enough load capacity to carry you, four of your friends and all the golf bags? You and four friends average 220 pounds (99 kilograms) each and the golf bags weigh approximately 30 pounds (13.5 kilograms) each. The calculation would be:  $1400 - (5 \times 220) - (5 \times 30) = 1400 - 1100 - 150 = 150$  pounds. Yes, you have

## Load Carrying

enough load capacity in your vehicle to transport four friends and your golf bags. In metric units, the calculation would be:  $635 \text{ kilograms} - (5 \times 99 \text{ kilograms}) - (5 \times 13.5 \text{ kilograms}) = 635 - 495 - 67.5 = 72.5 \text{ kilograms}$ .

Suppose your vehicle has a 1400-pound (635-kilogram) cargo and luggage capacity. You and one of your friends decide to pick up cement from the local home improvement store to finish that patio you have been planning for the past two years. Measuring the inside of the vehicle with the rear seat folded down, you have room for twelve 100-pound (45-kilogram) bags of cement. Do you have enough load capacity to transport the cement to your home? If you and your friend each weigh 220 pounds (99 kilograms), the calculation would be:  $1400 - (2 \times 220) - (12 \times 100) = 1400 - 440 - 1200 = -240 \text{ pounds}$ . No, you do not have enough cargo capacity to carry that much weight. In metric units, the calculation would be:  $635 \text{ kilograms} - (2 \times 99 \text{ kilograms}) - (12 \times 45 \text{ kilograms}) = 635 - 198 - 540 = -103 \text{ kilograms}$ . You will need to reduce the load weight by at least 240 pounds (104 kilograms). If you remove three 100-pound (45-kilogram) cement bags, then the load calculation would be:  $1400 - (2 \times 220) - (9 \times 100) = 1400 - 440 - 900 = 60 \text{ pounds}$ . Now you have

the load capacity to transport the cement and your friend home. In metric units, the calculation would be:  $635 \text{ kilograms} - (2 \times 99 \text{ kilograms}) - (9 \times 45 \text{ kilograms}) = 635 - 198 - 405 = 32 \text{ kilograms}$ .

The above calculations also assume that the loads are positioned in your vehicle in a manner that does not overload the front or the rear gross axle weight rating specified for your vehicle on the Safety Compliance Certification label.

### Special Loading Instructions for Owners of Pick-up Trucks and Utility-type Vehicles

#### WARNING



Loaded vehicles may handle differently than unloaded vehicles. Take extra precautions, such as slower speeds and increased stopping distance, when driving a heavily loaded vehicle.

#### BED RAMPS (If Equipped)

##### WARNINGS



When sliding the ramp up or down, take care not to get your fingers or hands caught in the mechanism. Failure to follow this instruction could result in personal injury.



Make sure that you correctly install the ramp to the tailgate plate. Failure to follow this instruction could result in personal injury.

# Load Carrying

## WARNINGS



Do not step or sit on the ramp when it is in the stowed position. Failure to follow this instruction could result in personal injury.



Only install the ramp within the prescribed ramp angles. Failure to follow this instruction could result in personal injury.

**Note:** The ramp maximum capacity is 800 lb (363 kg).

**Note:** Verify the ramp is on stable ground before usage.

**Note:** For loading and unloading equipment, your ramp should be set between 10 degrees upward and 26 degrees downward to avoid damage to the ramp claw and tailgate plate.

**Note:** When using your vehicle for off-road operation, remove the bed ramps from the vehicle and store them in a safe location away from your vehicle.

## Using the Bed Ramp

1. Remove the front and rear cables.

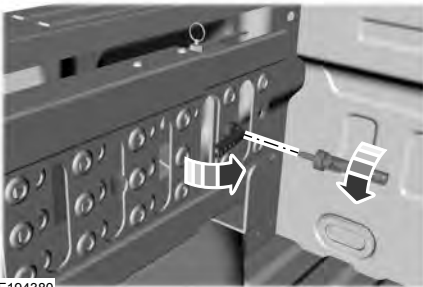

E194380

2. Open the cam lever arms and unscrew the cam bolts.
3. Remove the ramp from the ramp holder.



E211150

4. Rotate the stops at the underside of the ramp to the open position.

**Note:** You can use a smooth surface tool to rotate the stops.

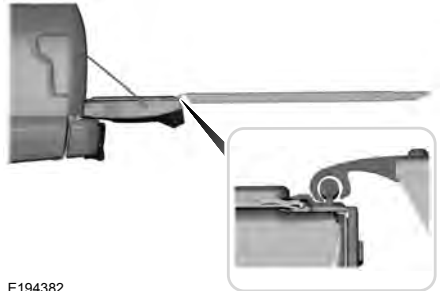

E194382

5. Slide the ramp claw onto the tailgate plate.



## Load Carrying



E194383

6. Pull the location pin outward and extend the ramp until the pin is seated in the usage position, then set the ramp on even ground.

### Stowing the Bed Ramp

1. Pick up the ramp. Pull the location pin outward.
2. Slide the ramp into the storage position until the location pin locks.

**Note:** Make sure the proper pin location has been applied for your bed size.

3. Slide the ramp claw off of the tailgate plate.
4. Rotate the stops at the underside of the ramp to the closed position.

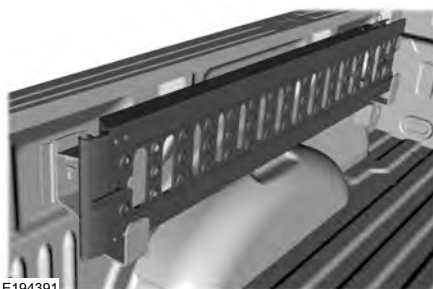

E194391

5. Place the ramp into the ramp holder.
6. Install the cam bolts and close the cam lever arms.
7. Attach the front and rear cables.

**Note:** Make sure you properly secure the locking cable. If the locking cable is unsecured, you may hear a rattling noise.

### Installing the Ramp Holder



E194387

1. Hook the top of the ramp holder over the mounting plate and rotate the ramp holder into position.

## Load Carrying

---

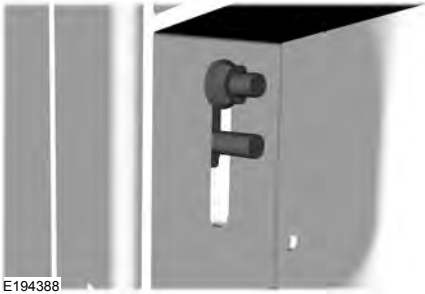

2. Slide the ramp holder studs upwards into the installed position.
3. Tighten the ramp holder nut.

**Note:** *The nut should be on the upper stud.*

# Towing

---

## TOWING A TRAILER

### WARNINGS



Do not exceed the GVWR or the GAWR specified on the certification label.



Towing trailers beyond the maximum recommended gross trailer weight exceeds the limit of your vehicle and could result in engine damage, transmission damage, structural damage, loss of vehicle control, vehicle rollover and personal injury.



Do not exceed the lowest rating capacity for your vehicle or trailer hitch. Overloading your vehicle or trailer hitch can impair your vehicle stability and handling. Failure to follow this instruction could result in the loss of control of your vehicle, personal injury or death.



Do not cut, drill, weld or modify the trailer hitch. Modifying the trailer hitch could reduce the hitch rating.

---

**Note:** *To prevent your trailer from accumulating distance, and the trailer information status appearing when you restart your vehicle after disconnecting your trailer, you must deactivate your trailer. Using the information display, go to the Towing menu and then the Select Trailer option. Select the No active trailer option. See **Information Displays** (page 113).*

Your vehicle may have electrical items, such as fuses or relays, related to towing. See **Fuses** (page 317).

Your vehicle may have ability to modify trailer towing features. See **General Information** (page 113).

Your vehicle's load capacity designation is by weight, not by volume, so you cannot necessarily use all available space when loading a vehicle or trailer.

Towing a trailer places an extra load on your vehicle's engine, transmission, axle, brakes, tires and suspension. Inspect these components periodically during, and after, any towing operation.

# Towing

---

## Load Placement

To help minimize how trailer movement affects your vehicle when driving:

- Load the heaviest items closest to the trailer floor.
- Load the heaviest items centered between the left and right side trailer tires.
- Load the heaviest items above the trailer axles or just slightly forward toward the trailer tongue. Do not allow the final trailer tongue weight to go above or below 10-15% of the loaded trailer weight.
- Select a ball mount with the correct rise or drop. When both the loaded vehicle and trailer are connected, the trailer frame should be level, or slightly angled down toward your vehicle, when viewed from the side.

When driving with a trailer or payload, a slight takeoff vibration or shudder may be present due to the increased payload weight. Additional information regarding proper trailer loading and setting your vehicle up for towing is located in another chapter of this manual. See **Load Limit** (page 264).

You can also find information in the **RV & Trailer Towing Guide** available at your authorized dealer, or online.

<b>RV &amp; Trailer Towing Guide Online</b>	
Website	<a href="http://www.fleet.ford.com/towing-guides/">http://www.fleet.ford.com/towing-guides/</a>

# Towing

## TRAILER REVERSING AIDS

### Trailer Reverse Guidance

#### WARNING



Driving while distracted can result in loss of vehicle control, crash and injury. We strongly recommend that you use extreme caution when using any device that may take your focus off the road. Your primary responsibility is the safe operation of your vehicle. We recommend against the use of any hand-held device while driving and encourage the use of voice-operated systems when possible. Make sure you are aware of all applicable local laws that may affect the use of electronic devices while driving.

**Note:** *You must always be aware of the vehicle and trailer combination and the surrounding environment.*

**Note:** *The system does not detect or prevent the vehicle or trailer from making contact with obstacles in the surrounding environment.*

**Note:** *Keep in mind that the front end of the vehicle swings out when changing the direction of the trailer.*

**Note:** *The system relies on user measurements to determine sticker placement and system limits. It is critical to take the key measurements correctly. Incorrect measurements can result in the improper function of the system up to and including contact between the vehicle and trailer.*

**Note:** *The system limits vehicle speed when backing up. The system is not a replacement for proper use of the throttle and brake pedals.*

**Note:** *Some features associated with this system do not work until you set it up.*

### Principle of Operation

Trailer reverse guidance is a driver assistance feature that helps take the guesswork out of getting your trailer positioned where you want it, quickly and easily, when driving in reverse (R).

Each trailer you use with your vehicle has to be setup once. Sticker placement is extremely important and there are specific placement rules.

### Setting Up Trailer Reverse Guidance

**Note:** *Your vehicle saves the trailer information when you enter it into the system. A maximum of 10 trailers can be added to the system.*

#### Step 1: Position your Vehicle and Trailer

Hitch your trailer to the truck and connect the electrical wiring harness. Check to make sure that the wiring is working. See **Essential Towing Checks** (page 286).

Park your vehicle and hitched trailer on a level surface.



E209759

Make sure that the trailer and truck are in line with each other. You can do this by putting the truck in drive (D) and pulling straight forward.



E209760

# Towing

## Step 2: Follow the Information Display Prompts

1. Use the steering wheel controls to navigate to the towing menu.
2. Select Trailer Setup from the available options.
3. Select Add a Trailer and press OK to confirm.
4. The system asks you to name the trailer. Use the steering wheel controls to choose from the alphanumeric characters. Press the right arrow to advance to the next character. When you finish naming the trailer, press OK to confirm.
5. Select the type of brake system for your trailer. Select DEFAULT if your trailer has electric, surge or no brakes. Press OK to select and advance to the next screen

**Note:** The default option is low. This is recommended for most trailers. If the trailer's brakes require more initial voltage, or if you prefer more aggressive braking, then select the other options as required.

6. The system asks you to select your trailer type. You can use the system with conventional, fifth wheel and goose neck trailers. For fifth wheel and goose neck trailers, set up and sticker placement are not required, however some of the features do not operate automatically with these trailer types. Use the steering wheel controls to select your trailer type.

**Note:** You can still manually control the camera views on the touchscreen to help you reverse goose neck and fifth wheel trailers.

7. If your vehicle includes a blind spot information system, the system prompts you to setup the trailer blind spot feature. See **Blind Spot Information System** (page 252).

8. A message appears in the information display asking if you want to add trailer reverse guidance. Select Yes to continue.
9. Straighten out the trailer, if necessary.
10. The information display directs you to the quick start guide for how to proceed. The steps are also shown here.

## Step 3: Placing the Target

Place the entire sticker in the gray zone on the trailer outlined in the diagram. The sticker is in the back cover pocket of the quick start guide.

**Note:** An assistant can help to carry out the following procedure.

**Note:** Make sure nothing obstructs the rear view cameras view of the sticker. For example, items such as a jack handle or wiring.

**Note:** Position the sticker on a flat, dry and clean horizontal surface. For best results apply the sticker when temperatures are above 32°F (0°C).

**Note:** Do not move stickers after they are placed. Do not re-use any stickers if removed.

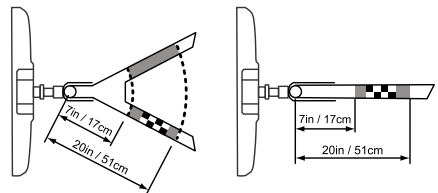

E224482

# Towing

Use the supplied measurement card, a tape measure and pen to carefully mark the area where to attach the sticker. The sticker is supplied in the back cover pocket of your quick start guide. Make sure the entire sticker is within the gray zone between the two arcs or distance markers on the diagram, and is also visible in the rear view camera display. It should be between 7–20 in (17–51 cm) from the trailer ball hitch.

Once you have found the correct location, place the sticker.

## Step 4: Take Measurements

After you place the sticker on the trailer you must take some measurements.

**Note:** You must take accurate measurements for the system to operate properly.

**Note:** Round measurement figures to the nearest half inch.

**Note:** Round upward if the measured length is a quarter inch or greater. Round downward if the measure length is less than a quarter inch. For example 12.25 in (31.11 cm) would be rounded up to 12.50 in (31.75 cm). 12.13 in (30.8 cm) would be rounded down to 12.00 in (30.48 cm).

**Note:** Use consistent metric or imperial units as required by your country or vehicle.

The measurement card requires you to record four key distances (A, B, C, D). Record the trailer name for these measurements.

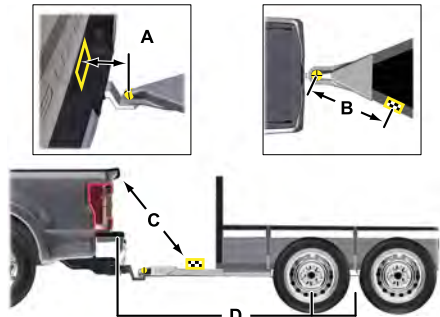

E231167

### Distance A

The horizontal distance from the license plate to the center of the ball hitch on the trailer.

### Distance B

The horizontal distance from the center of the ball hitch to the center of the sticker.

### Distance C

The distance from the rear view camera to the center of the sticker.

### Distance D

The distance from the tailgate to the center of the trailer axle (single axle trailers), or the center of the axles (trailers with dual axles or more).

# Towing

## Step 5: Enter Measurements Using the Information Display

Using the measurements you recorded, enter the required data into the system. Follow the on screen prompts to enter each of the measurements taken in step 4. Use the up and down arrows to increase or decrease the numbers as necessary. Press OK to confirm each measurement. Once you add the last measurement, the information display shows all of the entered measurements. You can choose to confirm or change the measurements.

## Step 6: Confirming the Sticker Location

Check the rear view camera display to see if the system identifies the sticker. The system marks the sticker with a red circle. Confirm that the red circle shows over the sticker image in the rear view camera display.

**Note:** *If the system cannot locate the sticker, try cleaning the camera lens. Make sure the sticker is within the zone as indicated in step 3.*

The information display shows a confirmation message when you successfully confirm the target.

## Calibrating the System

To complete setup, drive your vehicle straight forward between 4–24 mph (6–39 km/h), as directed by the information display.

**Note:** *Keep the steering wheel straight during the calibration process. If the steering wheel is in a turned position, the calibration pauses. The information display prompts you to drive straight forward to complete the calibration.*

The information display shows a message during calibration and after calibration is complete

**Note:** *For best results, do not calibrate the system at night.*

## Using Trailer Reverse Guidance

1. Shift into reverse (R). Press the rear camera button to expand the menu.
2. Press the trailer icon.
3. Select the applicable trailer in the information display.
4. When in trailer reverse guidance mode, you can see the camera view on the side your trailer is moving, or both sides when the trailer is straight behind you. When the views change with the trailer direction, it is called auto mode. For example, if you turn the trailer to the right, you see the right side of your vehicle and trailer. You can switch this view manually at any time by using the arrow keys. To return to auto mode, press the auto button.

**Note:** *Auto mode is the default setting.*

Use the view that helps you the most when reversing your vehicle and trailer.



Normal rear view camera view. Use this feature when you want to see your trailer hitch or what is directly behind your vehicle.



Straight back-up mode. Use this feature when you want to keep your trailer completely in line with your truck. In this mode, a steering wheel graphic shows you which way to turn your steering wheel to keep your trailer straight.

**Note:** *It may be helpful to shift your vehicle into drive (D), pull forward and straighten out the vehicle and trailer before engaging straight back-up mode.*

Left and right arrows let you see other views regardless of your trailer angle. Use them to switch views manually.



# Towing

**Note:** *If you're using a fifth wheel or goose neck trailer, or if you have not set up the trailer reverse guidance system, auto view is not available.*

To change your view, use the arrows. You can see the following views:

- Full driver.
- Partial driver.
- 50/50.
- Partial passenger.
- Full passenger.



Zoom. Use this feature to zoom in the camera view.



Return. This feature takes you back to the 360-degree camera system and out of the trailer reverse guidance feature.



Auto. This feature returns you to auto view.

In addition to multiple view options, your touchscreen adds some features to give you more information. For example, after setting up a conventional trailer, the display shows a small top-view representation of your truck and trailer.

This representation shows two, different-colored lines: A black line shows you where your trailer is in relation to your vehicle. A white line gives you a projection of where your trailer may go based on your current steering wheel position

**Note:** *When you move the steering wheel, the white line indicates where the trailer may go based on your steering wheel input.*

*When you turn your steering wheel to the left, the trailer moves to the right. When you turn your steering wheel to the right, the trailer moves to the left.*

When you turn the steering wheel, a small representation shows you two zones to warn you of a possible jackknife condition. The view shows your truck and trailer position and provides visual feedback to help avoid a jackknife condition entirely.

The yellow zone warns you of a potential jackknife position. When you enter into this zone, it is recommended to put your vehicle back into drive (D) and pull forward. Moving forward helps put the truck and trailer back into an in-line position.

The red zone indicates that you need to put the truck into drive (D) and pull forward immediately.

## Troubleshooting

**Note:** *The system requires a clear view of the sticker placed on the trailer. You must keep the camera lens and sticker clean for the system to operate correctly.*

## Setup

The system is designed to be used with a wide variety of trailers. However, there are some trailers that do not have a proper surface and location to mount the sticker. These trailers are not supported. Attempts to place the sticker on a surface that does not meet the sticker placement requirement listed in Step 3 of the setup instruction, or entering inaccurate measurements to proceed through setup can result in improper system function.

Accurate measurements are critical to correct system function. If you need to check measurements or change them, you can access them through the trailer menus in the information display. Choose the option to change the sticker from the change trailer settings menu. It is not necessary to remove the sticker if you are just reviewing or changing measurements.

# Towing

---

The following menu warnings or difficulties may occur during setup. Tips to resolve them are listed below.

Measurement A has reached maximum or minimum value:

- The system is designed to work with drawbars that have a license plate to hitch ball center measurement of 9–16 in (229–406 mm) when installed. Do not attempt to use drawbars that have a length outside this range as system performance degrades and could cause improper system function.
- Make sure that the measurement being made is the horizontal distance only from license plate and the hitch ball center. A straight line distance that includes any vertical rise or drop increases the measurement and makes it inaccurate. Inaccurate measurements degrade system performance and could cause improper system function. See step 4 of the setup instruction to review the measurement instructions.

Measurement B has reached maximum or minimum value:

- Make sure you follow the sticker placement instruction in step 3 of the setup. Stickers placed outside the allowed zone adversely affect the system performance and could cause improper feature function.
- Make sure that the measurement being made is the horizontal distance only from center of sticker to the hitch ball center. A straight line distance that includes any vertical rise or drop increases the measurement and causes an inaccurate value to be entered into the system. See step 4 of the setup for additional measurement instructions.

Measurement C has reached maximum or minimum value:

- Make sure you follow the sticker placement instructions in step 3 of the setup. Stickers placed outside the allowed zone adversely affect the system performance and could cause improper feature function. If you have met all the criteria for sticker placement and you see this message, the sticker is either too far below or too close to the camera to properly recognize the sticker. In order for the system to correctly operate, the sticker height must be lowered if you receive the minimum warning or the sticker height must be raised if you receive the maximum warning.
  - Only one sticker can be placed on the trailer for correct system function. The previous sticker must be removed or covered so only one sticker is visible to the camera.
  - Measurement B and C must be measured again if a new sticker is placed on the trailer.

Measurement D has reached maximum or minimum value:

- Make sure that the measurement being made is the horizontal distance only from tailgate to the center of the single axle or the center of all the axles on the trailer. See step 4 of the setup for additional measurement instructions. The system does not support trailer lengths outside the range allowed by the information display.

# Towing

---

System is circling something beside the sticker or system cannot find the sticker:

- Make sure the rear camera is clean and the sticker is clearly visible in the camera image. Clean the camera and sticker if necessary.
- The camera system uses the entered measurements to help locate the sticker. Inaccurate sticker measurements degrade the system's ability to locate the sticker. Verify the measurements entered into the system are accurate.
- Remove the incorrectly circled label or decal if possible.
- If you cannot resolve the issue, a new sticker location should be tried. The new sticker location must meet the requirements noted in step 3 of the setup instructions. Only one sticker can be placed on the trailer for correct system function. The previous sticker must be removed or covered so only one sticker is visible to the camera.

## Calibration

The system monitors various vehicle parameters to ensure your vehicle is being driven straight and the trailer straight behind your vehicle. Any steering input or trailer movement pauses the calibration.

For best results:

- Use a long, straight and smooth road when attempting to calibrate.
- Drive straight forward.
- Drive between 4–24 mph (6–39 km/h).

## System Operation

The following warnings or difficulties may occur during feature operation. Tips to resolve them are listed below.

The system is not available:

- The system relies on many sub-systems in your vehicle to correctly operate. If those sub-systems are not correctly operating, the system may not be available.
  - Low battery voltage is one condition which prevents the system from operating. Please make sure the battery is correctly charged if the system is not available.
  - You may need to drive your vehicle straight forward above 25 mph (40 km/h) before the system is available again.
- If the message still displays, take your vehicle to an authorized dealer for service.

Sticker lost:

- Check for the following if you receive the lost sticker message when using the system.
  - Stop your vehicle as soon as the message displays.
  - Make sure the sticker is visible in the rear view camera image.
  - Clean the sticker and camera to make sure they are unobstructed.
  - Remove any items that may be blocking the view of the sticker. Depending on your trailer configuration and any equipment mounted to your trailer, it is possible for the sticker to be blocked from the view of the camera as it rotates on the hitch ball, but not be blocked during setup. Remove the obstruction if possible. It may be necessary to

# Towing

remove the sticker from its current location if the obstruction cannot be cleared. Place a new sticker that is visible to the camera in all positions of the trailer behind your vehicle.

- You can change your sticker location by going into the trailer menu, selecting trailer options, selecting change trailer settings and then selecting the change sticker option. The previous sticker must be removed. **ONLY ONE STICKER SHOULD BE PLACED ON THE TRAILER FOR CORRECT SYSTEM FUNCTION.**
- The camera system uses the entered measurements to help locate the sticker. Inaccurate measurements reduce the system's ability to locate the sticker. Check the measurements entered into the system are correct. Refer to the step 4 of trailer reverse guidance setup for instructions on measurements.
- You can change your measurement by going into the trailer menu, selecting trailer options, selecting change trailer setting and then selecting the change sticker option. Disregard the prompt to remove this sticker and continue to the next step if you only plan to update the measurements for the current sticker location.

System does not backup straight:

- Factors such as the drawbar connection to the hitch receiver, road camber, road grade and compliance in the trailer suspension can influence how straight the system is able to reverse your trailer when the wheel is not turned. You can compensate for the trailer drifting to the right or left by

slowly turning the wheel until the trailer is following your desired path and then holding the wheel in that position. If you would like to recalibrate the system for straight backing, you can do so with the following procedure.

- Go into the trailer menu, select trailer options, select change trailer setting and then select the change sticker option. Your saved measurements show. Do not change them, but continue to confirm measurements. Once you confirm the measurements, the system then prompts you to perform the calibration procedure.

**Note:** *The system is designed to be used with the same trailer connection every time the trailer is chosen from the selection menu. Using a different drawbar or a different pin hole, on drawbars with more than one pin hole, when connecting the drawbar to your vehicle affects the trailer measurements. Take the measurements again and update if required.*

## TRAILER SWAY CONTROL (If

Equipped)

### WARNING



Turning off trailer sway control increases the risk of loss of vehicle control, serious injury or death. Ford does not recommend disabling this feature except in situations where speed reduction may be detrimental (such as hill climbing), the driver has significant trailer towing experience, and can control trailer sway and maintain safe operation.

**Note:** *This feature does not prevent trailer sway, but reduces it once it begins.*

**Note:** *This feature cannot stop all trailers from swaying.*

# Towing

**Note:** In some cases, if vehicle speed is too high, the system may activate multiple times, gradually reducing vehicle speed.

This feature applies your vehicle brakes at individual wheels and, if necessary, reduces engine power. If the trailer begins to sway, the stability control light flashes and the message **TRAILER SWAY REDUCE SPEED** appears in the information display. The first thing to do is slow your vehicle down, then pull safely to the side of the road and check for proper tongue load and trailer load distribution. See **Load Carrying** (page 264).

## RECOMMENDED TOWING WEIGHTS

### WARNING



You must use the heavy-duty drawbar pin supplied with your vehicle when using the heavy-duty hitch. Failure to follow this instruction could result in the loss of control of your vehicle, personal injury or death.

**Note:** Vehicles with a heavy-duty hitch must use the drawbar pin stamped 21,000 LBS. You can obtain a replacement drawbar pin at your authorized dealer.

**Note:** Make sure to take into consideration trailer frontal area. Do not exceed 60 ft<sup>2</sup> (5.6 m<sup>2</sup>) trailer frontal area for conventional trailers. Do not exceed 75 ft<sup>2</sup> (6.9 m<sup>2</sup>) trailer frontal area for fifth wheel and gooseneck trailers.

**Note:** Exceeding this limitation may significantly reduce the performance of your towing vehicle. Selecting a trailer with a low aerodynamic drag and rounded front design helps optimize performance and fuel economy.

**Note:** For high altitude operation, reduce the gross combined weight by 2% per 1,000 ft (300 m) starting at the 1,000 ft (300 m) elevation point.

**Note:** Certain states require electric trailer brakes for trailers over a specified weight. Be sure to check state regulations for this specified weight. The maximum trailer weights listed may be limited to this specified weight, as your vehicle's electrical system may not include the wiring connector needed to use electric trailer brakes.

Your vehicle may tow a trailer provided the maximum trailer weight is less than or equal to the maximum trailer weight calculated using the formula following the chart.

## Towing

<b>Pickup and box delete</b>			
<b>Vehicle</b>	<b>Engine</b>	<b>Rear axle ratio</b>	<b>Maximum GCWR</b>
F-250	6.2L gas	3.73	19,500 lb (8,845 kg)
		4.30	22,000 lb (9,979 kg)
	6.7L diesel	3.31, 3.55	23,500 lb (10,660 kg)
	6.7L diesel <sup>1</sup>	3.31, 3.55	25,700 lb (11,657 kg)
F-350 single rear wheel	6.2L gas	3.73	19,500 lb (8,845 kg)
		4.30	23,000 lb (10,433 kg)
	6.7L diesel	3.31, 3.55	28,700 lb (13,018 kg)
F-350 dual rear wheel	6.2L gas	3.73	20,000 lb (9,072 kg)
		4.30	23,500 lb (10,660 kg)
	6.7L diesel	3.55	36,000 lb (16,329 kg)
		4.10	40,000 lb (18,144 kg)
F-450	6.7L diesel	4.30	42,800 lb (19,414 kg)

<sup>1</sup> Trailer Tow Package.

## Towing

<b>Chassis cab</b>			
<b>Vehicle</b>	<b>Engine</b>	<b>Rear axle ratio</b>	<b>Maximum GCWR</b>
F-350 single rear wheel	6.2L gas	3.73	19,500 lb (8,845 kg)
		4.30	23,000 lb (10,433 kg)
	6.7L diesel	3.73	26,500 lb (12,020 kg)
F-350 dual rear wheel	6.2L gas	3.73	20,000 lb (9,072 kg)
		4.30	23,500 lb (10,660 kg)
	6.7L diesel	3.73	31,000 lb (14,062 kg)
		4.10	32,000 lb (14,515 kg)
F-450 dual rear wheel	6.8L gas	4.88	28,000 lb (12,701 kg)
	6.7L diesel	4.10	32,000 lb (14,515 kg)
		4.30	34,500 lb (15,649 kg) <sup>1</sup>
F-550 dual rear wheel (17500/ 18000 lb GVWR)	6.8L gas	4.88	28,000 lb (12,701 kg)
	6.7L diesel	4.10	32,000 lb (14,515 kg)
		4.30	35,000 lb (15,876 kg)

# Towing

Chassis cab			
Vehicle	Engine	Rear axle ratio	Maximum GCWR
F-550 dual rear wheel (19000/19500 lb GVWR)	6.8L gas	4.88	28,000 lb (12,701 kg)
	6.7L diesel	4.88	32,000 lb (14,515 kg)
		4.88	40,000 lb (18,144 kg) <sup>1</sup>

<sup>1</sup> Requires optional GCWR Package.

## Calculating the Maximum Loaded Trailer Weight for Your Vehicle

1. Start with the gross combined weight rating for your vehicle model and axle ratio. See the previous chart.
2. Subtract all of the following that apply to your vehicle:
  - Vehicle curb weight.
  - Hitch hardware weight, such as a draw bar, ball, locks or weight distributing hardware.
  - Driver weight.
  - Passenger(s) weight.

- Payload, cargo and luggage weight.
- Aftermarket equipment weight.

This equals the maximum loaded trailer weight for this combination.

**Note:** *The trailer tongue load is considered part of the payload for your vehicle. Reduce the total payload by the final trailer tongue weight.*

**Note:** *Consult an authorized dealer to determine the maximum trailer weight allowed for your vehicle if you are not sure.*

For additional information on trailer weights, reference the **RV & Trailer Towing Guide** available at your authorized dealer, or online.

RV & Trailer Towing Guide Online	
Website	<a href="http://www.fleet.ford.com/towing-guides/">http://www.fleet.ford.com/towing-guides/</a>



# Towing

## ESSENTIAL TOWING CHECKS

### WARNING



Do not exceed the maximum vertical load on the tow ball. Failure to follow this instruction could result in the loss of control of your vehicle, personal injury or death.

Follow these guidelines for safe towing:

- Do not tow a trailer until you drive your vehicle at least 1,000 mi (1,600 km).
- Consult your local motor vehicle laws for towing a trailer.
- See the instructions included with towing accessories for the proper installation and adjustment specifications.
- Service your vehicle more frequently if you tow a trailer. See your scheduled maintenance information. See **Scheduled Maintenance** (page 581).
- If you use a rental trailer, follow the instructions the rental agency gives you.

See **Load Limits** in the Load Carrying chapter for load specification terms found on the tire label and Safety Compliance label and instructions on calculating your vehicle's load.

Vehicles with a diesel engine have an engine braking feature. See **General Information** (page 225).

Remember to account for the trailer tongue weight as part of your vehicle load when calculating the total vehicle weight.

Some vehicles will have the ability to modify trailer towing features. See **General Information** (page 113).

## Trailer Towing Connector



E163167

When attaching the trailer wiring connector to your vehicle, only use a proper fitting connector that works with the vehicle and trailer functions. Some seven-position connectors may have the SAE J2863 logo, which confirms that it is the proper wiring connector and works correctly with your vehicle.

Color	Function
Yellow	Left turn signal and stop lamp
White	Ground (-)
Blue	Electric brakes
Green	Right turn signal and stop lamp
Orange	Battery (+)
Brown	Running lights
Grey	Reverse lights

# Towing

**Note:** If your vehicle is equipped with a factory brake controller, the Battery (+) Orange wire is powered when you start the engine and you apply the brakes at least once when a trailer with brake lamps is connected. If your vehicle is not equipped with a factory brake controller, relays control the system and it becomes active when you power on your vehicle.

## Dynamic Hitching Using the Rear View Camera System

**Note:** Active guidelines and fixed guidelines are only available when the transmission is in reverse (R).

Use the centerline (B) guideline to assist you in setting your steering wheel properly to help align the trailer hitch and tongue.

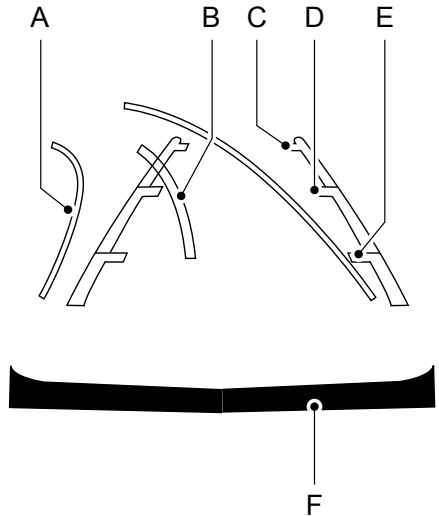

E142436

- A Active guidelines.
- B Centerline.
- C Fixed guideline: Green zone.
- D Fixed guideline: Yellow zone.
- E Fixed guideline: Red zone.
- F Rear bumper.

Fixed guidelines are always shown in the display, but the active guidelines only display when the steering wheel is turned. To use active guidelines, turn the steering wheel to point the guidelines toward an intended path. If the steering wheel position is changed while reversing, your vehicle might deviate from the original intended path.

# Towing

The active guidelines fade in and out depending on the steering wheel position. The active guidelines are not shown when the steering wheel position is straight.

Always use caution while reversing. Objects in the red zone are closest to your vehicle and objects in the green zone are farther away. Objects are getting closer to your vehicle as they move from the green zone to the yellow or red zones. Use the side view mirrors and rear view mirror to get better coverage on both sides and rear of your vehicle.

Refer to the Rear View Camera section for additional information. See **Rear View Camera** (page 236).

## Hitches

**Note:** On pick-up trucks, the trailer hitch provided on this vehicle enhances crash protection for the fuel system. Do not remove!

**Note:** Do not cut, drill, weld or modify trailer hitches. Modifying trailer hitches can reduce hitch rating.

Do not use a hitch that either clamps onto the bumper or attaches to the axle. You must distribute the load in your trailer so that 10-15% for conventional towing or 15-25% for fifth wheel towing of the total weight of the trailer is on the tongue.

## Hitch Components (If Equipped)

The following components are required. Some are provided in certain vehicles.

- A trailer hitch with a 3 inch receiver and 5/8 inch hitch pin rated to tow up to 21,000 lb (9,525 kg).
- A hitch pin sleeve stored in the glove box to be used when mounting the 3 inch drawbar.
- A cotter pin to help keep the hitch pin in place.

## Installing a 3 Inch Drawbar with 3/4 Inch Pin Hole

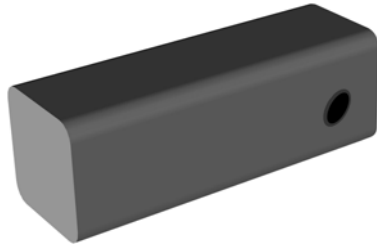
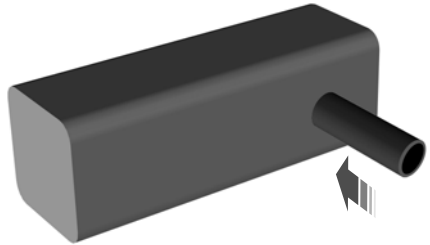

E247903

The pin sleeve should be inserted in the 3/4 inch pin hole of the 3 inch drawbar.



E247902

Remove reducers before inserting the 3 inch drawbar. Insert the drawbar into hitch receiver.

# Towing

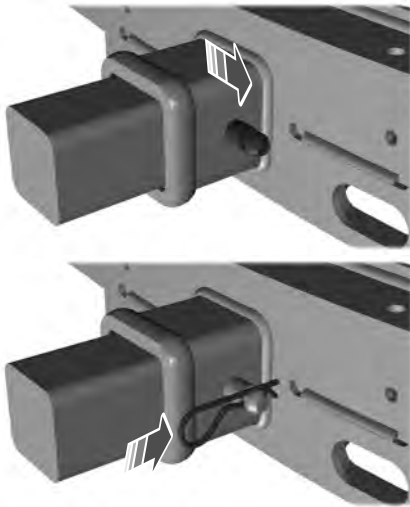

E247909

Put the 5/8 inch hitch pin through pin hole. Place the cotter pin around the neck of hitch pin.

## Weight-distributing Hitches

### WARNING



Do not adjust the spring bars so that your vehicle's rear bumper is higher than before attaching the trailer.

Doing so will defeat the function of the weight-distributing hitch, which may cause unpredictable handling, and could result in serious personal injury.

When hooking-up a trailer using a weight-distributing hitch, always use the following procedure:

1. Park the loaded vehicle, without the trailer, on a level surface.
2. Measure the height to the top of your vehicle's front wheel opening on the fender. This is H1.

3. Attach the loaded trailer to your vehicle without the weight-distributing bars connected.
4. Measure the height to the top of your vehicle's front wheel opening on the fender a second time. This is H2.
5. Install and adjust the tension in the weight-distributing bars so that the height of your vehicle's front wheel opening on the fender is approximately halfway between H1 and H2.
6. Check that the trailer is level or slightly nose down toward your vehicle. If not, adjust the ball height accordingly and repeat Steps 2-6.

Once the trailer is level or slightly nose down toward the vehicle:

- Lock the bar tension adjuster in place.
- Check that the trailer tongue securely attaches and locks onto the hitch.
- Install safety chains, lighting, and trailer brake controls as required by law or the trailer manufacturer.

## Fifth-wheel Trailer Hitch (If Equipped)

**Note:** *The mounting pads in the bed are specifically designed for certain fifth-wheel trailer hitches and gooseneck ball hitches. Do not use these mounting pads for other purposes.*

**Note:** *Contact an authorized dealer to purchase gooseneck and fifth-wheel hitches that are compatible with your vehicle.*

Your vehicle may be equipped with a fifth-wheel prep package. This package enables your vehicle to accept certain fifth-wheel trailer hitches and gooseneck ball hitches. The fifth-wheel trailer hitch attaches to the four mounting pads in the pick-up bed. An optional 7-pin trailer wiring connector may be in the bed as well. The gooseneck ball hitch is a separate mounting pad from the fifth-wheel hitch, located in the center of the bed.

# Towing

Shorter pick-up boxes, such as the 6½-foot box on the F-250 and F-350, provide less clearance between the cab and the fifth-wheel and gooseneck trailer compared to longer box pick-ups, such as an 8-foot box on the F-250 or F-350. When selecting a trailer and tow vehicle, it is critical to check that this combination provides clearance between the front of the trailer and tow vehicle for turns up to 90 degrees. Failure to follow this recommendation could result in the trailer contacting the cab of the tow vehicle during tight turns that are typical during low-speed parking and turning maneuvers. This contact could result in damage to the trailer and tow vehicle.

## Safety Chains

**Note:** Do not attach safety chains to the bumper. Always connect the safety chains to the frame or hook retainers of your trailer hitch.

Install trailer safety chains to the trailer hitch as recommended by the manufacturer. Cross the chains under the trailer tongue and allow enough slack for turning tight corners. Do not allow the chains to drag on the ground.

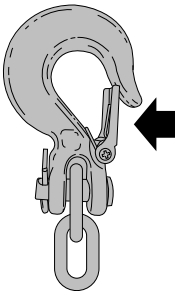

E265060

If the trailer safety chain hook has a latch, make sure the latch is fully closed.

**Note:** If you install the hook with the latch facing toward the rear of your vehicle, you may not be able to fully close the safety chain hook latch. If this occurs, install the hook with the latch facing toward the front of your vehicle.

## Trailer Brakes

### WARNING



Do not connect a trailer's hydraulic brake system directly to your vehicle's brake system. Your vehicle may not have enough braking power and your chances of having a collision greatly increase.

Electric brakes and manual, automatic or surge-type trailer brakes are safe if you install them properly and adjust them to the manufacturer's specifications. The trailer brakes must meet local and federal regulations.

**The rating for the tow vehicle's braking system operation is at the gross vehicle weight rating, not the gross combined weight rating.**

**Separate functioning brake systems are required for safe control of towed vehicles and trailers weighing more than 1500 lb (680 kg) when loaded.**

## Integrated Trailer Brake Controller

(If Equipped)

### WARNINGS



The anti-lock brake system does not control the trailer brakes.



Use the integrated trailer brake controller to properly adjust the trailer brakes and check all connections before towing a trailer. Failure to follow this instruction could result in the loss of control of your vehicle, personal injury or death.

# Towing

**Note:** The integrated Ford brake controller is compatible with trailers equipped with electric-actuated drum brakes and electric-over hydraulic brake systems.

**Note:** The integrated Ford brake controller does not control hydraulic surge-style brakes.

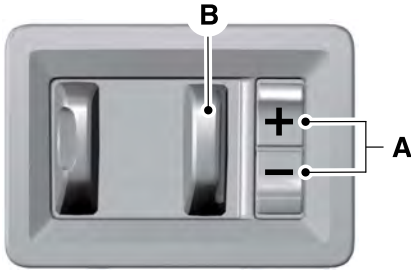

E183395

When used properly, the trailer brake controller assists in smooth and effective trailer braking by powering the trailer's electric or electric-over-hydraulic brakes with a proportional output based on the towing vehicle's brake pressure.

You can adjust the amount of initial trailer brake output by selecting one of three settings through the message center.

Ford has tested the trailer brake controller to be compatible with several major brands of electric-over-hydraulic trailer brakes. Contact an authorized dealer for information on which brands you can use.

The controller user interface consists of the following:

**A:** + and - (Gain adjustment buttons): Pressing these buttons adjusts the controller's power output to the trailer brakes in 0.5 increments. You can increase the gain setting to 10.0 (maximum trailer braking) or decrease it to 0 (no trailer braking). Pressing and holding a button raises or lowers the setting continuously. The gain setting displays in the message center as follows: **TBC GAIN = XX.X**.

**B:** Manual control lever: Slide the control lever to the left to switch on the trailer's electric brakes independent of the tow vehicle's. See the following **Procedure for adjusting gain** section for instructions on proper use of this feature. If you use the manual control while the brake is also applied, the greater of the two inputs determines the power sent to the trailer brakes.

- **Stop lamps:** Using the manual control lever lights both the trailer brake lamps and your vehicle brake lamps.

Trailer brake control messages appear in the information display as follows:

- **TBC GAIN = XX.X NO TRAILER:** Shows the current gain setting.
- **TBC GAIN = XX.X OUTPUT=/////** //: Displays when braking. The bars indicate the amount of power going to the trailer brakes.
- **TRAILER CONNECTED:** Displays when the system senses a correct trailer wiring connection.
- **TRAILER DISCONNECTED:** Displays when the system senses a trailer disconnection.

## Procedure for Setting Trailer Brake Controller Effort

Choose either the electric option for trailers with electromagnetic drum brakes, or the electric over hydraulic option for trailers with these brake systems.

# Towing

## Trailer Brake Effort Setting

The trailer brake controller allows the user to customize how aggressively the trailer brakes engage. The default value is the low setting and is the recommended setting for most trailers. If your trailer's brakes require more initial voltage, or if you prefer more aggressive trailer braking, then select either the medium or the high setting.

## Procedure for Setting Trailer Brake Controller Mode

Choose the low, medium or high setting for the required initial trailer brake output.

## Procedure for Adjusting Gain

**Note:** *Only perform this procedure in a traffic-free environment at speeds of approximately 20–25 mph (30–40 km/h).*

The gain setting adjusts the trailer brake controller for the specific towing condition. You should change the setting as towing conditions change. Changes to towing conditions include trailer load, vehicle load, road conditions and weather.

The gain should be set to provide the maximum trailer braking assistance while making sure the trailer wheels do not lock when using the brakes. Locked trailer wheels may lead to trailer instability.

1. Make sure the trailer brakes are in good working condition, functioning normally and properly adjusted. See your trailer dealer if necessary.
2. Hook up the trailer and make the electrical connections according to the trailer manufacturer's instructions.
3. When you plug in a trailer with electric or electric-over-hydraulic brakes, a confirmation message appears in the information display.

4. Use the gain adjustment (+ and -) buttons to increase or decrease the gain setting to the desired starting point. A gain setting of 6.0 is a good starting point for heavier loads.
5. In a traffic-free environment, tow the trailer on a dry, level surface at a speed of 20–25 mph (30–40 km/h) and squeeze the manual control lever completely.
6. If the trailer wheels lock up, indicated by squealing tires, reduce the gain setting. If the trailer wheels turn freely, increase the gain setting. Repeat Steps 5 and 6 until the gain setting is at a point just below trailer wheel lock-up. If towing a heavier trailer, trailer wheel lock-up may not be attainable even with the maximum gain setting of 10.

## Information Display Warning Messages

**Note:** *An authorized dealer can diagnose the trailer brake controller to determine exactly which trailer fault has occurred. However, your Ford warranty does not cover this diagnosis if the fault is with the trailer.*

### TRAILER BRAKE MODULE FAULT

Displays in response to faults sensed by the trailer brake controller, accompanied by a single tone. If this message appears, contact an authorized dealer as soon as possible for diagnosis and repair. The controller may still function, but with degraded performance.

### WIRING FAULT ON TRAILER

Displays when there is a short circuit on the electric brake output wire.

If this message displays, with no trailer connected, the problem is with your vehicle wiring or trailer brake controller. Contact an authorized dealer.

# Towing

If the message only displays with a trailer connected, the problem is with the trailer wiring. Consult your trailer dealer for assistance. This can be a short to ground (such as a chaffed wire), short to voltage (such as a pulled pin on trailer emergency breakaway battery) or the trailer brakes may be drawing too much current.

## Points to Remember

**Note:** *Do not attempt removal of the trailer brake controller without consulting the Workshop Manual. Damage to the unit may result.*

- Adjust gain setting before using the trailer brake controller.
  - Adjust gain setting, using the procedure above, whenever road, weather, trailer or vehicle loading conditions change from when the gain was initially set.
  - Only use the manual control lever for proper adjustment of the gain during trailer setup. Misuse, such as application during trailer sway, could cause instability of trailer or tow vehicle.
  - Avoid towing in adverse weather conditions. The trailer brake controller does not provide anti-lock control of the trailer wheels. Trailer wheels can lock up on slippery surfaces, resulting in reduced stability of trailer and tow vehicle.
  - The trailer brake controller is equipped with a feature that reduces output at vehicle speeds below 11 mph (18 km/h) so trailer and vehicle braking is not jerky or harsh. This feature is only active when applying the brakes using your vehicle's brake pedal, not the controller.
- The controller interacts with the brake control system and powertrain control system of your vehicle to provide the best performance on different road conditions.
  - Your vehicle's brake system and the trailer brake system work independently of each other. Changing the gain setting on the controller does not affect the operation of your vehicle's brakes.
  - When you switch the engine off, the controller output is disabled and the display and module shut down.

## Trailer Lamps

### WARNING



Never connect any trailer lamp wiring to the vehicle's tail lamp wiring; this may damage the electrical system resulting in fire. Contact your authorized dealer as soon as possible for assistance in proper trailer tow wiring installation. Additional electrical equipment may be required.

Trailer lamps are required on most towed vehicles. Make sure all running lights, brake lights, turn signals and hazard lights are working.

## Before Towing a Trailer

Practice turning, stopping and backing up to get the feel of your vehicle-trailer combination before starting on a trip. When turning, make wider turns so the trailer wheels clear curbs and other obstacles.



# Towing

## When Towing a Trailer

- Check your hitch, electrical connections and trailer wheel lug nuts thoroughly after you have traveled 50 mi (80 km).
- Do not drive faster than 70 mph (113 km/h) during the first 500 mi (800 km).
- Do not make full-throttle starts.
- When stopped in congested or heavy traffic during hot weather, place the gearshift in park (P) to aid engine and transmission cooling and to help A/C performance.
- Turn off the speed control with heavy loads or in hilly terrain. The speed control may turn off automatically when you are towing on long, steep grades.
- Shift to a lower gear when driving down a long or steep hill. Do not apply the brakes continuously, as they may overheat and become less effective.
- If your transmission is equipped with a Grade Assist or Tow/Haul feature, use this feature when towing. This provides engine braking and helps eliminate excessive transmission shifting for optimum fuel economy and transmission cooling.
- If your vehicle is equipped with Adaptive Steering and you have enabled Tow/Haul, the Adaptive Steering system adjusts the steering response to match your vehicle's load. The system reduces vehicle sensitivity to steering inputs at higher vehicle speeds while it maintains the ease of parking and maneuverability at low speeds.

- If your vehicle is equipped with AdvanceTrac with RSC, this system may turn on during typical cornering maneuvers with a heavily loaded trailer. This is normal. Turning the corner at a slower speed while towing may reduce this tendency.
- If you are towing a trailer frequently in hot weather, hilly conditions, at the gross combined weight rating (or any combination of these factors), consider refilling your rear axle with synthetic gear lubricant (if the axle is not already filled with it).
- Allow more distance for stopping with a trailer attached. Anticipate stops and brake gradually.
- Avoid parking on a grade. However, if you must park on a grade:
  1. Turn the steering wheel to point your vehicle tires away from traffic flow.
  2. Set your vehicle parking brake.
  3. Place the transmission in park (P).
  4. Place wheel chocks in front and back of the trailer wheels. (Chocks not included with vehicle.)

Your vehicle may be equipped with a temporary or conventional spare tire. A "temporary" spare tire is different in size (diameter or width), tread-type (All-Season or All Terrain) or is from a different manufacturer than the road tires on your vehicle. Consult information on the tire label or Safety Compliance label for limitations when using.

## Launching or Retrieving a Boat or Personal Watercraft (PWC)

**Note:** *Disconnect the wiring to the trailer before backing the trailer into the water.*

**Note:** *Reconnect the wiring to the trailer after you remove the trailer from the water.*

# Towing

When backing down a ramp during boat launching or retrieval:

- Do not allow the static water level to rise above the bottom edge of the rear bumper.
- Do not allow waves to break higher than 6 in (15 cm) above the bottom edge of the rear bumper.

Exceeding these limits may allow water to enter vehicle components:

- Causing internal damage to the components.
- Affecting driveability, emissions, and reliability.

Replace the rear axle lubricant anytime the rear axle has been submerged in water. Water may have contaminated the rear axle lubricant, which is not normally checked or changed unless a leak is suspected or other axle repair is required.

## TOWING THE VEHICLE ON FOUR WHEELS

### WARNING



If your vehicle has a steering wheel lock make sure the ignition is in the accessory or on position when being towed.

## Emergency Towing

If your vehicle becomes inoperable (without access to wheel dollies, car-hauling trailer, or flatbed transport vehicle), it can be flat-towed (all wheels on the ground, regardless of the powertrain and transmission configuration) under the following conditions:

- Your vehicle is facing forward for towing in a forward direction.
- Place the transmission in neutral (N). If you cannot move the transmission into neutral (N), you may need to override it. See **Transmission** (page 208).
- Maximum speed is 35 mph (56 km/h).
- Maximum distance is 50 mi (80 km).

### WARNING



If your vehicle has a steering wheel lock make sure the ignition is in the accessory or on position when being towed.

## Recreational Towing

**Note:** Put your climate control system in recirculated air mode to prevent exhaust fumes from entering your vehicle. See **Climate Control** (page 146).

Follow these guidelines if you have a need for recreational towing, such as towing your vehicle behind a motorhome. We have designed these guidelines to prevent damage to your transmission.

### Two-wheel Drive Vehicles

Do not tow your vehicle with any wheels on the ground, as vehicle or transmission damage may occur. It is recommended to tow your vehicle with all four (4) wheels off the ground, such as when using a car-hauling trailer. Otherwise, you cannot tow your vehicle.

# Towing

## Four-wheel Drive Vehicles Equipped with a Manual-shift Transfer Case

1. Put the transmission in neutral (N).
2. Put the transfer case in neutral (N).
3. Put the hub locks in the **FREE** position. Always make sure that both hub locks are set to the same position.

## Four-wheel Drive Vehicles Equipped with an Electronic-shift Transfer Case

Only tow a four-wheel drive vehicle that has an electronic-shift transfer case with all wheels on the ground. To do this, place the transfer case in its neutral position and engage the four-wheel-down towing feature.

Perform the steps in the following section after positioning your vehicle behind the tow vehicle and properly securing them together.

**Note:** Make sure you properly secure your vehicle to the tow vehicle.

### Four-wheel-down Towing

1. Put the ignition in the on position, but do not start the engine. If your vehicle has an ignition key, turn the key to on. If your vehicle has intelligent access, press the engine **START/STOP** button once without pressing the brake pedal.
2. Press and hold the brake pedal.
3. Rotate the four-wheel drive switch to **2H**.
4. Shift the transmission to neutral (N).
5. Rotate the four-wheel drive switch from **2H** to **4L** and back to **2H** five times within seven seconds.

**Note:** If completed successfully, the information display shows a message indicating that your vehicle is safe to tow with all wheels on the ground.

**Note:** If you do not see the message in the display, you must perform the procedure again from the beginning.

**Note:** You may hear an audible noise as the transfer case shifts into its neutral position. This is normal.

6. Leave the transmission in neutral (N) and turn the ignition as far as it will go toward the off position (it will not turn fully off when the transmission is in neutral). If your vehicle has an ignition key, you must leave the key in the ignition while towing. To lock and unlock your vehicle, use the keyless entry keypad or extra set of keys. If your vehicle has intelligent access, press the engine **START/STOP** button once without pressing the brake pedal. You do not need to leave your keys in the vehicle. You can lock and unlock your vehicle as you normally do.
7. Release the brake pedal.

## WARNINGS



Do not disconnect the battery during recreational towing. It prevents the transfer case from shifting properly and may cause the vehicle to roll, even if the transmission is in park (P).



Shifting the transfer case to its neutral position for recreational towing may cause the vehicle to roll, even if the transmission is in park (P). It may injure the driver and others. Make sure you press the foot brake and the vehicle is in a secure, safe position when you shift to neutral (N).

**Note:** Failing to put the transfer case in its neutral position while towing with all four wheels on the ground will damage vehicle components.

# Towing

---

**Note:** You can check four-wheel-down towing status at any time by opening the driver's door or turning the ignition to the accessory or on position and verifying a message displays in the cluster.

To exit four-wheel-down towing and return the transfer case to its **2H** position:

1. With your vehicle still properly secured to the tow vehicle, put the ignition in the on position, but do not start the engine. If your vehicle has an ignition key, switch the key to on. If your vehicle has intelligent access, press the engine **START/STOP** button once without pressing the brake pedal.
2. Press and hold the brake pedal.
3. Shift the transmission out of neutral (N) and into any other gear.
4. Release the brake pedal.

**Note:** If completed successfully, the **2H** indicator light illuminates and a confirmation message displays in the instrument cluster.

**Note:** If the indicator light and message do not display, you must perform the procedure again from the beginning.

**Note:** You may hear an audible noise as the transfer case shifts out of its neutral position. This is normal.

**Note:** If a message displays in the instrument cluster stating there is a shift delay, transfer case gear tooth blockage may be present. See **Resolving the Shift Delay Issue** after this section.

5. Apply the parking brake and disconnect the vehicle from the tow vehicle.
6. Release the parking brake, start the engine and shift the transmission to drive (D) to make sure the transfer case is out of neutral (N).

7. If the transfer case does not successfully shift out of neutral (N), set the parking brake until you can have your vehicle serviced.

## **Resolving the Shift Delay Issue**

If the instrument cluster displays a shift delay message, See **Information Messages** (page 129). You need to perform the following steps:

1. Press and hold the brake pedal.
2. Put the transmission into neutral (N), and then start the engine.
3. With the engine running, shift the transmission to drive (D) and let the vehicle roll forward, up to 3 ft (1 m). You may hear an audible noise as the transfer case shifts out of its neutral position. This is normal.
4. When the issue is resolved, the instrument cluster displays a message stating neutral tow is disabled.

# Driving Hints

---

## BREAKING-IN

You need to break in new tires for approximately 300 mi (480 km). During this time, your vehicle may exhibit some unusual driving characteristics.

Avoid driving too fast during the first 1,000 mi (1,600 km). Vary your speed frequently and change up through the gears early. Do not labor the engine.

Drive your new vehicle at least 1,000 mi (1,600 km) before towing a trailer. Make sure you use the specified engine oil. See **Capacities and Specifications** (page 427).

Do not add friction modifier compounds or special break-in oils during the first few thousand miles (kilometers) of operation. These additives may prevent piston ring seating.

## ECONOMICAL DRIVING

Your fuel economy is affected by several things, such as how you drive, the conditions you drive under, and how you maintain your vehicle.

You may improve your fuel economy by keeping these things in mind:

- Accelerate and slow down in a smooth, moderate fashion.
- Drive at steady speeds without stopping.
- Anticipate stops; slowing down may eliminate the need to stop.
- Combine errands and minimize stop-and-go driving.
- Close the windows for high-speed driving.
- Drive at reasonable speeds (traveling at 55 mph [88 km/h] uses 15% less fuel than traveling at 65 mph [105 km/h]).

- Keep the tires properly inflated and use only the recommended size.
- Use the recommended engine oil.
- Perform all regularly scheduled maintenance.

Avoid these actions; they reduce your fuel economy:

- Sudden accelerations or hard accelerations.
- Revving the engine before turning it off.
- Idle for periods longer than one minute.
- Warm up your vehicle on cold mornings.
- Use the air conditioner or front defroster.
- Use the speed control in hilly terrain.
- Rest your foot on the brake pedal while driving.
- Drive a heavily loaded vehicle or tow a trailer.
- Carry unnecessary weight (approximately 1 mpg [0.4 km/L] is lost for every 400 lb [180 kilogram] of weight carried).
- Driving with the wheels out of alignment.

Conditions

- Heavily loading a vehicle or towing a trailer may reduce fuel economy at any speed.
- Adding certain accessories to your vehicle (for example bug deflectors, rollbars, light bars, running boards, ski racks or luggage racks) may reduce fuel economy.
- To maximize the fuel economy, drive with the tonneau cover installed (if equipped).
- Using fuel blended with alcohol may lower fuel economy.

# Driving Hints

- Fuel economy may decrease with lower temperatures during the first 5–10 mi (12–16 km) of driving.
- Driving on flat terrain offers improved fuel economy as compared to driving on hilly terrain.
- Transmissions give their best fuel economy when operated in the top cruise gear and with steady pressure on the gas pedal.
- Four-wheel-drive operation (if equipped) is less fuel efficient than two-wheel-drive operation.
- Close the windows for high-speed driving.

## DRIVING THROUGH WATER

### WARNING



Do not drive through flowing or deep water as you may lose control of your vehicle.

**Note:** *Driving through standing water can cause vehicle damage.*

**Note:** *Engine damage can occur if water enters the air filter.*

Before driving through standing water, check the depth. Never drive through water that is higher than the bottom of the wheel hubs.

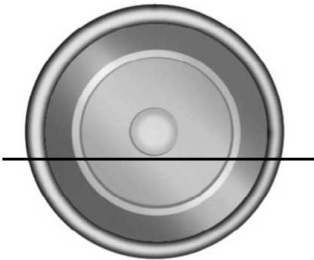

E176913

When driving through standing water, drive very slowly and do not stop your vehicle. Your brake performance and traction may be limited. After driving through water and as soon as it is safe to do so:

- Lightly press the brake pedal to dry the brakes and to check that they work.
- Check that the horn works.
- Check that the exterior lights work.
- Turn the steering wheel to check that the steering power assist works.

## FLOOR MATS

### WARNINGS



Use a floor mat designed to fit the footwell of your vehicle that does not obstruct the pedal area. Failure to follow this instruction could result in the loss of control of your vehicle, personal injury or death.



Pedals that cannot move freely can cause loss of vehicle control and increase the risk of serious personal injury.



Secure the floor mat to both retention devices so that it cannot slip out of position and interfere with the pedals. Failure to follow this instruction could result in the loss of control of your vehicle, personal injury or death.



Do not place additional floor mats or any other covering on top of the original floor mats. This could result in the floor mat interfering with the operation of the pedals. Failure to follow this instruction could result in the loss of control of your vehicle, personal injury or death.



Always make sure that objects cannot fall into the driver foot well while your vehicle is moving. Objects that are loose can become trapped under the pedals causing a loss of vehicle control.

# Driving Hints



E142666

To install the floor mats, position the floor mat eyelet over the retention post and press down to lock in position.

To remove the floor mat, reverse the installation procedure.

**Note:** Regularly check the floor mats to make sure they are secure.

## SNOWPLOWING

Ford recommends that the Super Duty F-Series used for snow removal include the snowplow package option.

### Installing the Snowplow

Weight limits and guidelines for selecting and installing the snowplow are in the Ford Truck Body Builders Layout Book, snowplow section, found at [www.fleet.ford.com/truckbbas](http://www.fleet.ford.com/truckbbas). A typical installation affects the following:

- Certification to government safety laws such as occupant protection and airbag deployment, braking, and lighting. Look for an Alterer's Label on the vehicle from the snowplow installer certifying that the installation meets all applicable Federal Motor Vehicle Safety Standards (FMVSS).
- The Total Accessory Reserve Capacity (TARC) is on the lower right side of the vehicle's Safety Compliance Certification Label. This applies to Ford-completed vehicles of 10,000 lb (4,536 kg) GVWR or less. This is the weight of permanently-attached auxiliary equipment, such as snowplow frame-mounting hardware, that can be added to the vehicle and satisfy Ford compliance certification to FMVSS. Exceeding this weight may require the auxiliary equipment installer additional safety certification responsibility. The Front Accessory Reserve Capacity (FARC) is for customer convenience.
- Rear ballast weight behind the rear axle may be required to prevent exceeding the FGAWR, and provide front-to-rear weight balance for proper braking and steering.
- Front wheel toe may require re-adjustment to prevent premature uneven tire wear. Specifications are in the Ford Workshop Manual.
- Headlight aim may require re-adjustment.

# Driving Hints

- The tire air pressures recommended for general driving are on the vehicle's Safety Certification Label. The maximum cold inflation pressure for the tire and associated load rating is on the tire sidewall. Tire air pressure may require re-adjustment within these pressure limits to accommodate the additional weight of the snowplow installation.
- Federal and some local regulations require additional exterior lamps for snowplow-equipped vehicles. Consult your authorized dealer for additional information.

## Operating the Vehicle with the Snowplow Attached

**Note:** *Do not use your vehicle for snow removal until you have driven at least 500 mi (800 km).*

Ford recommends vehicle speed does not exceed 45 mph (72 km/h) when snowplowing.

The attached snowplow blade restricts airflow to the radiator, and may cause the engine to run at a higher temperature: Attention to engine temperature is especially important when outside temperatures are above freezing. Angle the blade to maximize airflow to the radiator and monitor engine temperature to determine whether a left or right angle provides the best performance.

Follow the severe duty schedule in your Scheduled Maintenance information for engine oil and transmission fluid change intervals.

## Snowplowing with your Airbag Equipped Vehicle

### WARNINGS



Do not attempt to service, repair, or modify the airbag supplemental restraint system (SRS) or its fuses. Contact an authorized dealer.



Additional equipment for example snowplow equipment may affect the performance of the airbag sensors increasing the risk of injury. Please refer to the Body Builders Layout Book for instructions about the appropriate installation of additional equipment.



All occupants of the vehicle, including the driver, should always properly wear their seatbelt, even when provided with an airbag supplemental restraint system (SRS).

Your vehicle is equipped with a driver and passenger airbag supplemental restraint system. The supplemental restraint system will activate in certain frontal and offset frontal collisions when the vehicle sustains sufficient frontal deceleration.

Careless or high speed driving while plowing snow that results in sufficient vehicle decelerations can deploy the airbags. Such driving also increases the risk of accidents.

Never remove or defeat the tripping mechanisms designed into the snow removal equipment by its manufacturer. Doing so may cause damage to the vehicle and the snow removal equipment as well as possible airbag deployment.

## Engine temperature while plowing

When driving with a plow, your engine may run at a higher temperature than normal because the attached snowplow blade will restrict airflow to the radiator.



# Driving Hints

---

- If you are driving more than 15 mi (24 km) at temperatures above freezing, angle the plow blade either full left or full right to provide maximum airflow to the radiator.
- If you are driving less than 15 mi (24 km) at speeds up to 45 mph (72 km/h) in cold weather, you will not need to worry about blade position to provide maximum airflow.

## Transmission operation while plowing

### WARNING



Do not spin the wheels at over 34 mph (55 km/h). The tires may fail and injure a passenger or bystander.

- Shift transfer case to **4L** (4WD Low) when plowing in small areas at speeds below 5 mph (8 km/h).
- Shift transfer case to **4H** (4WD High) when plowing larger areas or light snow at higher speeds. Do not exceed 15 mph (24 km/h).
- Do not shift the transmission from a forward gear to **R** (Reverse) until the engine is at idle and the wheels have stopped.

# Roadside Emergencies

---

## ROADSIDE ASSISTANCE

### Vehicles Sold in the United States: Getting Roadside Assistance

To fully assist you should you have a vehicle concern, Ford Motor Company offers a complimentary roadside assistance program. This program is separate from the New Vehicle Limited Warranty.

The service is available:

- 24 hours a day, seven days a week.
- For the coverage period listed on the Roadside Assistance Card included in your Owner's Manual portfolio.

Roadside Assistance covers:

- A flat tire change with a good spare (except vehicles supplied with a tire inflation kit).
- Battery jump start.
- Lock-out assistance (key replacement cost is the customer's responsibility).
- Fuel delivery — independent service contractors, if not prohibited by state, local or municipal law, shall deliver up to 2 gal (8 L) of gasoline or 5 gal (20 L) of diesel fuel to a disabled vehicle. Roadside Assistance limits fuel delivery service to two no-charge occurrences within a 12-month period.
- Winch out — available within 100 ft (30 m) of a paved or county maintained road, no recoveries.

- Towing — independent service contractors, if not prohibited by state, local or municipal law, shall tow Ford eligible vehicles to an authorized dealer within 35 mi (56 km) of the disablement location or to the nearest authorized dealer. If a member requests a tow to an authorized dealer that is more than 35 mi (56 km) from the disablement location, the member shall be responsible for any mileage costs in excess of 35 mi (56 km).
- Roadside Assistance includes up to \$200 for a towed trailer if the disabled eligible vehicle requires service at the nearest authorized dealer. If the towing vehicle is operational but the trailer is not, then the trailer does not qualify for any roadside services.

### Vehicles Sold in the United States: Using Roadside Assistance

Complete the roadside assistance identification card and place it in your wallet for quick reference. This card is in the owner's information portfolio in the glove compartment.

United States vehicle customers who require Roadside Assistance, call 1-800-241-3673.

If you need to arrange roadside assistance for yourself, Ford Motor Company reimburses a reasonable amount for towing to the nearest dealership within 35 mi (56 km). To obtain reimbursement information, United States vehicle customers call 1-800-241-3673. Customers need to submit their original receipts.

# Roadside Emergencies

## Vehicles Sold in Canada: Getting Roadside Assistance

To fully assist you should you have a vehicle concern, Ford Motor Company of Canada, Limited offers a complimentary roadside assistance program. This program is eligible within Canada or the continental United States.

Canadian customers who require roadside assistance, call 1-800-665-2006.

## Vehicles Sold in Canada: Using Roadside Assistance

Complete the roadside assistance identification card and place it in your wallet for quick reference.

In Canada, this card is found in the Warranty Guide in the glove compartment of your vehicle.

## Vehicles Sold in Canada: Roadside Assistance Program Coverage

The service is available 24 hours a day, seven days a week.

Canadian roadside coverage and benefits may differ from the U.S. coverage.

If you require more information, please refer to the coverage section of your warranty guide, call us in Canada at 1-800-665-2006, or visit our website at [www.ford.ca](http://www.ford.ca).

## HAZARD FLASHERS

**Note:** *The hazard flashers operate when the ignition is in any position, or if the key is not in the ignition. If used when the vehicle is not running, the battery loses charge. As a result, there may be insufficient power to restart your vehicle.*



The flasher control is on the instrument panel. Use your hazard flashers when your vehicle is creating a safety hazard for other motorists.

- Press the flasher control and all front and rear direction indicators flash.
- Press the button again to switch them off.

## FUEL SHUTOFF

### WARNING



If your vehicle has been involved in a crash, have the fuel system checked. Failure to follow this instruction could result in fire, personal injury or death.

**Note:** *When you try to restart your vehicle after a fuel shutoff, the vehicle makes sure that various systems are safe to restart. Once the vehicle determines the systems are safe, then the vehicle allows you to restart.*

**Note:** *In the event that your vehicle does not restart after your third attempt, contact a qualified technician.*

The fuel pump shutoff stops the flow of fuel to the engine in the event of a moderate to severe crash. Not every impact causes a shutoff.

Should your vehicle shut off after a crash, you may restart your vehicle.

If your vehicle has a key system:

1. Switch off the ignition.
2. Switch to start position.
3. Switch off the ignition.
4. Switch on the ignition to re-enable the fuel pump.
5. If the vehicle does not start, repeat steps 1 through 4.

# Roadside Emergencies

If your vehicle has a push button start system:

1. Press **START/STOP** to switch off your vehicle.
2. Press the brake pedal and **START/STOP** to switch on your vehicle.
3. Remove your foot from the brake pedal and press **START/STOP** to switch off your vehicle.
4. You can attempt to start the vehicle by pressing the brake pedal and **START/STOP**, or press **START/STOP** without pressing the brake pedal.
5. If the vehicle does not start, repeat steps 1 through 4.

## JUMP STARTING THE VEHICLE

### WARNINGS



Batteries normally produce explosive gases which can cause personal injury. Therefore, do not allow flames, sparks or lighted substances to come near the battery. When working near the battery, always shield your face and protect your eyes. Always provide correct ventilation.



Keep batteries out of reach of children. Batteries contain sulfuric acid. Avoid contact with skin, eyes or clothing. Shield your eyes when working near the battery to protect against possible splashing of acid solution. In case of acid contact with skin or eyes, flush immediately with water for a minimum of 15 minutes and get prompt medical attention. If acid is swallowed, call a physician immediately.



Use only adequately sized cables with insulated clamps.

## Preparing Your Vehicle

Do not attempt to push-start your automatic transmission vehicle.

**Note:** *Attempting to push-start a vehicle with an automatic transmission may cause transmission damage.*

**Note:** *Use only a 12-volt supply to start your vehicle.*

**Note:** *Do not disconnect the battery of the disabled vehicle as this could damage the vehicle electrical system.*

Park the booster vehicle close to the hood of the disabled vehicle, making sure the two vehicles do not touch.

## Connecting the Jumper Cables

### WARNINGS



Do not attach the cables to fuel lines, engine rocker covers, the intake manifold or electrical components as grounding points. Stay clear of moving parts. To avoid reverse polarity connections, make sure that you correctly identify the positive (+) and negative (-) terminals on both the disabled and booster vehicles before connecting the cables.



Do not attach the end of the positive cable to the studs or L-shaped eyelet located above the positive (+) terminal of your vehicle's battery. High current may flow through and cause damage to the fuses.



Do not connect the end of the second cable to the negative (-) terminal of the battery to be jumped. A spark may cause an explosion of the gases that surround the battery.

**Note:** *In the illustration, the bottom vehicle represents the booster vehicle.*

# Roadside Emergencies

## Jump Starting

1. Start the engine of the booster vehicle and rev the engine moderately, or press the accelerator gently to keep your engine speed between 2000 and 3000 RPM, as shown in your tachometer.
2. Start the engine of the disabled vehicle.
3. Once the disabled vehicle has been started, run both vehicle engines for an additional three minutes before disconnecting the jumper cables.

## Removing the Jumper Cables

Remove the jumper cables in the reverse order that they were connected.

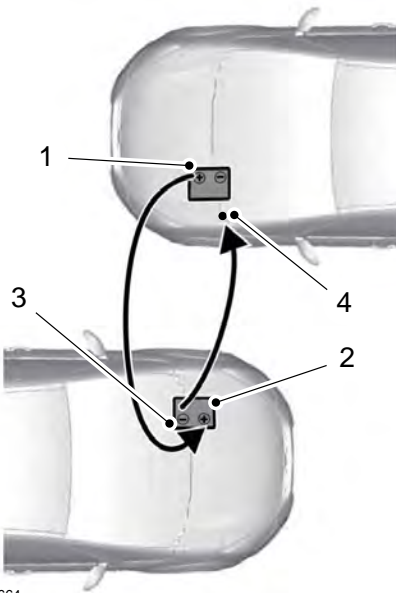

E142664

1. Connect the positive (+) jumper cable to the positive (+) terminal of the discharged battery.
2. Connect the other end of the positive (+) cable to the positive (+) terminal of the booster vehicle battery.
3. Connect the negative (-) cable to the negative (-) terminal of the booster vehicle battery.
4. Make the final connection of the negative (-) cable to an exposed metal part of the stalled vehicle's engine, away from the battery and the fuel injection system, or connect the negative (-) cable to a ground connection point if available.

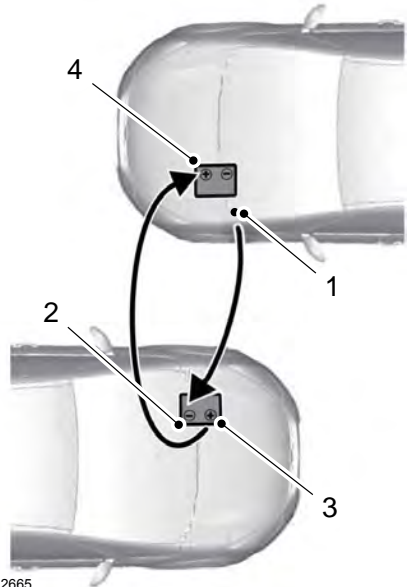

E142665

1. Remove the negative (-) jumper cable from the disabled vehicle.

# Roadside Emergencies

2. Remove the jumper cable on the negative (-) terminal of the booster vehicle battery.
3. Remove the jumper cable from the positive (+) terminal of the booster vehicle battery.
4. Remove the jumper cable from the positive (+) terminal of the disabled vehicle battery.
5. Allow the engine to idle for at least one minute.

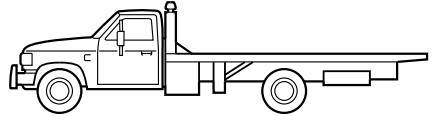
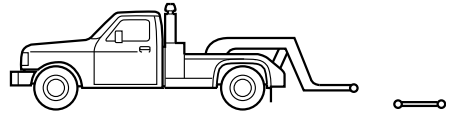

## POST-CRASH ALERT SYSTEM

The system flashes the direction indicators and sounds the horn (intermittently) in the event of a serious impact that deploys an airbag (front, side, side curtain or Safety Canopy) or the seatbelt pretensioners.

The horn and indicators turn off when:

- You press the hazard control button.
- You press the panic button on the remote entry transmitter (if equipped).
- Your vehicle runs out of power.
- Sounding of the horn is only enabled in specific markets.

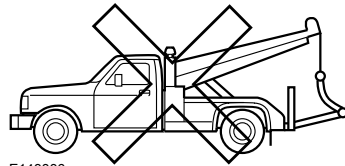

E143886

If you need to tow your vehicle, contact a professional towing service or, if you are a member of a roadside assistance program, your roadside assistance service provider.

We recommend the use of a wheel lift and dollies or flatbed equipment to tow your vehicle. Do not tow with a slingbelt. We do not approve a slingbelt towing procedure. If you tow your vehicle incorrectly, or by any other means, vehicle damage may occur.

We produce a towing manual for all authorized tow truck operators. Have your tow truck operator refer to this manual for proper hook-up and towing procedures for your vehicle.

It is acceptable to have your two-wheel drive vehicle towed with the front wheels on the ground (without dollies) and the rear wheels off the ground.

## TRANSPORTING THE VEHICLE

### WARNINGS



Block the wheels to help prevent the vehicle from moving.



Unexpected and possibly sudden vehicle movement may occur if you do not take these precautions.

# Roadside Emergencies

We recommend towing a four-wheel drive vehicle with all wheels off the ground, such as using a wheel lift and dollies or flatbed equipment. However, it is acceptable to use a wheel lift to raise the rear of your vehicle so long as, depending on vehicle configuration, you perform the following before towing:

- If your vehicle has a manual-shift transfer case, make sure the front wheel hub locks are in the **FREE** position before towing.
- If your vehicle has an electronic shift-on-the-fly transfer case, make sure you switch the four-wheel drive control to the **2H** position before towing.

**Note:** *Towing an electronic shift-on-the-fly four-wheel drive vehicle with the front wheels on the ground without disengaging the front hubs may cause damage to the automatic transmission.*

**Note:** *Towing a two-wheel drive vehicle or an electronic shift-on-the-fly four-wheel drive vehicle with the rear wheels on the ground for more than 50 mi (80 km) or faster than 35 mph (56 km/h) may cause damage to the automatic transmission.*

**Note:** *Using wheel lift equipment to tow a dual rear wheel vehicle requires removing an outer rear wheel before towing.*

## TOWING POINTS

### WARNINGS



Using recovery hooks is dangerous and should only be done by a person familiar with proper vehicle recovery safety practices. Improper use of recovery hooks may cause hook failure or separation from the vehicle and could result in serious injury or death.

### WARNINGS



Always slowly remove the slack from the recovery strap prior to pulling. Failure to do so can introduce significantly higher loads which can cause the recovery hooks to break off, or the recovery strap to fail which can cause serious injury or death.



Never link two straps together with a clevis pin. These heavy metal objects could become projectiles if the strap breaks and can cause serious injury or death.

Your vehicle comes equipped with frame-mounted front recovery hooks. These hooks should never have a load applied to them greater than the gross vehicle weight rating of your vehicle.

Before using recovery hooks:

- Make sure all attaching points are secure and capable of withstanding the applied load.
- Never use chains, cables or tow straps with metal hook ends.
- Only use recovery straps that have a minimum breaking strength two to three times the gross vehicle weight of the stuck vehicle.
- Make sure the recovery strap is in good condition and free of visible cuts, tears or damage.
- Use a damper device such as a tarp, heavy blanket or piece of carpet draped over the recovery strap to help absorb the energy in the event the strap breaks.
- Make sure the stuck vehicle is not loaded heavier than its gross vehicle weight rating specified on the certification label.

# Roadside Emergencies

---

- Always align the tow vehicle and stuck vehicle in a straight line (within 10 degrees).
- Keep bystanders to the **sides** of the vehicle, at a distance of at least twice the length of the recovery strap. This helps avoid injury from the hazard of a recovery hook or strap breaking, or a vehicle lurching into their path.



# Customer Assistance

## GETTING THE SERVICES YOU NEED

Warranty repairs to your vehicle must be performed by an authorized dealer. While any authorized dealer handling your vehicle line will provide warranty service, we recommend you return to your selling authorized dealer who wants to ensure your continued satisfaction.

Please note that certain warranty repairs require special training and equipment, so not all authorized dealers are authorized to perform all warranty repairs. This means that, depending on the warranty repair needed, you may have to take your vehicle to another authorized dealer.

A reasonable time must be allowed to perform a repair after taking your vehicle to the authorized dealer. Repairs will be made using Ford or Motorcraft® parts, or remanufactured or other parts that are authorized by Ford.

### Away From Home

If you are away from home when your vehicle needs service, contact the Ford Customer Relationship Center or use the online resources listed below to find the nearest authorized dealer.

In the United States:

#### Mailing address

Ford Motor Company  
Customer Relationship Center  
P.O. Box 6248  
Dearborn, MI 48126

#### Telephone

1-800-392-3673 (FORD)  
(TDD for the hearing impaired:  
1-800-232-5952)

Additional information and resources are available online:

Website
<a href="http://www.owner.ford.com">www.owner.ford.com</a>

These are some of the items that can be found online:

- U.S. dealer locator by Dealer Name, City/State or Zip Code.
- Owner Manuals.
- Maintenance Schedules.
- Recalls.
- Ford Extended Service Plans.
- Ford Genuine Accessories.
- Service specials and promotions.

In Canada:

#### Mailing address

Customer Relationship Centre  
Ford Motor Company of Canada, Limited  
P.O. Box 2000  
Oakville, Ontario L6K 0C8

#### Telephone

1-800-565-3673 (FORD)

Website
<a href="http://www.ford.ca">www.ford.ca</a>

#### Twitter

@FordServiceCA (English Canada)  
@FordServiceQC (Quebec)

#### Additional Assistance

If you have questions or concerns, or are unsatisfied with the service you are receiving, follow these steps:

1. Contact your Sales Representative or Service Advisor at your selling or servicing authorized dealer.

# Customer Assistance

---

2. If your inquiry or concern remains unresolved, contact the Sales Manager, Service Manager or Customer Relations Manager.
3. If you require assistance or clarification on Ford Motor Company policies, please contact the Ford Customer Relationship Center.

In order to help us serve you better, please have the following information available when contacting a Customer Relationship Center:

- Vehicle Identification Number.
- Your telephone number (home and business).
- The name of the authorized dealer and city where located.
- The vehicle's current odometer reading.

In some states within the United States, you must directly notify Ford in writing before pursuing remedies under your state's warranty laws, and Ford is also allowed a final repair attempt.

Additionally, in some states within the United States, a consumer has the option of submitting a warranty dispute to the BBB Auto Line before taking action under the Magnuson-Moss Warranty Act, or to the extent allowed by state law, before pursuing replacement or repurchase remedies provided by certain state laws. This dispute handling procedure is not required prior to enforcing state created rights or other rights which are independent of the Magnuson-Moss Warranty Act or state replacement or repurchase laws.

## IN CALIFORNIA (U.S. ONLY)

California Civil Code Section 1793.2(d) requires that, if a manufacturer or its representative is unable to repair a motor vehicle to conform to the vehicle's applicable express warranty after a reasonable number of attempts, the manufacturer shall be required to either replace the vehicle with one substantially identical or repurchase the vehicle and reimburse the buyer in an amount equal to the actual price paid or payable by the consumer (less a reasonable allowance for consumer use). The consumer has the right to choose whether to receive a refund or replacement vehicle.

California Civil Code Section 1793.22(b) presumes that the manufacturer has had a reasonable number of attempts to conform the vehicle to its applicable express warranties if, within the first 18 months of ownership of a new vehicle or the first 18,000 mi (29,000 km), whichever occurs first:

1. Two or more repair attempts are made on the same non-conformity likely to cause death or serious bodily injury OR
2. Four or more repair attempts are made on the same nonconformity (a defect or condition that substantially impairs the use, value or safety of the vehicle) OR
3. The vehicle is out of service for repair of nonconformities for a total of more than 30 calendar days (not necessarily all at one time).

In the case of 1 or 2 above, the consumer must also notify the manufacturer of the need for the repair of the nonconformity at the following address:

Ford Motor Company  
16800 Executive Plaza Drive  
Mail Drop 3NE-B  
Dearborn, MI 48126

# Customer Assistance

---

You are required to submit your warranty dispute to BBB AUTO LINE before asserting in court any rights or remedies conferred by California Civil Code Section 1793.22(b). You are also required to use BBB AUTO LINE before exercising rights or seeking remedies created by the Federal Magnuson-Moss Warranty Act, 15 U.S.C. sec. 2301 et seq. If you choose to seek redress by pursuing rights and remedies not created by California Civil Code Section 1793.22(b) or the Magnuson-Moss Warranty Act, resort to BBB AUTO LINE is not required by those statutes.

## **THE BETTER BUSINESS BUREAU (BBB) AUTO LINE PROGRAM (U.S. ONLY)**

Your satisfaction is important to Ford Motor Company and to your dealer. If a warranty concern has not been resolved using the three-step procedure outlined earlier in this chapter in the Getting the Services you need section, you may be eligible to participate in the BBB AUTO LINE program.

The BBB AUTO LINE program consists of two parts – mediation and arbitration. During mediation, a representative of the BBB will contact both you and Ford Motor Company to explore options for settlement of the claim. If an agreement is not reached during mediation or you do not want to participate in mediation, and if your claim is eligible, you may participate in the arbitration process. An arbitration hearing will be scheduled so that you can present your case in an informal setting before an impartial person. The arbitrator will consider the testimony provided and make a decision after the hearing.

Disputes submitted to the BBB AUTO LINE program are usually decided within forty days after you file your claim with the BBB. You are not bound by the decision, and may reject the decision and proceed to court where all findings of the BBB Auto Line dispute, and decision, are admissible in the court action. Should you choose to accept the BBB AUTO LINE decision, Ford is then bound by the decision, and must comply with the decision within 30 days of receipt of your acceptance letter.

**BBB AUTO LINE Application:** Using the information provided below, please call or write to request a program application. You will be asked for your name and address, general information about your new vehicle, information about your warranty concerns, and any steps you have already taken to try to resolve them. A Customer Claim Form will be mailed that will need to be completed, signed and returned to the BBB along with proof of ownership. Upon receipt, the BBB will review the claim for eligibility under the Program Summary Guidelines.

**You can get more information by calling BBB AUTO LINE at 1-800-955-5100, or writing to:**

**BBB AUTO LINE  
3033 Wilson Boulevard, Suite 600  
Arlington, Virginia 22201**

BBB AUTO LINE applications can also be requested by calling the Ford Motor Company Customer Relationship Center at 1-800-392-3673.

**Note:** *Ford Motor Company reserves the right to change eligibility limitations, modify procedures, or to discontinue this process at any time without notice and without obligation.*

# Customer Assistance

---

## UTILIZING THE MEDIATION/ARBITRATION PROGRAM (CANADA ONLY)

For vehicles delivered to authorized Canadian dealers. In those cases where you continue to feel that the efforts by Ford of Canada and the authorized dealer to resolve a factory-related vehicle service concern have been unsatisfactory, Ford of Canada participates in an impartial third party mediation/arbitration program administered by the Canadian Motor Vehicle Arbitration Plan (CAMVAP).

The CAMVAP program is a straight forward and relatively speedy alternative to resolve a disagreement when all other efforts to produce a settlement have failed. This procedure is without cost to you and is designed to eliminate the need for lengthy and expensive legal proceedings.

In the CAMVAP program, impartial third-party arbitrators conduct hearings at mutually convenient times and places in an informal environment. These impartial arbitrators review the positions of the parties, make decisions and, when appropriate, render awards to resolve disputes. CAMVAP decisions are fast, fair, and final as the arbitrator's award is binding on both you and Ford of Canada.

CAMVAP services are available in all Canadian territories and provinces. For more information, without charge or obligation, call your CAMVAP Provincial Administrator directly at 1-800-207-0685 or visit [www.camvap.ca](http://www.camvap.ca).

## GETTING ASSISTANCE OUTSIDE THE U.S. AND CANADA

Before exporting your vehicle to a foreign country, contact the appropriate foreign embassy or consulate. These officials can inform you of local vehicle registration regulations and where to find unleaded fuel or petrol/gas engines or the proper sulfur fuel for diesel engines.

If you cannot find the proper fuel recommended for your vehicle, contact our Customer Relationship Center.

The use of improper fuels in your vehicle without proper conversion may damage the effectiveness of your emission control system and may cause engine knocking or serious engine damage. Ford Motor Company or Ford of Canada is not responsible for any damage caused by use of improper fuel. Using improper fuels may also result in difficulty importing your vehicle back into the United States.

If your vehicle must be serviced while you are traveling or living in Asia-Pacific Region, Sub-Saharan Africa, U.S. Virgin Islands and/or Puerto Rico, Central America, the Caribbean, and Israel and the Middle East, contact the nearest authorized dealer. If the authorized dealer cannot help you, contact the corresponding Ford Customer Assistance Center:

**FORD MOTOR COMPANY**  
**Customer Relationship Centers in:**

## Customer Assistance

Customer Relationship Center	Phone	Fax	E-mail
Asia Pacific	N/A	N/A	apemrc@ford.com
Caribbean and Central America	+1 313 594 4857	-	expcac@ford.com
Middle East	Ford 80004443673	971 4 3327 266	menacac@ford.com
	Lincoln 80004441067		
	UAE 80004441066		
	Saudi Arabia 8008443673		
	Mobily and Zain cell phone users in Saudi 800850078		
Puerto Rico and U.S. Virgin Islands	+1-800-841-3673	N/A	prcac@ford.com
Sub-Saharan Africa	+1-313-594-4857	N/A	ssacrc@ford.com
South Korea	+82-02-1600-6003	N/A	infokr1@ford.com or infokr@lincoln.com

If you buy your vehicle in North America and then relocate to any of the above locations, register your vehicle identification number (VIN) and new address with Ford Global Trade Services by emailing, [expcso@ford.com](mailto:expcso@ford.com).

If you are in another foreign country, contact the nearest authorized dealer. In the event your inquiry is unresolved, communicate your concern with the dealership's Sales Manager, Service Manager or Customer Relations Manager. If you require additional assistance or clarification, please contact the respective Customer Relationship Center as previously listed.

**Customers in the U.S. should call 1-800-392-3673.**

### ORDERING ADDITIONAL OWNER'S LITERATURE

To order the publications in this portfolio, contact Helm, Incorporated at:

HELM, INCORPORATED  
47911 Halyard Drive  
Plymouth, Michigan 48170  
Attention: Customer Service

Or to order a free publication catalog, call toll free: 1-800-782-4356

Monday-Friday 8:00 a.m. - 6:00 p.m. EST

## Customer Assistance

---

Helm, Incorporated can also be reached by their website:

[www.helminc.com](http://www.helminc.com)

(Items in this catalog may be purchased by credit card, check or money order.)

### **Obtaining a French Owner's Manual**

French Owner's Manual can be obtained from your authorized dealer or by contacting Helm, Incorporated using the contact information listed previously in this section.

### **REPORTING SAFETY DEFECTS (U.S. ONLY)**



E142557

If you believe that your vehicle has a defect which could cause a crash or could cause injury or death, you should immediately inform the National Highway Traffic Safety Administration (NHTSA) in addition to notifying Ford Motor Company.

If NHTSA receives similar complaints, it may open an investigation, and if it finds that a safety defect exists in a group of vehicles, it may order a recall and remedy campaign. However, NHTSA cannot become involved in individual problems between you, your dealer, or Ford Motor Company.

To contact NHTSA, you may call the Vehicle Safety Hotline toll-free at 1-888-327-4236 (TTY: 1-800-424-9153); go to <http://www.safercar.gov>; or write to:

Administrator

1200 New Jersey Avenue,  
Southeast

Washington, D.C. 20590

You can also obtain other information about motor vehicle safety from <http://www.safercar.gov>.

### **REPORTING SAFETY DEFECTS (CANADA ONLY)**

If you believe that your vehicle has a defect which could cause a crash or could cause injury or death, you should immediately inform Transport Canada and Ford of Canada.

# Customer Assistance

---

<b>Transport Canada Contact Information</b>	
Website	<a href="http://www.tc.gc.ca/eng/motorvehiclesafety/reporting-defects-motor-vehicles.html">http://www.tc.gc.ca/eng/motorvehiclesafety/reporting-defects-motor-vehicles.html</a> (English)
Website	<a href="http://www.tc.gc.ca/fra/securiteautomobile/signaler-defauts-vehicules-automobiles.html">http://www.tc.gc.ca/fra/securiteautomobile/signaler-defauts-vehicules-automobiles.html</a> (French)
Phone	1-800-333-0510

<b>Ford of Canada Contact Information</b>	
Website	<a href="http://www.ford.ca">www.ford.ca</a>
Phone	1-800-565-3673

# Fuses

## FUSE SPECIFICATION CHART

### Power Distribution Box

#### WARNINGS



Always disconnect the battery before servicing high current fuses.



To reduce risk of electrical shock, always replace the cover to the power distribution box before reconnecting the battery or refilling fluid reservoirs.

The power distribution box is in the engine compartment. It has high-current fuses that protect your vehicle's main electrical systems from overloads.

If the battery has been disconnected and reconnected, some features will need to be reset. See **Changing the 12V Battery** (page 353).

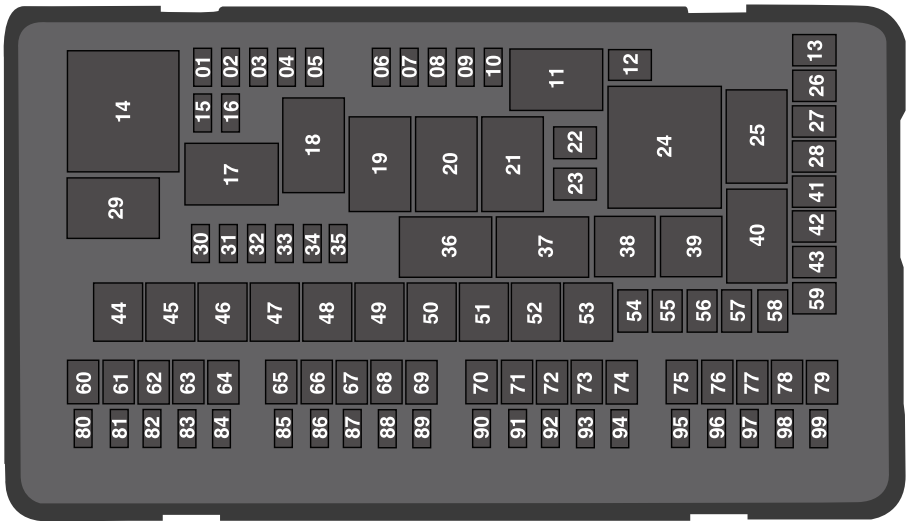

E252492



# Fuses

Fuse or Relay Number	Fuse Rating	Protected Components
1	20A <sup>1</sup>	Powertrain control module.
2	20A <sup>1</sup>	Emissions - malfunction indicator lamp.
3	20A <sup>1</sup>	Cooling fan. A/C compressor. Engine brake.
4	20A <sup>1</sup>	Noise suppression cap. Mass air flow sensor. Emissions. Glow plugs. Urea.
5	15A <sup>1</sup>	Compressed natural gas fuel control module. Fuel sensor.
6	—	Not used.
7	—	Not used.
8	—	Not used.
9	—	Not used.
10	15A <sup>1</sup>	Heated exterior mirrors.
11	—	Compressed natural gas relay.
12	40A <sup>2</sup>	Heated rear window.
13	—	Not used.
14	—	Powertrain control module relay.
15	20A <sup>1</sup>	Horn.
16	10A <sup>1</sup>	A/C clutch relay power.
17	—	Rear heated window and heated mirrors relay.
18	—	Trailer park lamp relay.
19	—	Not used.

# Fuses

Fuse or Relay Number	Fuse Rating	Protected Components
20	—	Supplemental air heater bank #1 relay.
21	—	Not used.
22	—	Not used.
23	—	Not used.
24	—	Cooling fan relay. Supplemental air heater bank #3 relay.
25	—	Glow plug module power relay.
26	—	Not used.
27	30A <sup>2</sup>	Trailer tow battery charge relay (if equipped).
28	—	Not used.
29	—	Run-start relay.
30	10A <sup>1</sup>	4x4 module.
31	5A <sup>1</sup>	Adaptive cruise control. Run-start.
32	5A <sup>1</sup>	Anti-lock brake system module. Run-start.
33	10A <sup>1</sup>	Powertrain control module - ignition status power run. Run-start. Engine control module. Transmission control module.
34	10A <sup>1</sup>	Blind spot information system. Run-start. Front camera. Rear camera.
35	—	Not used.
36	—	Blower motor relay.
37	—	Trailer tow battery charge relay (only on non-trailer brake controller vehicles).
38	—	A/C compressor clutch relay.

## Fuses

Fuse or Relay Number	Fuse Rating	Protected Components
39	—	Horn relay.
40	—	Supplemental air heater bank #2 relay.
41	25A <sup>2</sup>	Glow plugs.
42	40A <sup>2</sup>	Trailer tow lighting module (if equipped).
43	40A <sup>2</sup>	Front blower motor.
44	50A <sup>3</sup>	Voltage quality. Body control module power.
45	60A <sup>3</sup>	Active front steering.
46	50A <sup>3</sup>	Supplemental air heater bank #2.
47	50A <sup>3</sup>	Cooling fan. Supplemental air heater bank #3.
48	50A <sup>3</sup>	Body control module run power 1 bus.
49	60A <sup>3</sup>	Inverter.
50	50A <sup>3</sup>	Body control module run power 2 bus.
51	60A <sup>3</sup>	Body control module B+ feed.
52	60A <sup>3</sup>	Anti-lock brake system pump.
53	50A <sup>3</sup>	Supplemental air heater bank #1.
54	30A <sup>3</sup>	Trailer brake control module.
55	30A <sup>3</sup>	Climate controlled seat module.
56	40A <sup>3</sup>	Auxiliary lighting module.
57	30A <sup>2</sup>	Power running boards.
58	30A <sup>2</sup>	Compressed natural gas fuel control module relay.

## Fuses

Fuse or Relay Number	Fuse Rating	Protected Components
59	30A <sup>2</sup>	Anti-lock brake system valve.
60	—	Not used.
61	30A <sup>2</sup>	Driver power seat.
62	20A <sup>2</sup>	Auxiliary power point #1 (instrument panel).
63	30A <sup>2</sup>	Starter motor.
64	20A <sup>2</sup>	Auxiliary power point #2.
65	30A <sup>2</sup>	Trailer tow lighting module (if equipped).
66	20A <sup>2</sup>	Auxiliary power point #3 (center console).
67	30A <sup>2</sup>	Passenger power seat.
68	20A <sup>2</sup>	Auxiliary power point #4 (USB charger, rear center console).
69	25A <sup>2</sup>	4x4 module.
70	20A <sup>2</sup>	Auxiliary power point #5 (rear center console).
71	—	Not used.
72	30A <sup>2</sup>	Trailer tow left hand/right hand stop/turn (if equipped, not present with trailer brake controller).
73	—	Not used.
74	—	Not used.
75	30A <sup>2</sup>	Fuel pump.
76	—	Not used.
77	30A <sup>2</sup>	Wiper motor.
78	—	Not used.

# Fuses

Fuse or Relay Number	Fuse Rating	Protected Components
79	30A <sup>2</sup>	Power sliding rear window.
80	25A <sup>1</sup>	4x4 module.
81	10A <sup>1</sup>	4x4 solenoid.
82	10A <sup>1</sup>	Power telescoping mirrors.
83	20A <sup>1</sup>	Rear heated seats.
84	10A <sup>1</sup>	Trailer tow backup lamps (if equipped).
85	—	Not used.
86	—	Not used.
87	—	Not used.
88	10A <sup>1</sup>	Multi contour seats.
89	—	Not used.
90	10A <sup>1</sup>	Spot light module.
91	10A <sup>1</sup>	Upfitter interface module.
92	—	Not used.
93	—	Not used.
94	15A <sup>1</sup>	Transmission control module.
95	10A <sup>1</sup>	Powertrain control module keep alive power.
96	5A <sup>1</sup>	Rain sensor.
97	10A <sup>1</sup>	Run/Start control for Auxiliary power point #5

# Fuses

Fuse or Relay Number	Fuse Rating	Protected Components
98	10A <sup>1</sup>	Alternator sense.
99	30A <sup>1</sup>	Trailer tow parking lamps.

<sup>1</sup> Micro fuse.

<sup>2</sup> M case fuse.

<sup>3</sup> J case fuse.

## Passenger Compartment Fuse Panel

**Note:** *It may be easier to access the fuse panel if you remove the finish trim piece.*

The fuse panel is in the right-hand side of the passenger footwell behind a trim panel. To remove the trim panel, pull it toward you and swing it away from the side. To reinstall it, line up the tabs with the grooves on the panel, and then push it shut.

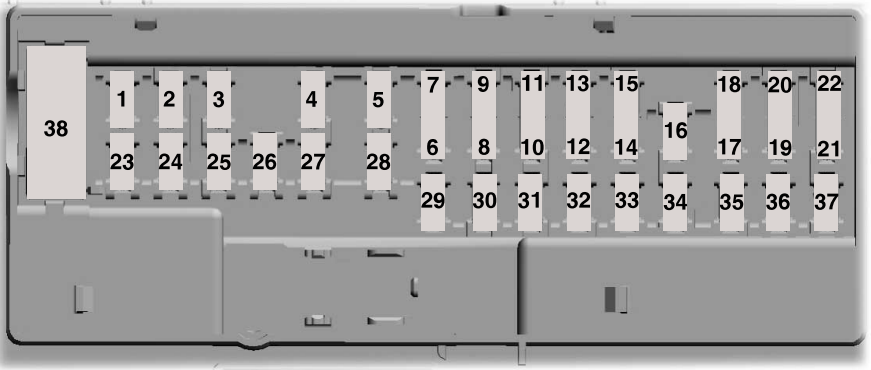

E145984

# Fuses

Fuse or Relay Number	Fuse Rating	Protected Components
1	—	Not used.
2	7.5A <sup>1</sup>	Memory seat switch (lumbar power).
3	20A <sup>1</sup>	Driver door unlock relay.
4	5A <sup>1</sup>	Aftermarket electronic brake controller. Trailer brake controller Brake On/Off. Customer access circuits.
5	—	Not used.
6	—	Not used.
7	—	Not used.
8	10A <sup>2</sup>	Driver window switch mirror fold.
9	10A <sup>2</sup>	Brake On/Off / Pressure Switch.
10	—	Not used.
11	5A <sup>2</sup>	Combined sense security module.
12	7.5A <sup>2</sup>	Front climate control module.
13	7.5A <sup>2</sup>	Instrument cluster. Smart data link. Steering column control module.
14	10A <sup>2</sup>	Extended power restraints module.
15	10A <sup>2</sup>	Smart datalink connector power.
16	15A <sup>1</sup>	Tailgate release solenoid.
17	5A <sup>2</sup>	Head-up display.
18	5A <sup>2</sup>	Push button ignition switch. Ignition switch. Key inhibit.
19	7.5A <sup>2</sup>	Transmission control switch (tow/haul). Select Shift switch.

## Fuses

Fuse or Relay Number	Fuse Rating	Protected Components
20	7.5A <sup>2</sup>	Active front steering module.
21	5A <sup>2</sup>	Head-up display. Humidity sensor.
22	5A <sup>2</sup>	Upfitter switch. Run/Start. PTO relays.
23	10A <sup>1</sup>	Accessory delay. Power windows. Moonroof. Power folding mirrors relay. Inverter. Window/moonroof switch illumination.
24	20A <sup>1</sup>	Central locking system relay.
25	30A <sup>1</sup>	Left-hand front smart window motor. Door zone module.
26	30A <sup>1</sup>	Right-hand front smart window motor. Door zone module.
27	30A <sup>1</sup>	Moonroof.
28	20A <sup>1</sup>	Sony amplifier - 10 channel.
29	—	Not used.
30	—	Not used.
31	15A <sup>1</sup>	Adjustable pedals switch.
32	10A <sup>1</sup>	SYNC. GPS module. Display. Radio frequency receiver.
33	20A <sup>1</sup>	Radio.
34	30A <sup>1</sup>	Run-start relay.
35	5A <sup>1</sup>	Extended power restraints module.



# Fuses

Fuse or Relay Number	Fuse Rating	Protected Components
36	15A <sup>1</sup>	Lane keeping system. Automatic high beam control. Auto-dimming mirrors. Rear heated seats. Camera module.
37	20A <sup>1</sup>	Heated steering wheel.
38	30A <sup>3</sup>	Rear power window switch.

<sup>1</sup>Micro 2 fuse.

<sup>2</sup>Micro 3 fuse.

<sup>3</sup>Circuit breaker.

## CHANGING A FUSE

### Fuses

#### WARNING



Always replace a fuse with one that has the specified amperage rating. Using a fuse with a higher amperage rating can cause severe wire damage and could start a fire.



E217331

If electrical components in the vehicle are not working, a fuse may have blown. Blown fuses are identified by a broken wire within the fuse. Check the appropriate fuses before replacing any electrical components.

# Fuses

## Fuse Types

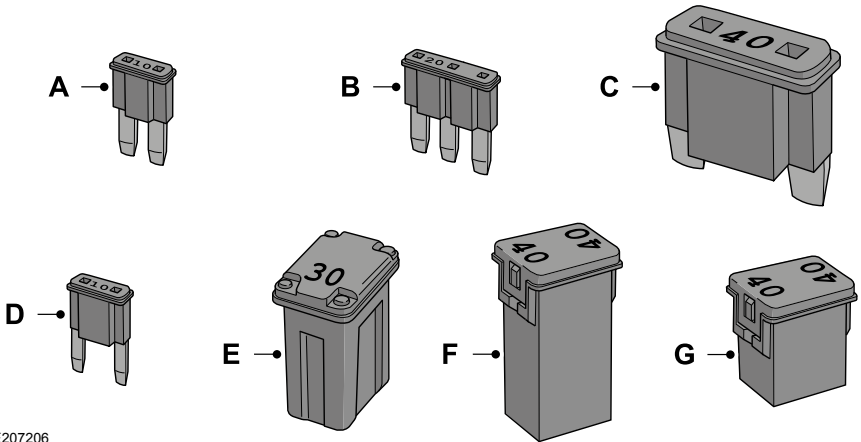

E207206

Callout	Fuse Type
A	Micro 2
B	Micro 3
C	Maxi
D	Mini
E	M Case
F	J Case
G	J Case Low Profile

# Maintenance

## GENERAL INFORMATION

Have your vehicle serviced regularly to help maintain its roadworthiness and resale value. There is a large network of authorized dealers that are there to help you with their professional servicing expertise. We believe that their specially trained technicians are best qualified to service your vehicle properly and expertly. They are supported by a wide range of highly specialized tools developed specifically for servicing your vehicle.

If your vehicle requires professional service, an authorized dealer can provide the necessary parts and service. Check your warranty information to find out which parts and services are covered.

Use only recommended fuels, lubricants, fluids and service parts conforming to specifications. Motorcraft® parts are designed and built to provide the best performance in your vehicle.

## Precautions

- Do not work on a hot engine.
- Make sure that nothing gets caught in moving parts.
- Do not work on a vehicle with the engine running in an enclosed space, unless you are sure you have enough ventilation.
- Keep all open flames and other burning material (such as cigarettes) away from the battery and all fuel related parts.

## Working with the Engine Off

1. Set the parking brake and shift to park (P).
2. Switch off the engine.
3. Block the wheels.

## Working with the Engine On

### WARNING



To reduce the risk of vehicle damage and/or personal burn injuries, do not start your engine with the air cleaner removed and do not remove it while the engine is running.

1. Set the parking brake and shift to park (P).
2. Block the wheels.

## OPENING AND CLOSING THE HOOD

1. Inside the vehicle, pull the hood release handle located under the left hand side of the instrument panel.

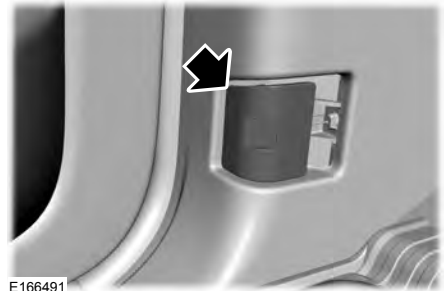

E166491

2. Go to the front of your vehicle and locate the secondary release lever under the front of the hood near the center of your vehicle.

# Maintenance

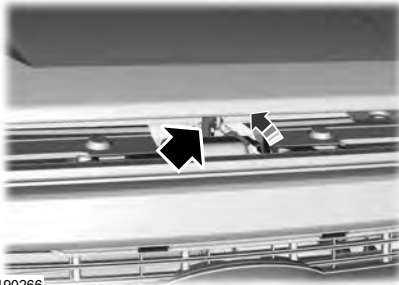

E190266

3. Raise the hood until the lift cylinders hold it open.
4. To close, lower the hood and make sure that it is closed properly and fully latched.

## UNDER HOOD OVERVIEW - 6.2L

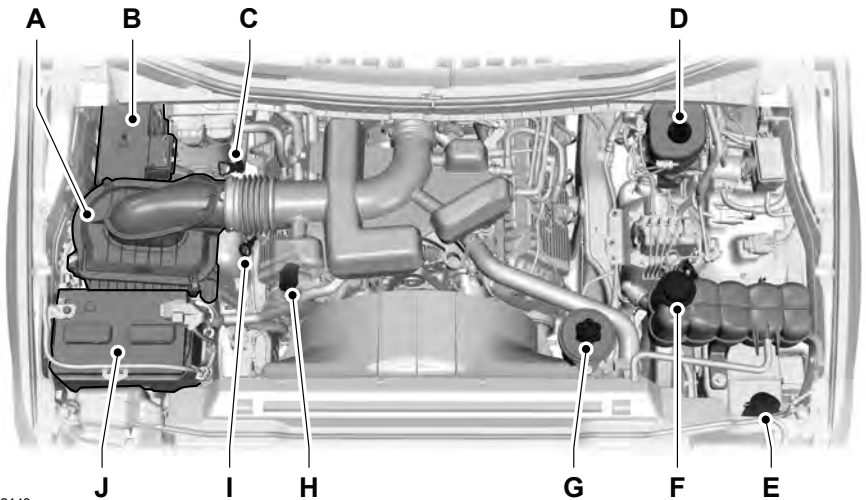

E222143

- A. Air filter. See **Changing the Engine Air Filter** (page 362).
- B. Engine compartment fuse box. See **Fuse Specification Chart** (page 317).
- C. Automatic transmission fluid dipstick. See **Automatic Transmission Fluid Check** (page 346).
- D. Brake fluid reservoir. See **Brake Fluid Check** (page 349).

# Maintenance

- E. Windshield washer fluid reservoir. See **Washer Fluid Check** (page 350).
- F. Engine coolant reservoir. See **Engine Coolant Check** (page 338).
- G. Power steering fluid reservoir. See **Power Steering Fluid Check** (page 350).
- H. Engine oil filler cap. See **Engine Oil Check** (page 333).
- I. Engine oil dipstick. See **Engine Oil Dipstick** (page 333).
- J. Battery. See **Changing the 12V Battery** (page 353).

## UNDER HOOD OVERVIEW - 6.7L DIESEL

### F-Super Duty

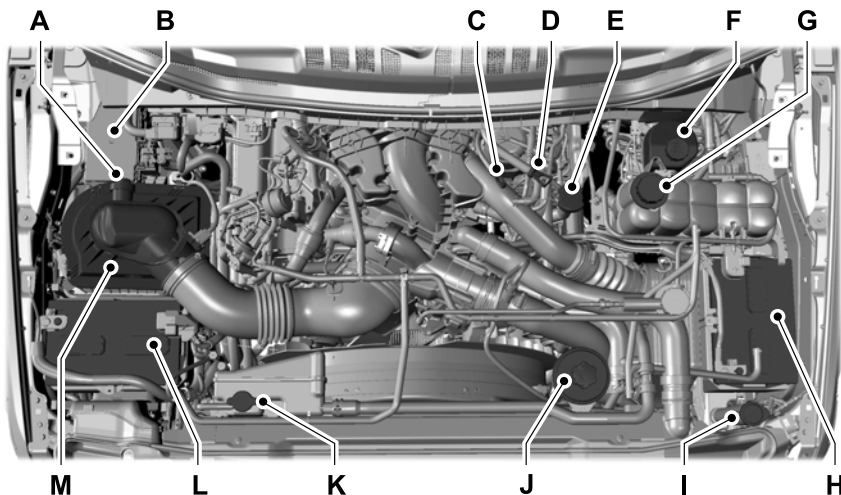

E234258

- A. Air filter restriction gauge. See **Changing the Engine Air Filter** (page 363).
- B. Engine compartment fuse box. See **Fuse Specification Chart** (page 317).
- C. Engine oil dipstick. See **Engine Oil Dipstick** (page 333).
- D. Automatic transmission fluid dipstick. See **Automatic Transmission Fluid Check** (page 346).

# Maintenance

---

- E. Engine oil fill. See **Engine Oil Check** (page 333).
- F. Brake fluid reservoir. See **Brake Fluid Check** (page 349).
- G. Engine cooling system coolant reservoir (primary high-temperature cooling system). See **Engine Coolant Check** (page 342).
- H. Battery. See **Changing the 12V Battery** (page 353).
- I. Windshield washer fluid reservoir. See **Washer Fluid Check** (page 350).
- J. Power steering fluid reservoir. See **Power Steering Fluid Check** (page 350).
- K. Secondary cooling system coolant reservoir. See **Engine Coolant Check** (page 342).
- L. Battery. See **Changing the 12V Battery** (page 353).
- M. Air filter assembly. See **Changing the Engine Air Filter** (page 363).

## Scheduled Maintenance

The recommended scheduled maintenance services are required because they are considered essential to the life and performance of your vehicle. See **Normal Scheduled Maintenance** (page 584).

Use only recommended fuel, lubricants, fluids and service parts conforming to Ford specifications. Motorcraft® parts are designed and built for best performance in your vehicle. See **Capacities and Specifications** (page 432).

## UNDER HOOD OVERVIEW - 6.8L

# Maintenance

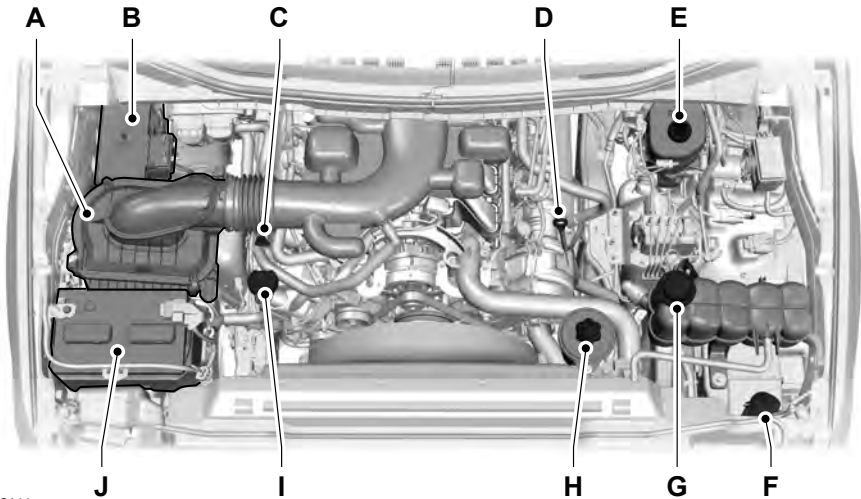

E222144

- A. Air filter. See **Changing the Engine Air Filter** (page 362).
- B. Engine compartment fuse box. See **Fuse Specification Chart** (page 317).
- C. Automatic transmission fluid dipstick. See **Automatic Transmission Fluid Check** (page 346).
- D. Engine oil dipstick. See **Engine Oil Dipstick** (page 333).
- E. Brake fluid reservoir. See **Brake Fluid Check** (page 349).
- F. Windshield washer fluid reservoir. See **Washer Fluid Check** (page 350).
- G. Engine coolant reservoir. See **Engine Coolant Check** (page 338).
- H. Power steering fluid reservoir. See **Power Steering Fluid Check** (page 350).
- I. Engine oil filler cap. See **Engine Oil Check** (page 333).
- J. Battery. See **Changing the 12V Battery** (page 353).

# Maintenance

## ENGINE OIL DIPSTICK - 6.2L/ 6.8L



E161560

- A MIN
- B MAX

## ENGINE OIL DIPSTICK - 6.7L DIESEL

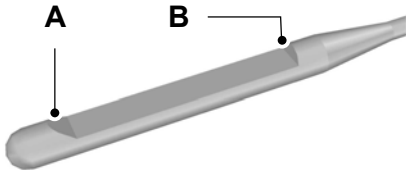

E71362

- A MIN
- B MAX

## ENGINE OIL CHECK - 6.2L/6.8L

To check the engine oil level consistently and accurately, do the following:

1. Make sure that your vehicle is on level ground.

2. Run engine until it reaches normal operating temperature.
3. Make sure the parking brake is on. Make sure the transmission is in park (P) or neutral (N).
4. Switch the engine off and wait 15 minutes for the oil to drain into the oil pan. Checking the engine oil level too soon after you switch the engine off may result in an inaccurate reading.
5. Open the hood. See **Opening and Closing the Hood** (page 328).
6. Remove the dipstick and wipe it with a clean, lint-free cloth. For 6.2L V8 See **Under Hood Overview** (page 329). For 6.8L Triton See **Under Hood Overview** (page 331).
7. Replace the dipstick and remove it again to check the oil level. See **Engine Oil Dipstick** (page 333).
8. Make sure that the oil level is between the maximum and minimum marks. If the oil level is at the minimum mark, add oil immediately. See **Capacities and Specifications** (page 420).
9. If the oil level is correct, replace the dipstick and make sure it is fully seated.

**Note:** Do not remove the dipstick when the engine is running.

**Note:** If the oil level is between the maximum and minimum marks, the oil level is acceptable. Do not add oil.

**Note:** The oil consumption of new engines reaches its normal level after approximately 3,000 mi (5,000 km).

## Adding Engine Oil

### WARNING



Do not remove the filler cap when the engine is running.



# Maintenance

Do not use supplemental engine oil additives because they are unnecessary and could lead to engine damage that may not be covered by the vehicle Warranty.



E142732

Only use oils certified for gasoline engines by the American Petroleum Institute (API). An oil with this trademark symbol conforms to the current engine and emission system protection standards and fuel economy requirements of the International Lubricants Specification Advisory Committee (ILSAC).

To top up the engine oil level do the following:

1. Clean the area surrounding the engine oil filler cap before you remove it.
2. Remove the engine oil filler cap. For 6.2L V8 See **Under Hood Overview** (page 329). For 6.8L Triton See **Under Hood Overview** (page 331).
3. Add engine oil that meets Ford specifications. See **Capacities and Specifications** (page 420).
4. Recheck the oil level.
5. If the oil level is correct, replace the dipstick and make sure it is fully seated.
6. Replace the engine oil filler cap. Turn it clockwise until you feel a strong resistance.

**Note:** Do not add oil further than the maximum mark. Oil levels above the maximum mark may cause engine damage.

**Note:** Make sure you install the oil filler cap correctly.

**Note:** Soak up any spillage with an absorbent cloth immediately.

## ENGINE OIL CHECK - 6.7L DIESEL

To check the engine oil level consistently and accurately, do the following:

1. Make sure the parking brake is on. Make sure the transmission is in park (P) or neutral (N).
2. Run engine until it reaches normal operating temperature.
3. Make sure that your vehicle is on level ground.
4. Switch the engine off and wait 15 minutes for the oil to drain into the oil pan. Checking the engine oil level too soon after you switch the engine off may result in an inaccurate reading.
5. Open the hood. See **Opening and Closing the Hood** (page 328).
6. Remove the dipstick and wipe it with a clean, lint-free cloth. See **Under Hood Overview** (page 330).
7. Replace the dipstick and remove it again to check the oil level. See **Engine Oil Dipstick** (page 333).
8. Make sure that the oil level is between the maximum and minimum marks. If the oil level is at the minimum mark, add oil immediately. See **Capacities and Specifications** (page 432).
9. If the oil level is correct, replace the dipstick and make sure it is fully seated.

**Note:** Do not remove the dipstick when the engine is running.

# Maintenance

**Note:** If the oil level is between the maximum and minimum marks, the oil level is acceptable. Do not add oil.

**Note:** The oil consumption of new engines reaches its normal level after approximately 3,000 mi (5,000 km).

## Adding Engine Oil

### WARNING



Do not remove the filler cap when the engine is running.

Do not use supplemental engine oil additives because they are unnecessary and could lead to engine damage that may not be covered by the vehicle Warranty.

To top up the engine oil level do the following:

1. Clean the area surrounding the engine oil filler cap before you remove it.
2. Remove the engine oil filler cap. See **Under Hood Overview** (page 330). Turn it counterclockwise and remove it.
3. Add engine oil of the proper viscosity and grade that meets Ford specifications. See **Capacities and Specifications** (page 432). You may have to use a funnel to pour the engine oil into the opening.
4. Recheck the oil level.
5. If the oil level is correct, replace the dipstick and make sure it is fully seated.
6. Replace the engine oil filler cap. Turn it clockwise until you feel a strong resistance.

**Note:** Do not add oil further than the maximum mark. Oil levels above the maximum mark may cause engine damage.

**Note:** Make sure you install the oil filler cap correctly.

**Note:** Soak up any spillage with an absorbent cloth immediately.

## Engine lubrication for severe service operation

The following conditions define severe operation for which engine operation with SAE 5W-40 oil which meets Ford specification, WSS-M2C171-F1, is recommended. Oil and oil filter change intervals will be determined by the Intelligent Oil Life Monitor™ as noted previously.

## CHANGING THE ENGINE OIL AND OIL FILTER

### WARNINGS



Do not handle a hot oil filter with bare hands.



Continuous contact with used motor oil has caused cancer in laboratory mice. Protect your skin by washing with soap and water.

If your vehicle is equipped with a diesel engine, an Intelligent Oil Life Monitor™ calculates the proper oil change service interval. When the information display indicates: OIL CHANGE REQUIRED, change the engine oil and oil filter. See **Information Displays** (page 113).

The engine oil filter protects your engine by filtering harmful, abrasive or sludge particles and particles significantly smaller than most available will-fit filters. See **Motorcraft Parts** (page 422).

1. Unscrew the oil filter and oil pan drain plug and wait for the oil to drain.
2. Replace the filter.
3. Reinstall the oil pan drain plug.

# Maintenance

4. Refill the engine with new oil. See **Capacities and Specifications** (page 432).
5. For diesel engines, you need to reset the Intelligent Oil Life Monitor™. See **Information Displays** (page 113).

## Engine lubrication for severe service operation

The following conditions define severe operation for which engine operation with SAE 5W-40 API CJ-4 is recommended. Oil and oil filter change intervals will be determined by the Intelligent Oil Life Monitor™ as noted previously.

- Frequent or extended idling (over 10 minutes per hour of normal driving).
- Low-speed operation/stationary use.
- If vehicle is operated in sustained ambient temperatures below -9°F (-23°C) or above 100°F (38°C).
- Frequent low-speed operation, consistent heavy traffic less than 25 mph (40 km/h).
- Operating in severe dust conditions.
- Operating the vehicle off road.
- Towing a trailer over 1,000 mi (1,600 km).
- Sustained, high-speed driving at Gross Vehicle Weight Rating (maximum loaded weight for vehicle operation).
- Use of fuels with sulfur content other than ultra-low sulfur diesel (ULSD).
- Use of high-sulfur diesel fuel.

## CHANGING THE CRANKCASE VENT FILTER ELEMENT (If

Equipped)

### WARNING



Do not dispose of engine oil or oil filters in the household refuse or the public sewage system. Use an authorized waste disposal facility.

Do not clean or recondition the filter element.

We recommend that you demand the use of genuine Ford and Motorcraft® parts whenever your vehicle requires scheduled maintenance or repair. Use the correct specification filter element. See **Capacities and Specifications** (page 432).

**Note:** *Operating your vehicle without a filter element or with an unapproved filter element may result in damage to the turbo charger or exchanger and could lead to engine damage that may not be covered by the vehicle Warranty.*

# Maintenance

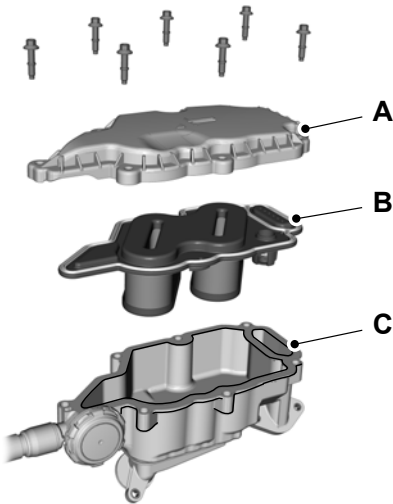

E211403

- A Filter cover.
- B Filter element.
- C Filter housing.

1. Clean the filter cover and remove the bolts.
2. Carefully remove the filter cover.
3. Remove used filter element from the filter housing and carefully dispose of it.
4. Make sure that the sealing surfaces on the filter housing and cover are clean and free of debris.
5. Install the new filter element.
6. Install the filter cover.
7. Install the bolts finger-tight.

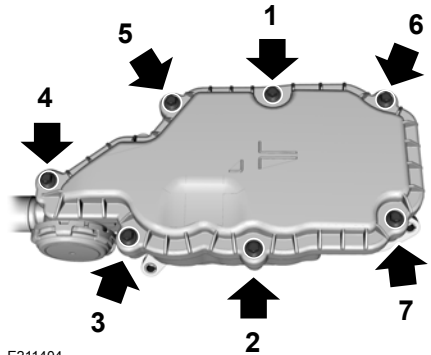

E211404

8. Fully tighten all of the bolts to between 3–4 lb.ft (4.5–6 Nm) in the sequence shown.
9. Record the engine mileage and update the service log accordingly.

## OIL CHANGE INDICATOR RESET

Use the information display controls on the steering wheel to reset the oil change indicator.

### From the main menu scroll to:

Message	Action and description
Settings	Press the right arrow button, then from this menu scroll to the following message.
Convenience	Press the right arrow button, then from this menu scroll to the following message.
Oil Life Reset	Press the right arrow button, then from this menu scroll to the following message.

# Maintenance

Message	Action and description
Hold OK to Reset	Press and hold the <b>OK</b> button until the instrument cluster displays the following message.  Reset Successful
	When the oil change indicator resets the instrument cluster displays 100%.  Remaining Life {00}%
	If the instrument cluster displays one of the following messages, repeat the process.  Not Reset  Reset Cancelled

When the engine is cold, check the concentration and level of the coolant at the intervals listed in the scheduled maintenance information. See **Scheduled Maintenance** (page 581).

**Note:** Make sure that the coolant level is between the **MIN** and the **MAX** marks on the coolant reservoir.

**Note:** Coolant expands when it is hot. The level may extend beyond the **MAX** mark.

Maintain coolant concentration within 48% to 50%, which equates to a freeze point between -30°F (-34°C) and -34°F (-37°C). Coolant concentration should be checked using a refractometer. We recommend, Robinair® Coolant and Battery Refractometer 75240 (Rotunda tool part number: ROB75240). We do not recommend the use of hydrometers or coolant test strips for measuring coolant concentration.

**Note:** Automotive fluids are not interchangeable. Do not use coolant or windshield washer fluid outside of its specified function and vehicle location.

**Note:** Do not use stop leak pellets, cooling system sealants, or non-specified additives as they can cause damage to the engine cooling or heating systems. Resulting component damage may not be covered by the vehicle Warranty.

## ENGINE COOLANT CHECK - 6.2L/6.8L

### WARNINGS



Never remove the coolant reservoir cap when the engine is running or hot.



Do not put coolant in the windshield washer reservoir. If sprayed on the windshield, coolant could make it difficult to see through the windshield.



To reduce the risk of personal injury, make sure the engine is cool before unscrewing the coolant pressure relief cap. The cooling system is under pressure. Steam and hot liquid can come out forcefully when you loosen the cap slightly.



Do not add coolant further than the **MAX** mark.

## Adding Coolant

### WARNING



Never remove the coolant reservoir cap when the engine is running or hot.

# Maintenance

---

It is very important to use prediluted coolant meeting the correct specification in order to avoid plugging the small passageways in the engine cooling system. See **Capacities and Specifications** (page 427). Incorrect prediluted coolant use can cause damage not covered by the vehicle Warranty.

If the coolant level is at or below the minimum mark, add prediluted coolant immediately.

To top up the coolant level do the following:

1. Unscrew the cap slowly. Any pressure escapes as you unscrew the cap.
2. Add prediluted coolant meeting the correct specification. See **Capacities and Specifications** (page 420).
3. Add enough prediluted coolant to reach the correct level.
4. Replace the coolant reservoir cap, turn it clockwise until you feel a strong resistance.
5. Check the coolant level in the coolant reservoir the next few times you drive your vehicle.

**Note:** *During normal vehicle operation, the coolant may change color from orange to pink or light red. As long as the coolant is clear and uncontaminated, this color change does not indicate the coolant has degraded nor does it require the coolant to be drained, the system to be flushed, or the coolant to be replaced.*

Do not mix different colors or types of prediluted coolant in your vehicle. Mixing of prediluted coolant or using an incorrect prediluted coolant may harm the engine or cooling system components and may not be covered by the vehicle Warranty.

In case of emergency, you can add a large amount of water without prediluted coolant in order to reach a vehicle service location. On arrival do the following:

1. Drain the cooling system.
2. Chemically clean the cooling system. We recommend Motorcraft Premium Cooling System Flush.
3. Refill with prediluted coolant as soon as possible.

Water alone, without prediluted coolant, can cause engine damage from corrosion, overheating or freezing.

Do not use the following as a coolant substitute:

- Alcohol.
- Methanol.
- Brine.
- Any coolant mixed with alcohol or methanol antifreeze.

Alcohol and other liquids can cause engine damage from overheating or freezing.

Do not add extra inhibitors or additives to the coolant. These can be harmful and compromise the corrosion protection of the coolant.

## Recycled Coolant

We do not recommend the use of recycled coolant as an approved recycling process is not yet available.

Dispose of used engine coolant in an appropriate manner. Follow your community's regulations and standards for recycling and disposing of automotive fluids.

# Maintenance

## Severe Climates

If you drive in extremely cold climates:

- It may be necessary to increase the coolant concentration above 50%.
- A coolant concentration of 60% provides improved freeze point protection. Coolant concentrations above 60% decrease the overheat protection characteristics of the coolant and may cause engine damage.

If you drive in extremely hot climates:

- It may be necessary to decrease the coolant concentration to 40%.
- A coolant concentration of 40% provides improved overheat protection. Coolant concentrations below 40% decrease the freeze and corrosion protection characteristics of the coolant and may cause engine damage.

Vehicles driven year-round in non-extreme climates should use prediluted coolant for optimum cooling system and engine protection.

## Fail-Safe Cooling

Fail-safe cooling allows you to temporarily drive your vehicle before any incremental component damage occurs. The fail-safe distance depends on ambient temperature, vehicle load and terrain.

### How Fail-Safe Cooling Works

If the engine begins to overheat, the coolant temperature gauge moves toward the red zone:



A warning lamp illuminates and a message may appear in the information display.



If the engine reaches a preset over-temperature condition, the engine automatically switches to alternating cylinder operation. Each disabled cylinder acts as an air pump and cools the engine.

When this occurs, your vehicle still operates, however:

- Engine power is limited.
- The air conditioning system turns off.

Continued operation increases the engine temperature, causing the engine to completely shut down. Your steering and braking effort increases in this situation.

When the engine temperature cools, you can re-start the engine. Have your vehicle checked as soon as possible to minimize engine damage.

## When Fail-Safe Mode Is Activated

### WARNINGS



Fail-safe mode is for use during emergencies only. Operate your vehicle in fail-safe mode only as long as necessary to bring your vehicle to rest in a safe location and seek immediate repairs. When in fail-safe mode, your vehicle will have limited power, will not be able to maintain high-speed operation, and may completely shut down without warning, potentially losing engine power, power steering assist, and power brake assist, which may increase the possibility of a crash resulting in serious injury.



Never remove the coolant reservoir cap when the engine is running or hot.

Your vehicle has limited engine power when in the fail-safe mode, drive your vehicle with caution. Your vehicle does not maintain high-speed operation and the engine may operate poorly.

# Maintenance

---

Remember that the engine is capable of automatically shutting down to prevent engine damage. In this situation:

1. Pull off the road as soon as safely possible and switch the engine off.
2. If you are a member of a roadside assistance program, we recommend that you contact your roadside assistance service provider.
3. If this is not possible, wait a short period for the engine to cool.
4. Check the coolant level. If the coolant level is at or below the minimum mark, add prediluted coolant immediately.
5. When the engine temperature cools, you can re-start the engine. Have your vehicle checked as soon as possible to minimize engine damage.

**Note:** *Driving your vehicle without repair increases the chance of engine damage.*

## Engine Coolant Temperature Management (If Equipped)

### WARNING



To reduce the risk of crash and injury, be prepared that the vehicle speed may reduce and the vehicle may not be able to accelerate with full power until the coolant temperature reduces.

---

If you tow a trailer with your vehicle, the engine may temporarily reach higher a temperature during severe operating conditions, for example ascending a long or steep grade in high ambient temperatures.

At this time, you may notice the coolant temperature gauge moves toward the red zone and a message may appear in the information display.

You may notice a reduction in vehicle speed caused by reduced engine power in order to manage the engine coolant temperature. Your vehicle may enter this mode if certain high-temperature and high-load conditions take place. The amount of speed reduction depends on vehicle loading, grade and ambient temperature. If this occurs, there is no need to pull off the road. You can continue to drive your vehicle.

The air conditioning may automatically turn on and off during severe operating conditions to protect the engine from overheating. When the coolant temperature decreases to the normal operating temperature, the air conditioning turns on.

If the coolant temperature gauge moves fully into the red zone, or if the coolant temperature warning or service engine soon messages appear in your information display, do the following:

1. Pull off the road as soon as safely possible and shift the transmission into park **(P)**.
2. Leave the engine running until the coolant temperature gauge needle returns to the normal position. After several minutes, if the temperature does not drop, follow the remaining steps.
3. Switch the engine off and wait for it to cool. Check the coolant level.
4. If the coolant level is at or below the minimum mark, add prediluted coolant immediately.
5. If the coolant level is normal, restart the engine and continue.



# Maintenance

## ENGINE COOLANT CHECK - 6.7L DIESEL

### WARNINGS



Never remove the coolant reservoir cap when the engine is running or hot.



Do not put coolant in the windshield washer reservoir. If sprayed on the windshield, coolant could make it difficult to see through the windshield.



To reduce the risk of personal injury, make sure the engine is cool before unscrewing the coolant pressure relief cap. The cooling system is under pressure. Steam and hot liquid can come out forcefully when you loosen the cap slightly.



Do not add coolant further than the **MAX** mark.

When the engine is cold, check the concentration and level of the coolant at the intervals listed in the scheduled maintenance information. See **Scheduled Maintenance** (page 581).

**Note:** Make sure that the coolant level is between the **MIN** and **MAX** marks on the coolant reservoir.

**Note:** Coolant expands when it is hot. The level may extend beyond the **MAX** mark.

Maintain coolant concentration within 48% to 50%, which equates to a freeze point between -30°F (-34°C) and -34°F (-37°C). Coolant concentration should be checked using a refractometer. We do not recommend the use of hydrometers or coolant test strips for measuring coolant concentration.

## Adding Coolant

### WARNINGS



Do not add engine coolant when the engine is hot. Failure to follow this instruction could result in personal injury.



Never remove the coolant reservoir cap when the engine is running or hot.

**Note:** Automotive fluids are not interchangeable. Do not use coolant or windshield washer fluid outside of its specified function and vehicle location.

**Note:** Do not use stop leak pellets, cooling system sealants, or non-specified additives as they can cause damage to the engine cooling or heating systems. Resulting component damage may not be covered by the vehicle Warranty.

It is very important to use prediluted coolant approved to the correct specification in order to avoid plugging the small passageways in the engine cooling system. See **Capacities and Specifications** (page 432). Do not mix different colors or types of coolant in your vehicle. Mixing of engine coolants or using an incorrect coolant may harm the engine or cooling system components and may not be covered by the vehicle Warranty.

**Note:** Coolants marketed for all makes and models may not be approved to Ford specifications and may cause damage to the cooling system. Resulting component damage may not be covered by the vehicle Warranty.

If the coolant level is at or below the minimum mark, add prediluted coolant immediately.

# Maintenance

---

For vehicles with overflow coolant systems with a non-pressurized cap on the coolant recovery system, add coolant to the coolant recovery reservoir when the engine is cool. Add prediluted coolant to the maximum level. For all vehicles which have a coolant degas system with a pressurized cap, or if it is necessary to remove the coolant pressure relief cap on the radiator, follow these steps to add engine coolant:

1. Turn the engine off and let it cool.
2. Unscrew the cap slowly. Any pressure escapes as you unscrew the cap.
3. Fill the coolant reservoir slowly with prediluted engine coolant to within the minimum and maximum range on the engine coolant reservoir. If you removed the radiator cap in an overflow system, fill the radiator until the coolant is visible and the radiator is almost full. If coolant is added to bring the level within the minimum and maximum range when the engine is not cold, the system may remain under filled.
4. Replace the coolant reservoir cap, turn it clockwise until you feel a strong resistance.
5. Check the coolant level in the coolant reservoir the next few times you drive your vehicle. If necessary, add enough prediluted engine coolant to bring the coolant level to the proper level.

**Note:** *If prediluted coolant is not available, use the approved antifreeze concentrate diluting it to 50/50 with distilled water. See **Capacities and Specifications** (page 432). Using water that has not been deionized may contribute to deposit formation, corrosion or plugging of the small cooling system passageways.*

If you have to add more than 1.1 qt (1 L) of engine coolant per month, have your vehicle checked as soon as possible. Operating an engine with a low level of coolant can result in engine overheating and possible engine damage.

**Note:** *During normal vehicle operation, the coolant may change color from orange to pink or light red. As long as the coolant is clear and uncontaminated, this color change does not indicate the coolant has degraded nor does it require the coolant to be drained, the system to be flushed, or the coolant to be replaced.*

**Note:** *In case of emergency, you can add a large amount of water without coolant in order to reach a vehicle service location. Water alone, without coolant, can cause engine damage from corrosion, overheating or freezing. When you reach a service location, you must have the cooling system drained, flushed and refilled using the correct specification prediluted coolant or antifreeze concentrate. See **Capacities and Specifications** (page 432).*

Do not use the following as a coolant substitute:

- Alcohol.
- Methanol.
- Brine.
- Any coolant mixed with alcohol or methanol antifreeze.

Alcohol and other liquids can cause engine damage from overheating or freezing.

Do not add extra inhibitors or non-specified additives to the coolant. These can be harmful and compromise the corrosion protection of the coolant.

# Maintenance

---

## Engine and Secondary Cooling System Refill Procedure

The following procedure should be used when refilling the engine or secondary cooling systems after it has been drained or become extremely low:

1. Before you remove the cap, turn the engine off and let it cool.
2. When the engine is cool, wrap a thick cloth around the cap. Slowly turn cap counterclockwise until pressure begins to release.
3. Step back while the pressure releases.
4. When you are sure that all the pressure has been released, use the cloth to turn it counterclockwise and remove the cap.
5. Slowly add prediluted engine coolant to the coolant reservoir until the coolant level is within the minimum and maximum range as listed on the reservoir.
6. Reinstall the pressure relief cap.
7. Start and run the engine at 2000 rpm for 2 minutes.
8. Shut engine off, and remove the pressure relief cap as previously outlined.
9. If required, add prediluted engine coolant to the coolant reservoir until the coolant level is within the minimum and maximum range as listed on the reservoir.
10. **Engine cooling system:** Repeat Step 5 until the coolant level has stabilized (is no longer dropping after each step) and the upper radiator hose at the radiator is warm to the touch (indicating that the engine thermostat is open and coolant is flowing through the radiator).

11. Check the secondary cooling system. Repeat Step 5 until the coolant level has stabilized (is no longer dropping after each step) and the lower passenger side of the secondary radiator is warm to the touch (indicating secondary thermostat is open and coolant is flowing through the entire system).
12. Reinstall the pressure relief cap. Shut the engine off and let it cool.
13. Check the coolant level in the reservoir before you drive your vehicle the next few times.
14. If necessary, add prediluted engine coolant to the coolant reservoir until the coolant level is within the minimum and maximum range as listed on the reservoir. After any coolant has been added, check the coolant concentration.

## Recycled Coolant

We do not recommend the use of recycled coolant as an approved recycling process is not yet available.

Dispose of used engine coolant in an appropriate manner. Follow your community's regulations and standards for recycling and disposing of automotive fluids.

## Severe Climates

If you drive in extremely cold climates:

- It may be necessary to increase the coolant concentration above 50%.
- A coolant concentration of 60% provides improved freeze point protection. Coolant concentrations above 60% decrease the overheat protection characteristics of the coolant and may cause engine damage.

# Maintenance

If you drive in extremely hot climates:

- You can decrease the coolant concentration to 40%.
- Coolant concentrations below 40% decrease the freeze and corrosion protection characteristics of the coolant and may cause engine damage.

Vehicles driven year-round in non-extreme climates should use prediluted engine coolant for optimum cooling system and engine protection.

## Checking Coolant Corrosion Inhibitor Additive Strength

At specific mileage intervals as listed in the scheduled maintenance information chapter, the coolant corrosion inhibitor additive should be checked. An information message may display in the optional information display at this time. The purpose of checking is to verify the correct engine coolant concentration (freeze point protection) and corrosion inhibitor additive level (strength) of the coolant for maximum engine performance and protection.

Three products are available to confirm the life and health of the coolant, one tool, a test kit and a coolant inhibitor additive:

- **Robinair® Coolant and Battery Refractometer 75240** – Recommended refractometer to test coolant concentration. (Rotunda tool part number: ROB75240).
- **Rotunda 328-R071–ELC (Antifreeze Coolant ELC Contamination Kit)** – Evaluates the corrosion inhibitor additive strength. Note the first step is to verify the vehicle's coolant concentration is in the correct range of 40 – 60%. Coolant concentrations outside this range will not provide valid test results. If the report results in a pass, for example the cooling system does not show excessive contamination, the corrosion inhibitor additive strength is sufficient, and no action is required. If the report results as insufficient (does not pass), the corrosion inhibitor additive strength of the coolant is too low. If the engine cooling system corrosion inhibitor additive strength is low, add 47 fl oz (1.4 L) of Motorcraft Specialty Orange Engine Coolant Revitalizer. If the secondary cooling system corrosion inhibitor additive strength is low, add 16 fl oz (0.47 L) of Motorcraft Specialty Orange Engine Coolant Revitalizer.
- **Motorcraft Specialty Orange Engine Coolant Revitalizer** – Additive to boost the corrosion inhibitor level based upon the test results of the Antifreeze Coolant ELC Contamination Kit. The Revitalizer may be added two times over the life of the coolant. If additional dosages are required, the cooling system must be flushed and refilled per the instructions in the Workshop Manual.

Make sure to follow the proper coolant and additive specifications. See **Capacities and Specifications** (page 420).

# Maintenance

---

## Coolant Change

At specific mileage intervals, as listed in the scheduled maintenance information, the coolant should be changed. The information display may display a message to change coolant at this time. Add prediluted coolant approved to the correct specification. See **Capacities and Specifications** (page 420).

## Engine-driven Cooling Fan (Fan Clutch)

Your vehicle may have an engine driven cooling fan drive (also called a fan clutch). This fan drive changes the fan speed to match the vehicle's changing cooling air flow requirements. Fan speed, fan noise level and fuel consumption all will increase based on the driving conditions that include trailer towing, hill climbing, heavy loads, high speed and high ambient temperature, individually or in combination.

The fan drive is designed to provide the minimum fan speed (and resulting minimum fan noise and fuel consumption) required to meet the ever changing vehicle cooling air flow requirements. You will hear the amount of fan noise increasing and decreasing as the engine power requirements and vehicle driving conditions change as you drive. This is to be expected as being normal to the operation of your vehicle. High levels of fan noise might also be heard when your engine is first started, and should normally decrease after driving for a short time.

## AUTOMATIC TRANSMISSION FLUID CHECK

Have an authorized dealer check and change the transmission fluid and filter at the correct service interval. See **Scheduled Maintenance** (page 581).

Do not use supplemental transmission fluid additives, treatments or cleaning agents. The use of these materials may affect transmission operation and result in damage to internal transmission components.

## Checking Automatic Transmission Fluid

For scheduled intervals of the fluid checks and changes, See **Scheduled Maintenance** (page 581). Your transmission does not consume fluid. However, the fluid level should be checked if the transmission is not working properly, i.e., if the transmission slips or shifts slowly or if you notice some sign of fluid leakage.

Automatic transmission fluid expands when warmed. To obtain an accurate fluid check, drive the vehicle until it is at normal operating temperature (approximately 19 mi (30 km)). Verify that the transmission fluid temperature gauge, located on the instrument cluster, is within normal range.

1. Drive the vehicle 19 mi (30 km) until it reaches normal operating temperature.
2. Park the vehicle on a level surface and engage the parking brake.
3. With the engine running, parking brake engaged and your foot on the brake pedal, move the gearshift lever through all of the gear ranges. Allow sufficient time for each gear to engage.
4. Latch the gearshift lever in **P** and leave the engine running.
5. Remove the dipstick, wiping it clean with a clean, dry lint free rag. If necessary, refer to the Under Hood Overview in this chapter for the location of the dipstick.

# Maintenance

6. Install the dipstick making sure it is fully seated in the filler tube.
7. Remove the dipstick and inspect the fluid level. The fluid should be in the designated area for normal operating temperature or ambient temperature.

## Low Fluid Level

Type A



E163739

Type B



E163740

Do not drive the vehicle if there is no indication of fluid on the dipstick and the ambient temperature is above 50°F (10°C).

## Correct Fluid Level

Type A

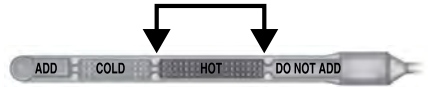

E163741

Type B



E163742

For vehicles equipped with 5-speed transmissions, check the fluid at the normal operating temperature of 151°F (66°C) to 170°F (77°C) on a level surface. For vehicles equipped with 6-speed transmissions, check the fluid at the normal operating temperature of 196°F (91°C) to 215°F (102°C) on a level surface. The normal operating temperature can be reached after approximately 19 mi (30 km).

## High Fluid Level

Type A

# Maintenance

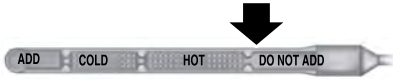

E163743

Type B



E163744

Fluid levels above the safe range may result in transmission failure. An overfill condition of transmission fluid may cause shift and engagement concerns, and possible damage.

High fluid levels can be caused by an overheating condition.

## Adjusting Automatic Transmission Fluid Levels

**Note:** Use of a non-approved automatic transmission fluid may cause internal transmission component damage.

Before adding any fluid, make sure the correct type is used. The type of fluid used is normally indicated on:

- the dipstick handle.
- See **Capacities and Specifications** (page 420).

If necessary, add fluid in 8 fl oz (250 ml) increments through the filler tube until the level is correct.

Type A

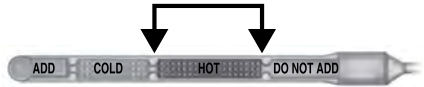

E163745

Type B



E163746

If an overfill occurs, excess fluid should be removed by a qualified technician.

**Note:** An overfill condition of transmission fluid may cause shift and engagement concerns, and possible damage.

# Maintenance

Do not use supplemental transmission fluid additives, treatments or cleaning agents. The use of these materials may affect transmission operation and result in damage to internal transmission components.

## TRANSFER CASE FLUID CHECK (If Equipped)

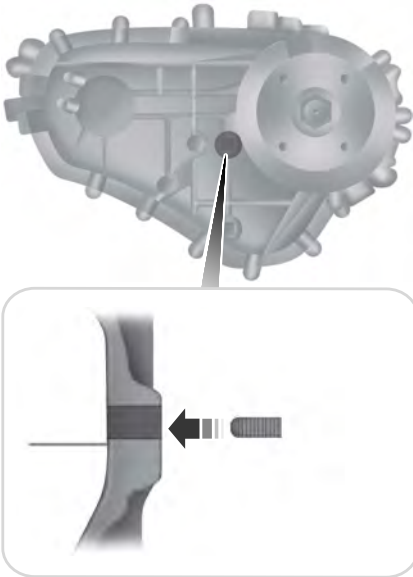





E164246

1. Clean the filler plug.
2. Remove the filler plug and inspect the fluid level.
3. Add only enough fluid through the filler opening so that the fluid level is at the bottom of the opening.

Only use fluid that meets Ford specifications. See **Capacities and Specifications** (page 420).

## BRAKE FLUID CHECK

### WARNINGS

-  Do not use any fluid other than the recommended brake fluid as this will reduce brake efficiency. Use of incorrect fluid could result in the loss of vehicle control, serious personal injury or death.
-  Only use brake fluid from a sealed container. Contamination with dirt, water, petroleum products or other materials may result in brake system damage or failure. Failure to adhere to this warning could result in the loss of vehicle control, serious personal injury or death.
-  Do not allow the fluid to touch your skin or eyes. If this happens, rinse the affected areas immediately with plenty of water and contact your physician.
-  A fluid level between the **MAX** and **MIN** lines is within the normal operating range and there is no need to add fluid. A fluid level not in the normal operating range could compromise the performance of the system. Have your vehicle checked immediately.



# Maintenance



E170684

To avoid fluid contamination, the reservoir cap must remain in place and fully tight, unless you are adding fluid.

Only use fluid that meets Ford specifications. See **Capacities and Specifications** (page 420).

## POWER STEERING FLUID CHECK

Check the power steering fluid. See **Scheduled Maintenance** (page 581). If adding fluid is necessary, use only MERCON LV ATF

Check the fluid level when it is at ambient temperature.

1. Check the fluid level in the reservoir. It should be between the MIN and MAX range. Do not add fluid if the level is within this range.
2. If the fluid level is low, add fluid to bring the fluid level up to between the MIN and MAX range.
3. Switch the engine on.

4. While the engine idles, turn the steering wheel left and right several times.
5. Switch the engine off.
6. Recheck the fluid level in the reservoir. Do not add fluid if the level is between the MIN and MAX range.
7. If the fluid is low, add fluid in small amounts, continuously checking the level until it is between the MIN and MAX range. For proper fluid type, See **Capacities and Specifications** (page 420). Be sure to put the cap back on the reservoir.

## WASHER FLUID CHECK

### WARNING



If you operate your vehicle in temperatures below 40°F (5°C), use washer fluid with antifreeze protection. Failure to use washer fluid with antifreeze protection in cold weather could result in impaired windshield vision and increase the risk of injury or accident.

Add fluid to fill the reservoir if the level is low. Only use a washer fluid that meets Ford specifications. See **Capacities and Specifications** (page 420).

State or local regulations on volatile organic compounds may restrict the use of methanol, a common windshield washer antifreeze additive. Washer fluids containing non-methanol antifreeze agents should be used only if they provide cold weather protection without damaging the vehicle's paint finish, wiper blades or washer system.

# Maintenance

## DRAINING THE FUEL FILTER WATER TRAP - 6.7L DIESEL

### WARNING



Do not dispose of fuel in the household refuse or the public sewage system. Use an authorized waste disposal facility.

Your vehicle has a diesel fuel conditioner module. The module is mounted between the outboard side of the fuel tank and the frame rail.

**Note:** *The module is at the front of the fuel tank or at the front of the aft-axle fuel tank on some models.*



You should drain water from the module assembly whenever the warning light illuminates or a message appears in the information display advising you to drain the water separator. This occurs when approximately 6.76 fl oz (200 ml) of water accumulates in the module. If you allow the water level to exceed this level, the water may pass through to the engine and may cause fuel injection equipment damage.

### Filter Location

Use the tables below to find the location of your filter.

#### Pick-up Truck

Cab Type	Box Length	Filter Location
Regular.	8 ft (2.4 m)	Left side of fuel tank.
SuperCab.	6.75 ft (2.057 m)	
	8 ft (2.4 m)	In front of fuel tank.
Super Crew Cab.	6.75 ft (2.057 m)	
	8 ft (2.4 m)	Left side of fuel tank.

#### Chassis Cab

Cab Type	Fuel Tank Type	Filter Location
Chassis Cab.	Single midship fuel tank	Right side of fuel tank.
Chassis Cab.	Aft axle/midship fuel tanks	Right side of midship fuel tank.
Chassis Cab.	Single aft axle fuel tank	Front of fuel tank.

## Draining the Diesel Fuel Conditioner Module

1. Switch the engine off.
2. Access the underside of your vehicle.

# Maintenance

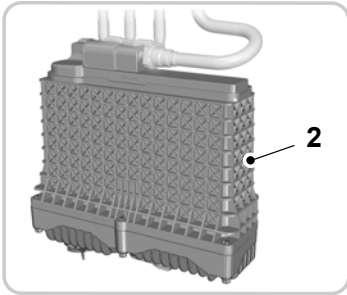
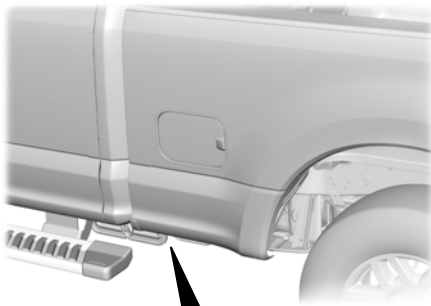

E226475

3. The diesel fuel conditioner module is on the left-hand frame rail.

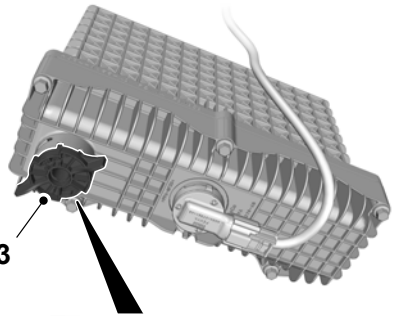

E226212

4. Drain the diesel fuel conditioner module. Turn the drain plug counterclockwise until it stops. Do not use any tools to loosen the drain plug. Drain the filter, approximately 0.5 gal (2 L), into an appropriate container. Do not re-use the fuel drained from the module.
5. Tighten the drain plug, turn it clockwise until it stops and you feel a strong resistance. Do not use any tools to tighten the drain plug.

## FUEL FILTER - 6.2L/6.8L

Your vehicle is equipped with a lifetime fuel filter that is integrated with the fuel tank. Regular maintenance or replacement is not needed.

# Maintenance

## CHANGING THE 12V BATTERY

### WARNINGS



Batteries normally produce explosive gases which can cause personal injury. Therefore, do not allow flames, sparks or lighted substances to come near the battery. When working near the battery, always shield your face and protect your eyes. Always provide correct ventilation.



When lifting a plastic-cased battery, excessive pressure on the end walls could cause acid to flow through the vent caps, resulting in personal injury and damage to the vehicle or battery. Lift the battery with a battery carrier or with your hands on opposite corners.



Keep batteries out of reach of children. Batteries contain sulfuric acid. Avoid contact with skin, eyes or clothing. Shield your eyes when working near the battery to protect against possible splashing of acid solution. In case of acid contact with skin or eyes, flush immediately with water for a minimum of 15 minutes and get prompt medical attention. If acid is swallowed, call a physician immediately.



Battery posts, terminals and related accessories contain lead and lead compounds. Wash hands after handling.



This vehicle may have more than one battery. Removing the battery cables from only one battery does not disconnect your vehicle electrical system. Make sure you disconnect the battery cables from all batteries when disconnecting power. Failure to do so may cause serious personal injury or property damage.

Your vehicle is fitted with a Motorcraft maintenance-free battery which normally does not require additional water.

When a battery replacement is required, you must use a recommended replacement battery that matches the electrical requirements of the vehicle.

**Note:** *After cleaning or replacing the battery, make sure you reinstall the battery cover or shield.*

**Note:** *If you add electrical accessories or components to the vehicle, it may adversely affect the low voltage battery performance and durability. This may also affect the performance of other electrical systems in the vehicle.*

For longer, trouble-free operation, keep the top of the battery clean and dry.

If you see any corrosion on the battery or terminals, remove the cables from the terminals and clean with a wire brush. You can neutralize the acid with a solution of baking soda and water.

Because your vehicle's engine is electronically controlled by a computer, some control conditions are maintained by power from the battery. When the battery is disconnected or a new battery is installed, the engine must relearn its idle and fuel trim strategy for optimum driveability and performance. Flexible fuel vehicles (FFV) must also relearn the ethanol content of the fuel for optimum driveability and performance.

To restore the settings, do the following:

1. Apply the parking brake.
2. Shift into park (P) or neutral (N).
3. Switch off all accessories.
4. Press the brake pedal and start your vehicle.

# Maintenance

5. Run the engine until it reaches normal operating temperature. While the engine is warming up, complete the following: Reset the clock. Reset the power windows bounce-back feature. See **Windows and Mirrors** (page 98). Reset the radio station presets. See **Audio System** (page 445).
6. Allow the engine to idle for at least one minute.
7. Drive the vehicle at least 10 mi (16 km) to completely relearn the idle trim and fuel trim strategy.

**Note:** *If you do not allow the engine to relearn the idle and fuel trim strategy, the idle quality of your vehicle may be adversely affected until the engine computer eventually relearns the idle trim and fuel trim strategy.*

**Note:** *For flexible fuel vehicles, if you are operating on E85, you may experience poor starts or an inability to start the engine and driveability problems until the fuel trim and ethanol content have been relearned.*

Make sure that you dispose of old batteries in an environmentally friendly way. Seek advice from your local authority about recycling old batteries.

If storing your vehicle for more than 30 days without recharging the battery, we recommend that you disconnect the battery cables to maintain battery charge for quick starting.

## **Battery Management System (if Equipped)**

The battery management system monitors battery conditions and takes actions to extend battery life. If excessive battery drain is detected, the system temporarily disables some electrical systems to protect the battery.

Systems included are:

- Heated rear window.
- Heated seats.
- Climate control.
- Heated steering wheel.
- Audio unit.
- Navigation system.

A message may appear in the information displays to alert you that battery protection actions are active. These messages are only for notification that an action is taking place, and not intended to indicate an electrical problem or that the battery requires replacement.

After battery replacement, or in some cases after charging the battery with an external charger, the battery management system requires eight hours of vehicle sleep time to relearn the battery state of charge. During this time your vehicle must remain fully locked with the ignition switched off.

**Note:** *Prior to relearning the battery state of charge, the battery management system may temporarily disable some electrical systems.*

## **Electrical Accessory Installation**

To make sure the battery management system works correctly, do not connect an electrical device ground connection directly to the battery negative post. This can cause inaccurate measurements of the battery condition and potential incorrect system operation.

**Note:** *If you add electrical accessories or components to the vehicle, it may adversely affect battery performance and durability. This may also affect the performance of other electrical systems in the vehicle.*

# Maintenance

## CHECKING THE WIPER BLADES



E142463

Run the tip of your fingers over the edge of the blade to check for roughness.

Clean the wiper blades with washer fluid or water applied with a soft sponge or cloth.

## CHANGING THE WIPER BLADES

You can manually move the wiper arms when the ignition is off. This allows for ease of blade replacement and cleaning under the blades.



E165804

1. Pull the wiper blade and arm away from the glass.



E165794

2. Release the wiper blade lock (A) and separate the wiper blade from the wiper arm.
3. Install in the reverse order.

**Note:** Make sure that the wiper blade locks into place. Lower the wiper arm and blade back on the windshield. The wiper arms will automatically return to their normal position when you turn the ignition on.

- Replace wiper blades at least once per year for optimum performance.
- You can improve poor wiper quality by cleaning the wiper blades and the windshield.

## ADJUSTING THE HEADLAMPS

### Vertical Aim Adjustment

The headlamps on your vehicle are properly aimed at the assembly plant. If your vehicle has been in an accident, the alignment of your headlamps should be checked by your authorized dealer.

# Maintenance

## Headlamp Aiming Target

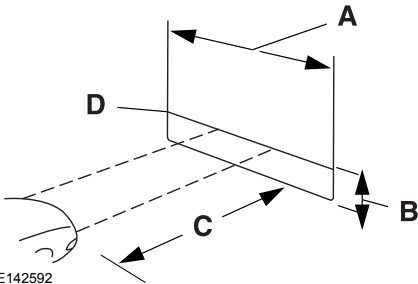

E142465

4. On the wall or screen you will observe a flat zone of high intensity light located at the top of the right hand portion of the beam pattern. If the top edge of the high intensity light zone is not at the horizontal reference line, the headlamp will need to be adjusted.

- A 8 feet (2.4 meters)
- B Center height of lamp to ground
- C 25 feet (7.6 meters)
- D Horizontal reference line

## Vertical Aim Adjustment Procedure

1. Park the vehicle directly in front of a wall or screen on a level surface, approximately 25 ft (7.6 m) away.
2. Measure the height of the headlamp bulb center from the ground and mark an 8 ft (2.4 m) horizontal reference line on the vertical wall or screen at this height.

**Note:** To see a clearer light pattern for adjusting, you may want to block the light from one headlamp while adjusting the other.

3. Turn on the low beam headlamps to illuminate the wall or screen and open the hood.

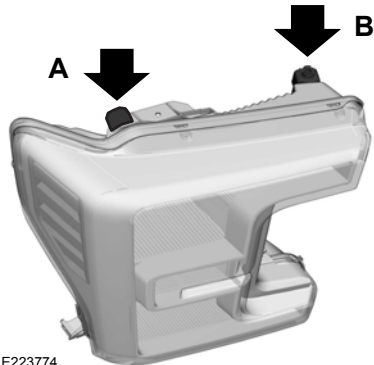

E223774

5. Locate the vertical adjuster on each headlamp. Using a Phillips #2 screwdriver, turn the adjuster either clockwise or counterclockwise in order to adjust the vertical aim of the headlamp.

**Note:** A. LED headlamp.  
B. Halogen headlamp.

# Maintenance

- Repeat steps 3 thru 5 to adjust the other headlamp.
- Close the hood and turn off the lamps.

## Horizontal Aim Adjustment

Horizontal aim is not required for this vehicle and is not adjustable.

## CHANGING A BULB

### WARNINGS



Switch the lamps and the ignition off. Failure to follow this warning could result in serious personal injury.



Bulbs become hot when in use. Let them cool down before you remove them.

Use the correct specification bulb. See **Bulb Specification Chart** (page 360). Install in the reverse order unless otherwise stated.

## Front Park and Direction Indicator Lamp Bulbs

**Note:** To access the right-hand side bulbs, remove the air intake pipe. See **Changing the Engine Air Filter** (page 362).

To access the left-hand side bulbs, remove the washer reservoir filler tube. Vehicles with diesel engine only.

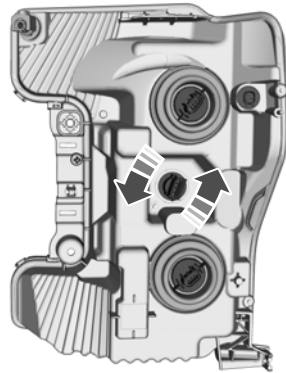

E224990

- Switch all of the lamps and the ignition off.
- Disconnect the electrical connector.
- Turn the bulb holder counterclockwise and remove it.

**Note:** You cannot separate the bulb from the bulb holder.

## Headlamp Bulbs

**Note:** To access the right-hand side bulbs, remove the air intake pipe. See **Changing the Engine Air Filter** (page 362).

To access the left-hand side bulbs, remove the washer reservoir filler tube. Vehicles with diesel engine only.



# Maintenance

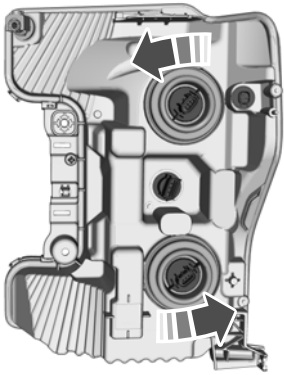

E224991

1. Switch all of the lamps and the ignition off.
2. Disconnect the electrical connector.
3. Turn the bulb holder counterclockwise and remove it.

**Note:** You cannot separate the bulb from the bulb holder.

**Note:** Handle a halogen headlamp bulb carefully and keep out of children's reach. Grasp the bulb only by its plastic base and do not touch the glass. The oil from your hand could cause the bulb to break the next time the headlamps are operated.

## Fog Lamp Bulbs (If Equipped)

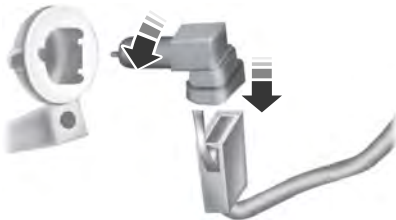

E163826

1. Switch all of the lamps and the ignition off.
2. To access the bulb, reach behind the bumper.
3. Disconnect the electrical connector.
4. Turn the bulb holder counterclockwise and remove it.

**Note:** You cannot separate the bulb from the bulb holder.

**Note:** Handle a halogen bulb carefully and keep out of children's reach. Grasp the bulb only by its plastic base and do not touch the glass. The oil from your hand could cause the bulb to break the next time the fog lamps are operated.

## Rear Lamps, Brake Lamps, Rear Direction Indicator and Reversing Lamp Bulbs

### Pickup Models - Vehicles without Blind Spot Information System

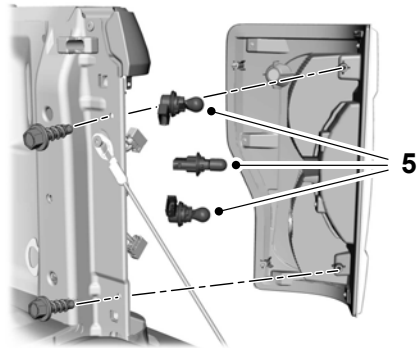

E223775

1. Switch all of the lamps and the ignition off.
2. Open the tailgate to expose the lamp assemblies.

# Maintenance

3. Remove the bolts from the tail lamp assembly and carefully pull the lamp assembly from the tailgate pillar by releasing the two retaining tabs.
4. Turn the bulb holder counterclockwise and remove it.
5. Remove the bulb by pulling it straight out.

## Pickup Models - Vehicles with Blind Spot Information System

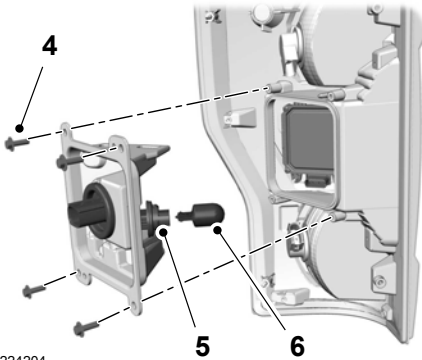

E224204

1. Switch all of the lamps and the ignition off.
2. Open the tailgate to expose the lamp assemblies.
3. Remove the bolts from the tail lamp assembly and carefully pull the lamp assembly from the tailgate pillar by releasing the two retaining tabs.
4. Remove the screws from the blind spot information system module cover.
5. Turn the bulb holder counterclockwise and remove it.
6. Remove the bulb by pulling it straight out.

## Chassis Cabs



E163828

1. Switch all of the lamps and the ignition off.
2. Remove the screws and the lamp lens from lamp assembly.
3. Remove the bulb by pulling it straight out.

## Cargo Lamp and Central High Mounted Brake Lamp Bulbs

1. Switch all of the lamps and the ignition off.
2. Remove the screws and carefully pull the lamp assembly from the vehicle to expose the bulb sockets.



E187290

3. Turn the bulb holder counterclockwise and remove it.

# Maintenance

- Remove the bulb by pulling it straight out.

## License Plate Lamp Bulb

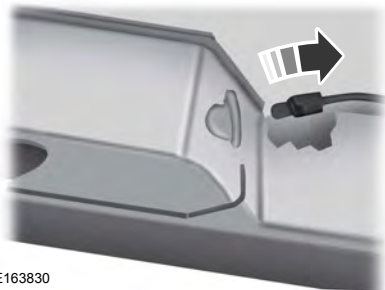

E163830

- Switch all of the lamps and the ignition off.

- To access the bulb, reach behind the bumper.
- Turn the bulb holder counterclockwise and remove it.
- Remove the bulb by pulling it straight out.

## BULB SPECIFICATION CHART

Replacement bulbs are specified in the chart below. Headlamp bulbs must be marked with an authorized D.O.T. marking for North America to make sure they have the proper lamp performance, light brightness, light pattern and safe visibility. The correct bulbs will not damage the lamp assembly or void the lamp assembly warranty and will provide quality bulb illumination time.

## Exterior Lamps

Lamp	Specification	Power (Watt)
Headlamps.	H13/9008	60/55
Front side marker lamps.	W5W	5
Front fog lamps.	9140	40
Front direction indicator and parking lamps.	T20/7444NA	28/8
Rear lamps, brake lamps, rear direction indicator and rear side marker lamps. Low series.*	3157	27/7
Rear lamps, brake lamps, rear direction indicator and rear side marker lamps. High series.*	LED	LED
Rear lamps, brake lamps, rear direction indicator and rear side marker lamps.**	3157	27/7
Reversing lamps.*	W21W	21
Reversing lamps.**	3157	27/7

# Maintenance

Lamp	Specification	Power (Watt)
License plate lamp. Low series.	168	5
License plate lamp. High series.	LED	LED
Central high mounted brake lamp.	912	12.8
Central high mounted cargo lamp.	912	12.8
Side direction indicator and mirror clearance lamp.	LED	LED
Front clearance lamp.	LED	LED
Rear clearance lamp.	LED	LED
Front identification lamp.	LED	LED
Rear identification lamp.	LED	LED
Underhood lamp.	LED	LED

\*Pickup only.

\*\*Chassis cab only.

**Note:** LED lamps are not serviceable. See an authorized dealer if they fail.

## Interior Lamps

Lamp	Specification	Power (Watt)
Map lamp.	LED	LED
Glove compartment lamp.	LED	LED
Interior lamp.	LED	LED
Overhead console lamp.	LED	LED
Luggage compartment lamp.	LED	LED

**Note:** LED lamps are not serviceable. See an authorized dealer if they fail.

# Maintenance

## CHANGING THE ENGINE AIR FILTER - 6.2L/6.8L

### WARNING



To reduce the risk of vehicle damage and personal burn injuries, do not start your engine with the air cleaner removed and do not remove it while the engine is running.

Use the correct specification air filter element. See **Motorcraft Parts** (page 422).

**Note:** Failure to use the correct air filter element may result in severe engine damage. Resulting component damage may not be covered by the vehicle Warranty.

Change the air filter element at the correct service interval. See **Scheduled Maintenance** (page 581).

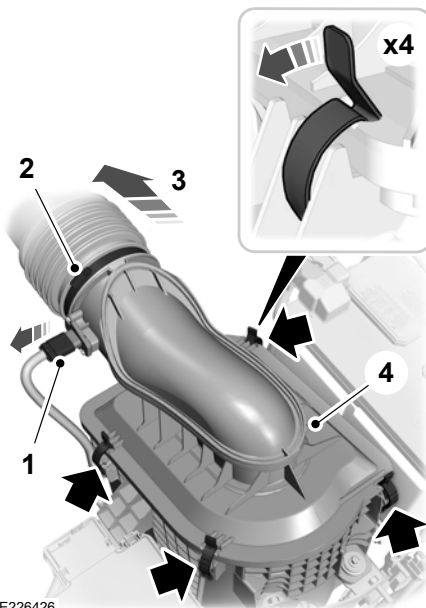

E226426

1. Disconnect the mass air flow sensor electrical connector. (6.8L only)
2. Remove the air intake tube securing clamp.
3. Pull the air intake tube away from the air filter housing.
4. Remove the clips that secure the air filter housing cover. Remove the air filter housing cover.

# Maintenance

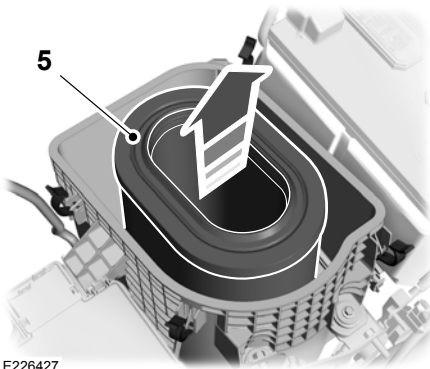

E226427

5. Remove the air filter element from the air filter housing.
6. Install in the reverse order.

## CHANGING THE ENGINE AIR FILTER - 6.7L DIESEL

### WARNING



To reduce the risk of vehicle damage and personal burn injuries, do not start your engine with the air cleaner removed and do not remove it while the engine is running.

Use the correct specification air filter element. See **Motorcraft Parts** (page 422).

**Note:** Failure to use the correct air filter element may result in severe engine damage. Resulting component damage may not be covered by the vehicle Warranty.

Change the air filter element at the correct service interval. See **Scheduled Maintenance** (page 581).

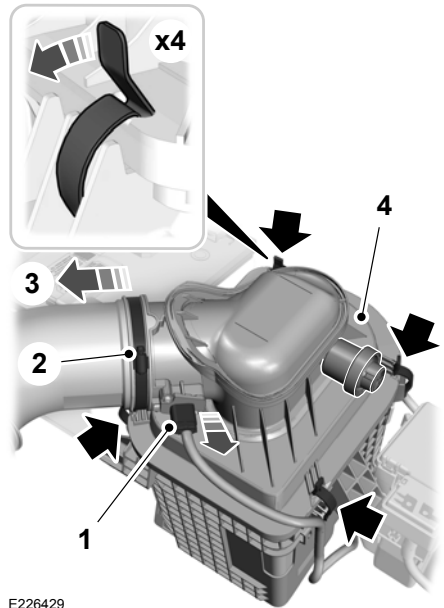

E226429

1. Disconnect the mass air flow sensor electrical connector.
2. Remove the air intake tube securing clamp.
3. Pull the air intake tube away from the air filter housing.
4. Remove the clips that secure the air filter housing cover. Remove the air filter housing cover.

# Maintenance

## Air Filter Restriction Gauge

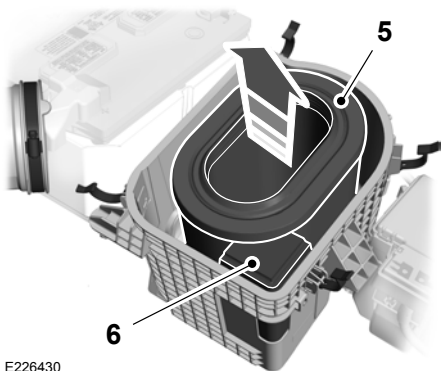

E226430

5. Remove the air filter element from the air filter housing.
6. Remove the foam filter from the air filter housing.
7. Install in the reverse order.

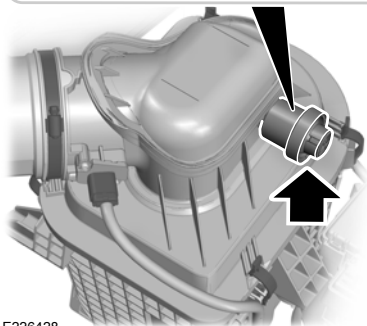

E226428

The air filter restriction gauge is in the upper housing of the air filter assembly.

Check the air filter restriction gauge whenever you open the hood to carry out general engine maintenance or at least every 7,500 mi (12,000 km). If you operate your vehicle in extremely dusty conditions, check the gauge at least every 500 mi (800 km) or two weeks, whichever occurs first. Change the air filter element when the restriction gauge reads near the **change filter** line and the gauge is yellow. Allowing the restriction gauge to reach maximum affects engine performance and fuel economy.

# Maintenance

Operating your vehicle in heavy snowfall or extreme rain conditions may allow excessive amounts of snow or water into the air intake system. This could restrict air flow and cause the engine to lose power or shut down.

After installing a new air filter element, you must reset the gauge by pressing the reset button.

After operating your vehicle during heavy snowfall or extreme rain, do the following:

- Snow: At the earliest opportunity, open the hood and clear any snow and ice from the air filter housing inlet and reset the air filter restriction gauge.
- Extreme rain: The air filter element dries out after approximately 15–30 minutes of driving at highway speeds. At the earliest opportunity, open the hood and reset the air filter restriction gauge.

**Note:** Do not remove the foam filter.

## CHANGING THE ENGINE-MOUNTED AND DIESEL FUEL CONDITIONER MODULE FUEL FILTERS - 6.7L DIESEL

### WARNING



Do not dispose of fuel in the household refuse or the public sewage system. Use an authorized waste disposal facility.

Your vehicle has two fuel filters. The first filter mounts on top of the engine on the left-hand side. The second filter is inside the diesel fuel conditioner module. The module is attached to the fuel tank in different locations depending on the configuration of your truck. See table below for configurations.

**Note:** *The module is at the front of the fuel tank or at the front of the aft-axle fuel tank on some models.*

Regular fuel filter changes are an important part of engine maintenance; failing to keep with the scheduled maintenance could lead to engine performance issues and fuel injection system damage. See **Scheduled Maintenance** (page 581).

Use only recommended service parts conforming to specifications. See **Motorcraft Parts** (page 422).

**Note:** *Using fuel that has high levels of impurities may require more frequent filter replacements than the service interval specifies.*

## Diesel Fuel Conditioner Module Filter

### Filter Location

Use the tables below to find the location of your filter.



# Maintenance

## Pick-up Truck

Cab Type	Box Length	Filter Location
Regular.	8 ft (2.4 m)	Left side of fuel tank.
SuperCab.	6.75 ft (2.057 m)	
	8 ft (2.4 m)	In front of fuel tank.
Super Crew Cab.	6.75 ft (2.057 m)	
	8 ft (2.4 m)	Left side of fuel tank.

## Chassis Cab

Cab Type	Fuel Tank Type	Filter Location
Chassis Cab.	Single midship fuel tank	Right side of fuel tank.
Chassis Cab.	Aft axle/midship fuel tanks	Right side of midship fuel tank.
Chassis Cab.	Single aft axle fuel tank	Front of fuel tank.

## Removal

2. Locate your filter.

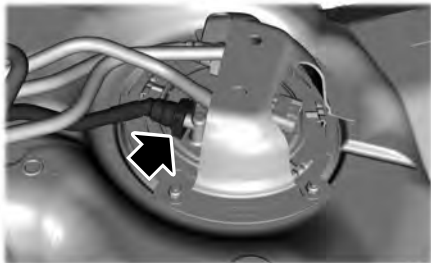

E247666

1. For 2017 models, disconnect the fuel line quick connect coupling from the in tank fuel pump. For 2018 models and later, skip this step but insure that the fuel filler cap is closed before draining the filter. If the cap isn't closed, the filter will siphon the fuel tank even with the anti-siphon valve.

# Maintenance

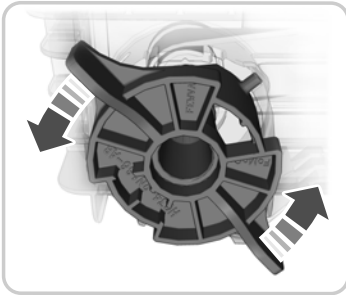
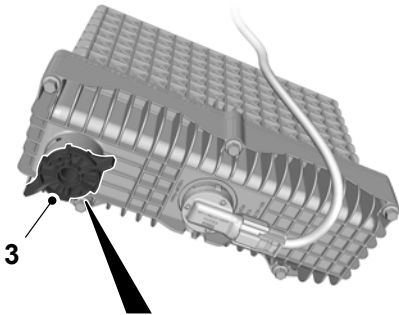

E226212

3. Drain the diesel fuel conditioner module. Turn the drain plug counterclockwise until it stops. Do not use any tools to loosen the drain plug. Drain the filter, approximately 0.53 gal (2 L), into an appropriate container. Do not re-use the fuel drained from the module.

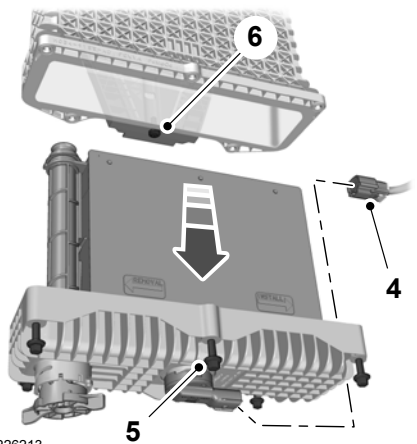

E226213

4. Disconnect the electrical connector.
5. Fully loosen the bolts securing the lower portion of the diesel fuel conditioner module housing.

**Note:** Do not fully remove the bolts from the lower portion of the diesel fuel conditioner module housing.

6. Remove the lower portion of the diesel fuel conditioner module housing.

# Maintenance

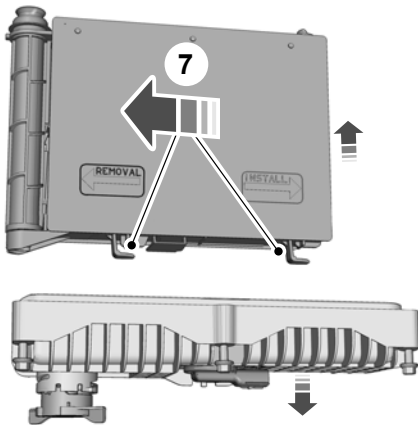

E226563

7. Slide the filter element toward the drain plug to disengage the securing clips.

## Installation

1. Slide the filter element into the housing and fully engage the securing clips.
2. Install the lower portion of the housing. Tighten the bolts until you feel a strong resistance. Maximum torque 7 lb.ft (9 Nm).
3. Connect the electrical connector.
4. Tighten the drain plug, turn it clockwise until it stops and you feel a strong resistance. Do not use any tools to tighten the drain plug.

## Engine-mounted Fuel Filter

Although the fuel system is not fully pressurized when the vehicle is off, some residual pressure may remain in the fuel system since it can take some time for the pressure to completely bleed off. Therefore, we recommend you place an absorbent cloth below the filter connectors to absorb any fuel that may drain.

The engine-mounted fuel filter is a plastic disposable cartridge.

## Removal

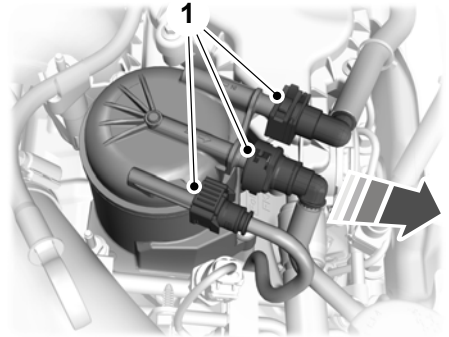

E226215

1. Disconnect the fuel lines by squeezing the connector tabs and pulling the lines straight off.

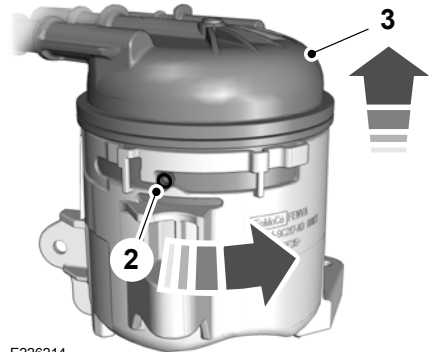

E226214

2. Rotate the filter fully counterclockwise until the peg is at the far end of the slot.
3. Pull the filter straight up from the bracket and discard the filter.

# Maintenance

---

## Installation

1. Install the new filter into the filter bracket. Turn the filter clockwise to lock it in place.
2. Reconnect the fuel lines.

# Vehicle Care

## GENERAL INFORMATION

Your dealer has many quality products available to clean your vehicle and protect its finishes.

## CLEANING PRODUCTS

### Materials

For best results, use the following products or products of equivalent quality:

Name	Specification
Motorcraft® Bug and Tar Remover, ZC-42 (U.S. & Canada)	
Motorcraft® Custom Bright Metal Cleaner, ZC-15 (U.S. & Canada)	ESR-M5B194-B
Motorcraft® Detail Wash, ZC-3-A (U.S. & Canada)	ESR-M14P4-A
Motorcraft® Engine Shampoo and Degreaser, ZC-20 (U.S.)	ESR-M14P3-A
Motorcraft® Engine Shampoo, CXC-66-A (Canada)	
Motorcraft® Premium Leather and Vinyl Cleaner, ZC-56 (U.S. & Canada)	WSS-M99P43-B
Motorcraft® Multi-Purpose Cleaner, CXC-101 (Canada)	
Motorcraft® Premium Windshield Wash Concentrate with Bitterant, ZC-32-B2 (U.S.)	WSS-M14P19-A
Motorcraft® Premium Quality Windshield Washer Fluid, CXC-37-A/B/D/F (Canada)	WSS-M14P19-A
Motorcraft® Professional Strength Carpet & Upholstery Cleaner, ZC-54 (U.S. & Canada)	
Motorcraft® Premium Glass Cleaner, CXC-100 (Canada)	ESR-M14P5-A
Motorcraft® Spot and Stain Remover, ZC-14 (U.S.)	
Motorcraft® Ultra-Clear Spray Glass Cleaner, ZC-23 (U.S.)	ESR-M14P5-A
Motorcraft® Wheel and Tire Cleaner, ZC-37-A (U.S. & Canada)	

## CLEANING THE EXTERIOR

Wash your vehicle regularly with cool or lukewarm water and a neutral pH shampoo, we recommend Motorcraft Detail Wash.

- Never use strong household detergents or soap, for example dish washing or laundry liquid. These products can discolor and spot painted surfaces.
- Never wash your vehicle when it is hot to the touch, or during strong or direct sunlight.

# Vehicle Care

---

- Dry your vehicle with a chamois or soft terry cloth towel to eliminate water spotting.
- Immediately remove fuel spillages, bird droppings, insect deposits and road tar. These may cause damage to your vehicle's paintwork or trim over time. We recommend Motorcraft Bug and Tar Remover.
- Remove any exterior accessories, for example antennas, before entering a car wash.

**Note:** *Suntan lotions and insect repellents can damage painted surfaces. If these substances come in contact with your vehicle, wash the affected area as soon as possible.*

## Cleaning the Headlamps

**Note:** *Do not scrape the headlamp lenses or use abrasives, alcoholic solvents or chemical solvents to clean them.*

**Note:** *Do not wipe the headlamps when they are dry.*

## Exterior Chrome Parts

- Apply a high quality-cleaning product to bumpers and other chrome parts. Follow the manufacturer's instructions. We recommend Motorcraft Custom Bright Metal Cleaner.
- Do not apply the cleaning product to hot surfaces. Do not leave the cleaning product on chrome surfaces longer than the time recommended.
- Using non-recommended cleaners can result in severe and permanent cosmetic damage.

**Note:** *Never use abrasive materials, for example steel wool or plastic pads as they can scratch the chrome surface.*

**Note:** *Do not use chrome cleaner, metal cleaner or polish on wheels or wheel covers.*

## Exterior Plastic Parts

For routine cleaning we recommend Motorcraft Detail Wash. If tar or grease spots are present, we recommend Motorcraft Bug and Tar Remover.

## Stripes or Graphics (If Equipped)

Hand washing your vehicle is preferred however, pressure washing may be used under the following conditions:

- Do not use water pressure higher than 2,000 psi (14,000 kPa).
- Do not use water hotter than 179°F (82°C).
- Use a spray with a 40° wide spray angle pattern.
- Keep the nozzle at a 12 in (305 mm) distance and 90° angle to your vehicle's surface.

**Note:** *Holding the pressure washer nozzle at an angle to the vehicle's surface may damage graphics and cause the edges to peel away from the vehicle's surface.*

## Underbody

Regularly clean the underside of your vehicle using water. Keep body and door drain holes free of debris or foreign material.

## Under Hood

For removing black rubber marks from under the hood we recommend Motorcraft Wheel and Tire Cleaner or Motorcraft Bug and Tar Remover.

## WAXING

Regular waxing is necessary to protect your car's paint from the elements. We recommend that you wash and wax the painted surface once or twice a year.

# Vehicle Care

When washing and waxing, park your vehicle in a shaded area out of direct sunlight. Always wash your vehicle before applying wax.

- Use a quality wax that does not contain abrasives.
- Follow the manufacturer's instructions to apply and remove the wax.
- Apply a small amount of wax in a back-and-forth motion, not in circles.
- Do not allow wax to come in contact with any non-body (low-gloss black) colored trim. The wax will discolor or stain the parts over time.
  - Roof racks.
  - Bumpers.
  - Grained door handles.
  - Side moldings.
  - Mirror housings.
  - Windshield cowl area.
- Do not apply wax to glass areas.
- After waxing, your car's paint should feel smooth, and be free of streaks and smudges.

## CLEANING THE ENGINE

Engines are more efficient when they are clean because grease and dirt buildup keep the engine warmer than normal.

When washing:

- Take care when using a power washer to clean the engine. The high-pressure fluid could penetrate the sealed parts and cause damage.
  - Do not spray a hot engine with cold water to avoid cracking the engine block or other engine components.
- Spray Motorcraft Engine Shampoo and Degreaser on all parts that require cleaning and pressure rinse clean. In Canada, use Motorcraft Engine Shampoo.
  - Never wash or rinse the engine while it is hot or running; water in the running engine may cause internal damage.
  - Never wash or rinse any ignition coil, spark plug wire or spark plug well, or the area in and around these locations.
  - Cover the battery, power distribution box, and air filter assembly to prevent water damage when cleaning the engine.

## CLEANING THE EXHAUST - 6.7L DIESEL

### WARNINGS



Failure to maintain the functional holes, in the tailpipe section of the exhaust, clean and free of debris or foreign material may result in the holes becoming blocked or plugged. Do not modify or remove the tail-pipe section. Blocked or plugged holes or removal/modification of the system could result in elevated exhaust gas temperatures which may result in vehicle/property damage or personal injury.



The normal operating temperature of the exhaust system is very high. Never work around or attempt to repair any part of the exhaust system until it has cooled. Use special care when working around the diesel oxidation catalytic converter and/or the diesel particulate filter (DPF). The diesel

# Vehicle Care

## WARNINGS

oxidation catalytic converter and/or the DPF heats up to a high temperature after only a short period of engine operation and can stay hot even after the engine is turned off. Failure to follow these instructions may result in personal injury.

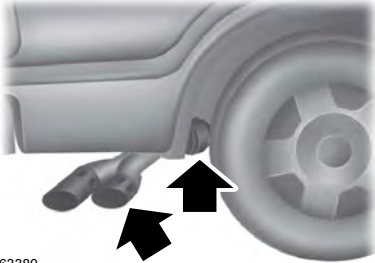

E163380

The visible holes in the exhaust tip and the holes under the shield just inboard of the right rear tire(s) are functional. The holes need to be kept clear of mud/debris or foreign material to maintain proper function of the exhaust system. Clean and remove debris or foreign material if present as needed. Spraying with a hose during regular washing of vehicle should help keep holes clean and clear of debris or foreign material.

## CLEANING THE WINDOWS AND WIPER BLADES

Car wash chemicals and environmental fallout can result in windshield and wiper blade contamination. Dirty windshield and wipers will result in poor windshield wiper operation. Keep the windshield and wiper blades clean to maintain windshield wiper performance.

To clean the windshield and wiper blades:

- Clean the windshield with a non-abrasive glass cleaner. When cleaning the interior of the windshield, avoid getting any glass cleaner on the instrument panel or door panels. Wipe any glass cleaner off these surfaces immediately.
- For windshields contaminated with tree sap, chemicals, wax or bugs, clean the entire windshield using steel wool (no greater than 0000 grade) in a circular motion and rinse with water.
- Clean the wiper blades with isopropyl rubbing alcohol or windshield washer concentrate.

**Note:** Do not use razor blades or other sharp objects to clean or remove decals from the inside of the heated rear window. The vehicle warranty does not cover damage caused to the heated rear window grid lines.

## CLEANING THE INTERIOR

### WARNINGS

 Do not use cleaning solvents, bleach or dye on the vehicle's seatbelts, as these actions may weaken the belt webbing.

 On vehicles equipped with seat-mounted airbags, do not use chemical solvents or strong detergents. Such products could contaminate the side airbag system and affect performance of the side airbag in a crash.



## Vehicle Care

For fabric, carpets, cloth seats and seats equipped with side airbags:

- Remove dust and loose dirt with a vacuum cleaner.
- Remove light stains and soil with Motorcraft Professional Strength Carpet & Upholstery Cleaner.
- If grease or tar is present on the material, spot-clean the area first with Motorcraft Spot and Stain Remover. In Canada, use Motorcraft Multi-Purpose Cleaner.
- If a ring forms on the fabric after spot cleaning, clean the entire area immediately (but do not oversaturate) or the ring will set.
- Do not use household cleaning products or glass cleaners, which can stain and discolor the fabric and affect the flame retardant abilities of the seat materials.

**Note:** Microfiber cloth fabric is made of polyester microfiber with micro-porous polyurethane. Using commercially available fabric cleaners can cause permanent damage.

**Note:** Do not use commercially available leather and vinyl cleaning products on microfiber cloth fabric.

**Note:** Your vehicle may have microfiber cloth fabric on the seats, headliner, floor mats and door panels.

Depending on the type of stain, use water, lemon juice or pure ethyl alcohol when cleaning. For cleaning microfiber cloth, refer to the following chart:

Type of Stain	Cleaning Procedure
Fruit juice, jam, jelly, syrup or ketchup.	Use lukewarm water and rinse by dabbing with clean water.
Blood, egg, excrement or urine.	Use cold water and rinse by dabbing with clean water. Avoid warm water because it makes these substances coagulate.
Liquor, alcoholic beverages, wine, beer, cola and tea.	Use lukewarm water. If the color remains, treat with lemon juice and then rinse.
Indelible pencil, cocoa, chocolate, pastry with cream or chocolate, ice cream or mustard.	Use lukewarm water and rinse by dabbing with clean water.
Vinegar, hair gel, tomato sauce or coffee with sugar.	Use lemon juice, wipe with lukewarm water and rinse by dabbing with clean water.
Dye transfer and all other stains.	Use ethyl alcohol, then dab with water.

# Vehicle Care

## CLEANING THE INSTRUMENT PANEL AND INSTRUMENT CLUSTER LENS

### WARNING



Do not use chemical solvents or strong detergents when cleaning the steering wheel or instrument panel to avoid contamination of the airbag system.

**Note:** Follow the same procedure as cleaning leather seats for cleaning leather instrument panels and leather interior trim surfaces. See **Cleaning Leather Seats** (page 375).

Clean the instrument panel and cluster lens with a clean, damp and soft cloth, then use a clean, dry and soft cloth to dry these areas.

- Avoid cleaners or polishes that increase the gloss of the upper portion of the instrument panel. The dull finish in this area helps protect you from undesirable windshield reflection.
- Do not use any household cleaning products or glass cleaners as these may damage the finish of the instrument panel, interior trim and cluster lens.
- Wash or wipe your hands clean if you have been in contact with certain products such as insect repellent and suntan lotion to avoid possible damage to the interior painted surfaces.
- Do not allow air fresheners and hand sanitizers to spill onto interior surfaces. If a spill occurs, wipe off immediately. Your warranty may not cover these damages.

If a staining liquid like coffee or juice has been spilled on the instrument panel or on interior trim surfaces:

1. Wipe up spilled liquid using a clean, soft cloth as quickly as possible.
2. Use Motorcraft Premium Leather and Vinyl Cleaner or a commercially available leather cleaning product for automotive interiors. Test any cleaner or stain remover on an inconspicuous area.
3. Alternatively, wipe the surface with a clean, soft cloth and a mild soap and water solution. Dry the area with a clean, soft cloth.
4. If necessary, apply more soap and water solution or cleaning product to a clean, soft cloth and press it onto the soiled area. Allow this to set at room temperature for 30 minutes.
5. Remove the soaked cloth, then with a clean, damp cloth, use a rubbing motion for 60 seconds on the soiled area.
6. Dry the area with a clean, soft cloth.

## CLEANING LEATHER SEATS (if

Equipped)

### Without King Ranch Edition

**Note:** Follow the same procedure as cleaning leather seats for cleaning leather instrument panels and leather interior trim surfaces.

For routine cleaning, wipe the surface with a soft, damp cloth and a mild soap and water solution. Dry the area with a clean, soft cloth.

For cleaning and removing spots and stains such as dye transfer, use Motorcraft Premium Leather and Vinyl Cleaner or a commercially available leather cleaning product for automotive interiors.

**Note:** Test any cleaner or stain remover on an inconspicuous area.

# Vehicle Care

---

You should:

- Remove dust and loose dirt with a vacuum cleaner.
- Clean and treat spills and stains as soon as possible.

Do not use the following products as these may damage the leather:

- Oil and petroleum or silicone-based leather conditioners.
- Household cleaners.
- Alcohol solutions.
- Solvents or cleaners intended specifically for rubber, vinyl and plastics.

## With King Ranch Edition

Your vehicle has seating covered in premium, top-grain leather that is extremely durable, but still requires special care and maintenance in order to preserve longevity and comfort.

Regular cleaning and conditioning maintains the appearance of the leather.

### Cleaning

For dirt, use a vacuum cleaner then use a clean, damp cloth or soft brush.

For routine cleaning, wipe the surface with a soft, damp cloth. For more thorough cleaning, wipe the surface with a mild soap and water solution.

- Clean spills as quickly as possible.
- Test any cleaner or stain remover on an inconspicuous part of the leather as cleaners may darken the leather.

- Do not spill coffee, ketchup, mustard, orange juice or oil-based products on the leather as they may permanently stain the leather.
- Do not use household cleaning products, alcohol solutions, solvents or cleaners intended for rubber, vinyl or plastics.

### Scratches

Because the leather in the seat comes from genuine steer hides, there may be evidence of naturally occurring markings, such as small scars. These markings give character to the seating covers and are considered to be proof of a genuine leather product.

In order to lessen the appearance of certain scratches and other wear marks, apply conditioner on the affected area following the same instructions as in the **Conditioning** section.

### Conditioning

Bottles of King Ranch Leather Conditioner are available at the King Ranch Saddle Shop. Visit the website at [www.krsaddleshop.com](http://www.krsaddleshop.com), or call 1-800-282-KING (5464) in the United States. If you are unable to obtain King Ranch Leather Conditioner, use another premium leather conditioner.

- Clean the surfaces using the steps outlined in the Cleaning section.
- Make sure the leather is dry then apply a nickel-sized amount of conditioner to a clean, dry cloth.
- Rub the conditioner into the leather until it disappears. Allow the conditioner to dry, then repeat the process for the entire interior. If a film appears, wipe it off with a dry, clean cloth.

# Vehicle Care

## REPAIRING MINOR PAINT DAMAGE

Authorized dealers have touch-up paint to match your vehicle's color. Your vehicle color code is printed on a sticker on the front, left-hand side door jamb. Take your color code to your authorized dealer to make sure you get the correct color.

Before repairing minor paint damage, use a cleaner such as Motorcraft Bug and Tar Remover to remove particles such as bird droppings, tree sap, insect deposits, tar spots, road salt and industrial fallout.

Always read the instructions before using cleaning products.

## CLEANING THE WHEELS (If

### Equipped)

1. Regularly clean them with a wheel cleaner. We recommend that you use Ford approved wheel cleaner if available.
2. Remove dirt and brake dust with a sponge.
3. Remove tar and grease with a bug and tar remover. We recommend that you use Ford approved bug and tar remover if available.
4. Thoroughly rinse the wheels with water after cleaning.

If you intend on parking your vehicle for an extended period after cleaning the wheels with a wheel cleaner, drive your vehicle for a few minutes before doing so. This reduces the risk of corrosion of the brake discs, brake pads and linings.

Do not clean the wheels when they are hot.

**Note:** *Some car washes could damage wheel rims and covers.*

**Note:** *Using non-recommended cleaners, harsh cleaning products, chrome wheel cleaners or abrasive materials could damage wheel rims and covers.*

## VEHICLE STORAGE

If you plan on storing your vehicle for 30 days or more, read the following maintenance recommendations to make sure your vehicle stays in good operating condition.

We engineer and test all motor vehicles and their components for reliable, regular driving. Under various conditions, long-term storage may lead to degraded engine performance or failure unless you use specific precautions to preserve engine components.

### General

- Store all vehicles in a dry, ventilated place.
- Protect from sunlight, if possible.
- If vehicles are stored outside, they require regular maintenance to protect against rust and damage.

### Body

- Wash your vehicle thoroughly to remove dirt, grease, oil, tar or mud from exterior surfaces, rear-wheel housing and the underside of front fenders.
- Periodically wash your vehicle if it is stored in exposed locations.
- Touch-up exposed or primed metal to prevent rust.
- Cover chrome and stainless steel parts with a thick coat of auto wax to prevent discoloration. Re-wax as necessary when you wash your vehicle.
- Lubricate all hood, door and luggage compartment hinges and latches with a light grade oil.

# Vehicle Care

---

- Cover interior trim to prevent fading.
- Keep all rubber parts free from oil and solvents.

## Engine

- Change the engine oil and filter prior to storage because used engine oil contains contaminants which may cause engine damage.
- Start the engine every 15 days for a minimum of 15 minutes. Run at fast idle with the climate controls set to defrost until the engine reaches normal operating temperature.
- With your foot on the brake, shift through all the gears while the engine is running.
- We recommend that you change the engine oil before you use your vehicle again.

## Fuel system

- Fill the fuel tank with high-quality fuel until the first automatic shutoff of the fuel pump nozzle.

## Cooling system

- Protect against freezing temperatures.
- When removing your vehicle from storage, check coolant fluid level. Confirm that there are no cooling system leaks and that fluid is at the recommended level.

## Battery

- Check and recharge as necessary. Keep connections clean.
- If storing your vehicle for more than 30 days without recharging the battery, we recommend that you disconnect the battery cables to maintain battery charge for quick starting.

**Note:** *It is necessary to reset memory features if battery cables are disconnected.*

## Brakes

- Make sure the brakes and parking brake release fully.

## Tires

- Maintain recommended air pressure.

## Miscellaneous

- Make sure all linkages, cables, levers and pins under your vehicle are covered with grease to prevent rust.
- Move vehicles at least 25 ft (7.5 m) every 15 days to lubricate working parts and prevent corrosion.

## Removing Vehicle From Storage

When your vehicle is ready to come out of storage, do the following:

- Wash your vehicle to remove any dirt or grease film build-up on window surfaces.
- Check windshield wipers for any deterioration.
- Check under the hood for any foreign material that may have collected during storage such as mice or squirrel nests.
- Check the exhaust for any foreign material that may have collected during storage.
- Check tire pressures and set tire inflation per the Tire Label.
- Check brake pedal operation. Drive your vehicle 15 ft (4.5 m) back and forth to remove rust build-up.

## Vehicle Care

---

- Check fluid levels (including coolant, oil and gas) to make sure there are no leaks, and fluids are at recommended levels.
- If you remove the battery, clean the battery cable ends and check for damage.

Contact an authorized dealer if you have any concerns or issues.

# Wheels and Tires

## GENERAL INFORMATION

Use only approved wheel and tire sizes, using other sizes could damage your vehicle. If you change the diameter of the tires from that fitted at the factory, the speedometer may not display the correct speed. Take your vehicle to an authorized dealer to have the system reprogrammed. If you intend to change the size of the wheels from that fitted by the manufacturer, you can check the suitability with an authorized dealer.

Additional information related to the functionality and maintenance of your tires can be found later in this chapter. See **Tire Care** (page 382).

The Ford recommended tire inflation pressures can be found on the Tire Label, which is located on the B-pillar or the edge of the driver's door. This information can also be found on the Safety Compliance Certification Label (affixed to either the door hinge pillar, door-latch post, or the door edge that meets the door last post; next to the driver's seating position).

Ford strongly recommends maintaining these tire pressures at all times. Failure to follow the tire pressure recommendations can cause uneven treadwear patterns, reduced fuel economy, and adversely affect the way your vehicle handles.





**Note:** Check and set the tire pressure at the ambient temperature in which you are intending to drive your vehicle and when the tires are cold.

**Note:** Check your tire pressures at least once per month.

Set the pressure for your spare tire to the highest value given for your vehicle and tire size combination (if equipped).

## Notice to utility vehicle and truck owners

### WARNINGS

-  Utility vehicles have a significantly higher rollover rate than other types of vehicles.
-  Vehicles with a higher center of gravity (utility and four-wheel drive vehicles) handle differently than vehicles with a lower center of gravity (passenger cars). Avoid sharp turns, excessive speed and abrupt steering in these vehicles. Failure to drive cautiously increases the risk of losing control of your vehicle, vehicle rollover, personal injury and death.
-  In a rollover crash, an unbelted person is significantly more likely to die than a person wearing a seatbelt.
-  Do not become overconfident in the ability of four-wheel drive vehicles. Although a four-wheel drive vehicle may accelerate better than a two-wheel drive vehicle in low traction situations, it won't stop any faster than two-wheel drive vehicles. Always drive at a safe speed.



E145298

# Wheels and Tires

Utility vehicles and trucks handle differently than passenger cars in the various driving conditions that are encountered on streets, highways and off-road. Utility vehicles and trucks are not designed for cornering at speeds as high as passenger cars any more than low-slung sports cars are designed to perform satisfactorily under off-road conditions.

Study your owner's manual and any supplements for specific information about equipment features, instructions for safe driving and additional precautions to reduce the risk of an accident or serious injury.

## Four-wheel drive system (If Equipped)

### WARNING



Do not become overconfident in the ability of four-wheel drive vehicles.

Although a four-wheel drive vehicle may accelerate better than a two-wheel drive vehicle in low traction situations, it won't stop any faster than two-wheel drive vehicles. Always drive at a safe speed.

A vehicle equipped with four-wheel drive, when selected, has the ability to use all four wheels to power itself. This increases traction which may enable you to safely drive over terrain and road conditions that a conventional two-wheel drive vehicle cannot.

Power is supplied to all four wheels through a transfer case or power transfer unit. Four-wheel drive vehicles allow you to select different modes as necessary. For information on transfer case operation and shifting procedures, See **Four-Wheel Drive** (page 214). For information on transfer case maintenance, See **Maintenance** (page 328). You should become thoroughly familiar with this information before you operate your vehicle.

On some four-wheel drive vehicles, the initial shift from two-wheel to four-wheel drive when the vehicle is moving can cause a momentary clunk and ratcheting sound. These sounds are normal and are not cause for concern.

In four-wheel drive vehicles, the size of the spare tire relative to the remaining tires can have an effect on the 4x4 system. If there is a significant difference between the size of a spare and the remaining tires, four-wheel drive functionality may be limited. See **Using Four-Wheel Drive** (page 214).

## How your vehicle differs from other vehicles

Sport utility vehicles and trucks can differ from some other vehicles in a few noticeable ways. Your vehicle may be:

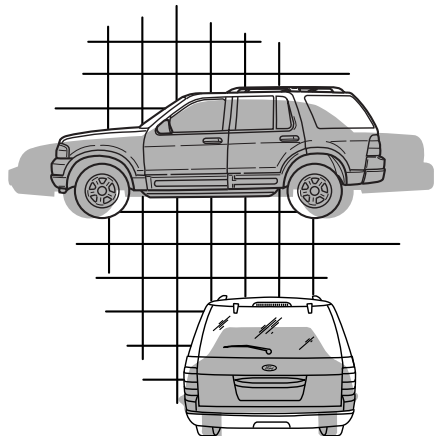

E145299



# Wheels and Tires

- Higher - to allow higher load carrying capacity and to allow it to travel over rough terrain without getting hung up or damaging underbody components.
- Shorter - to give it the capability to approach inclines and drive over the crest of a hill without getting hung up or damaging underbody components. All other things held equal, a shorter wheelbase may make your vehicle quicker to respond to steering inputs than a vehicle with a longer wheelbase.
- Narrower - to provide greater maneuverability in tight spaces, particularly in off-road use.

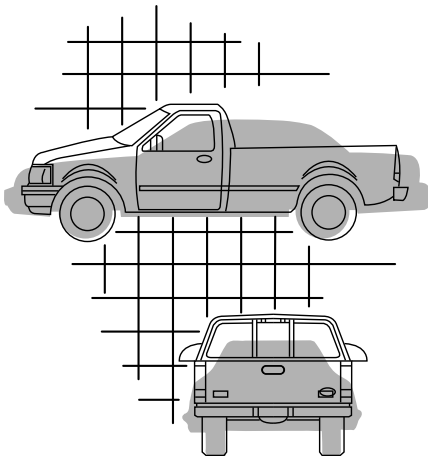

E168583

As a result of the above dimensional differences, Sport utility vehicles and trucks often have a higher center of gravity and a greater difference in center of gravity between the loaded and unloaded condition. These differences that make your vehicle so versatile also make it handle differently than an ordinary passenger car.

## TIRE CARE

### Information About Uniform Tire Quality Grading



E142542

Tire Quality Grades apply to new pneumatic passenger car tires. The Quality grades can be found where applicable on the tire sidewall between tread shoulder and maximum section width. For example: **Treadwear 200**  
**Traction AA** **Temperature A.**

These Tire Quality Grades are determined by standards that the United States Department of Transportation has set.

# Wheels and Tires

---

Tire Quality Grades apply to new pneumatic passenger car tires. They do not apply to deep tread, winter-type snow tires, space-saver or temporary use spare tires, light truck or LT type tires, tires with nominal rim diameters of 10 to 12 inches or limited production tires as defined in Title 49 Code of Federal Regulations Part 575.104 ©)(2).

## U.S. Department of Transportation Tire quality grades:

The U.S. Department of Transportation requires Ford Motor Company to give you the following information about tire grades exactly as the government has written it.

### Treadwear

The treadwear grade is a comparative rating based on the wear rate of the tire when tested under controlled conditions on a specified government test course. For example, a tire graded 150 would wear one and one-half (1 ½) times as well on the government course as a tire graded 100. The relative performance of tires depends upon the actual conditions of their use, however, and may depart significantly from the norm due to variations in driving habits, service practices, and differences in road characteristics and climate.

### Traction AA A B C

#### WARNING



The traction grade assigned to this tire is based on straight-ahead braking traction tests, and does not include acceleration, cornering, hydroplaning or peak traction characteristics.

---

The traction grades, from highest to lowest are AA, A, B, and C. The grades represent the tire's ability to stop on wet pavement as measured under controlled conditions on specified government test surfaces of asphalt and concrete. A tire marked C may have poor traction performance.

### Temperature A B C

#### WARNING



The temperature grade for this tire is established for a tire that is properly inflated and not overloaded. Excessive speed, underinflation, or excessive loading, either separately or in combination, can cause heat buildup and possible tire failure.

---

The temperature grades are A (the highest), B and C, representing the tire's resistance to the generation of heat and its ability to dissipate heat when tested under controlled conditions on a specified indoor laboratory

# Wheels and Tires

---

test wheel. Sustained high temperature can cause the material of the tire to degenerate and reduce tire life, and excessive temperature can lead to sudden tire failure. The grade C corresponds to a level of performance which all passenger car tires must meet under the Federal Motor Vehicle Safety Standard No. 139. Grades B and A represent higher levels of performance on the laboratory test wheel than the minimum required by law.

## Glossary of Tire Terminology

\***Tire label:** A label showing the original equipment tire sizes, recommended inflation pressure and the maximum weight the vehicle can carry.

\***Tire Identification Number (TIN):** A number on the sidewall of each tire providing information about the tire brand and manufacturing plant, tire size and date of manufacture. Also referred to as DOT code.

\***Inflation pressure:** A measure of the amount of air in a tire.

\***Standard load:** A class of P-metric or Metric tires designed to carry a maximum load at set pressure. For example: For P-metric tires 35 psi (2.4 bar) and for Metric tires 36 psi (2.5 bar). Increasing the inflation pressure beyond this pressure will not increase the tire's load carrying capability.

\***Extra load:** A class of P-metric or Metric tires designed to carry a heavier maximum load at 42 psi (2.9 bar). Increasing the inflation pressure beyond this pressure will not increase the tire's load carrying capability.

\***kPa:** Kilopascal, a metric unit of air pressure.

\***PSI:** Pounds per square inch, a standard unit of air pressure.

\***Cold tire pressure:** The tire pressure when the vehicle has been stationary and out of direct sunlight for an hour or more and prior to the vehicle being driven for 1 mile (1.6 kilometers).

\***Recommended inflation pressure:** The cold inflation pressure found on the Safety Compliance Certification Label (affixed to either the door hinge pillar, door-latch post, or the door edge that meets the door-latch post, next to the driver's seating position), or Tire Label located on the B-pillar or the edge of the driver's door.

# Wheels and Tires

**B-pillar:** The structural member at the side of the vehicle behind the front door.

\***Bead area of the tire:** Area of the tire next to the rim.

\***Sidewall of the tire:** Area between the bead area and the tread.

\***Tread area of the tire:** Area of the perimeter of the tire that contacts the road when mounted on the vehicle.

\***Rim:** The metal support (wheel) for a tire or a tire and tube assembly upon which the tire beads are seated.

## Information Contained on the Tire Sidewall

Both United States and Canada Federal regulations require tire manufacturers to place standardized information on the sidewall of all tires. This information identifies and describes the fundamental characteristics of the tire and also provides a U.S. DOT Tire Identification Number for safety standard certification and in case of a recall.

## Information on P Type Tires

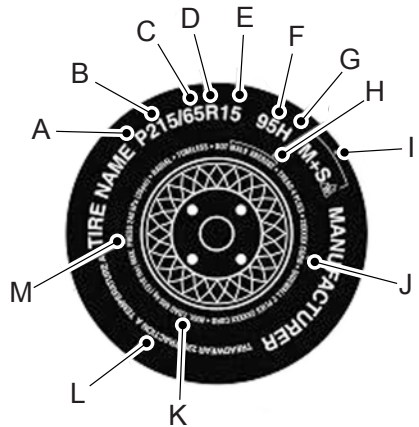

E142543

P215/65R15 95H is an example of a tire size, load index and speed rating. The definitions of these items are listed below. (Note that the tire size, load index and speed rating for your vehicle may be different from this example).

A. **P:** Indicates a tire, designated by the Tire and Rim Association, that may be used for service on cars, sport utility vehicles, minivans and light trucks. **Note:** If your tire size does not begin with a letter this may mean it is designated by either the European Tire and Rim Technical Organization or the Japan Tire Manufacturing Association.

# Wheels and Tires

B. **215:** Indicates the nominal width of the tire in millimeters from sidewall edge to sidewall edge. In general, the larger the number, the wider the tire.

C. **65:** Indicates the aspect ratio which gives the tire's ratio of height to width.

D. **R:** Indicates a radial type tire.

E. **15:** Indicates the wheel or rim diameter in inches. If you change your wheel size, you will have to purchase new tires to match the new wheel diameter.

F. **95:** Indicates the tire's load index. It is an index that relates to how much weight a tire can carry. You may find this information in your owner's manual. If not, contact a local tire dealer.

**Note:** *You may not find this information on all tires because it is not required by federal law.*

G. **H:** Indicates the tire's speed rating. The speed rating denotes the speed at which a tire is designed to be driven for extended periods of time under a standard condition of load and inflation pressure. The tires on your vehicle may operate at different conditions for load and inflation pressure. These speed ratings may need to be adjusted for the difference in conditions. The ratings range from 81 mph (130 km/h) to 186 mph (299 km/h). These ratings are listed in the following chart.

**Note:** *You may not find this information on all tires because it is not required by federal law.*

Letter rating	mph ( km/h)
M	81 (130)
N	87 (140)
Q	99 (159)
R	106 (171)
S	112 (180)
T	118 (190)
U	124 (200)
H	130 (210)
V	149 (240)
W	168 (270)
Y	186 (299)

**Note:** *For tires with a maximum speed capability over 149 mph (240 km/h), tire manufacturers sometimes use the letters ZR. For those with a maximum speed capability over 186 mph (299 km/h), tire manufacturers always use the letters ZR.*

H. **U.S. DOT Tire Identification Number:** This begins with the letters DOT and indicates that the tire meets all federal standards. The next two numbers or letters are the plant code designating where it was manufactured, the next two are the tire size code and

# Wheels and Tires

---

the last four numbers represent the week and year the tire was built. For example, the numbers 317 mean the 31st week of 1997. After 2000 the numbers go to four digits. For example, 2501 means the 25th week of 2001. The numbers in between are identification codes used for traceability. This information is used to contact customers if a tire defect requires a recall.

I. **M+S or M/S:** Mud and Snow, or

**AT:** All Terrain, or

**AS:** All Season.

## J. Tire Ply Composition and Material Used:

Indicates the number of plies or the number of layers of rubber-coated fabric in the tire tread and sidewall. Tire manufacturers also must indicate the ply materials in the tire and the sidewall, which include steel, nylon, polyester, and others.

K. **Maximum Load:** Indicates the maximum load in kilograms and pounds that can be carried by the tire. (affixed to either the door hinge pillar, door-latch post, or the door edge that meets the door-latch post, next to the driver's seating position), or Tire Label located on the B-pillar or the edge of the driver's door.

## L. Treadwear, Traction and Temperature Grades:

\***Treadwear** The treadwear grade is a comparative rating based on the wear rate of the tire when tested under controlled conditions on a specified government test course. For example, a tire graded 150 would wear 1½ times as well on the government course as a tire graded 100.

\***Traction:** The traction grades, from highest to lowest are AA, A, B, and C. The grades represent the tire's ability to stop on wet pavement as measured under controlled conditions on specified government test surfaces of asphalt and concrete. A tire marked C may have poor traction performance.

\***Temperature:** The temperature grades are A (the highest), B and C, representing the tire's resistance to the generation of heat and its ability to dissipate heat when tested under controlled conditions on a specified indoor laboratory test wheel.

## M. Maximum Inflation

**Pressure:** Indicates the tire manufacturers' maximum permissible pressure or the pressure at which the maximum load can be carried by the tire. This pressure is normally higher than the vehicle manufacturer's recommended cold inflation pressure which can be found on the Safety Compliance Certification Label (affixed to either the door hinge pillar, door-latch post, or the door edge

# Wheels and Tires

that meets the door-latch post, next to the driver's seating position), or Tire Label located on the B-pillar or the edge of the driver's door. The cold inflation pressure should never be set lower than the recommended pressure on the vehicle label.

The tire suppliers may have additional markings, notes or warnings such as standard load or radial tubeless.

## Additional Information Contained on the Tire Sidewall for LT Type Tires

**Note:** *Tire Quality Grades do not apply to this type of tire.*

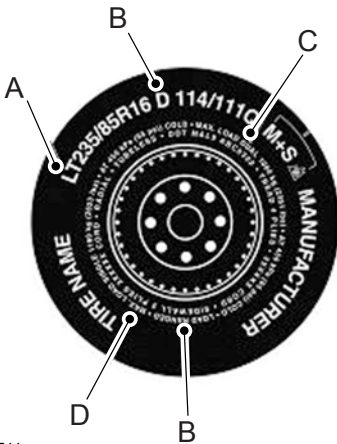

E142544

LT type tires have some additional information beyond those of P type tires. These differences are described below.

A. **LT:** Indicates a tire, designated by the Tire and Rim Association, that is intended for service on light trucks.

B. **Load Range and Load Inflation Limits:** Indicates the tire's load-carrying capabilities and its inflation limits.

C. **Maximum Load Dual lb (kg) at psi (kPa) cold:** Indicates the maximum load and tire pressure when the tire is used as a dual; defined as four tires on the rear axle (a total of six or more tires on the vehicle).

D. **Maximum Load Single lb (kg) at psi (kPa) cold:** Indicates the maximum load and tire pressure when the tire is used as a single; defined as two tires (total) on the rear axle.

## Information on T Type Tires

T145/80D16 is an example of a tire size.

**Note:** *The temporary tire size for your vehicle may be different from this example. Tire Quality Grades do not apply to this type of tire.*

# Wheels and Tires

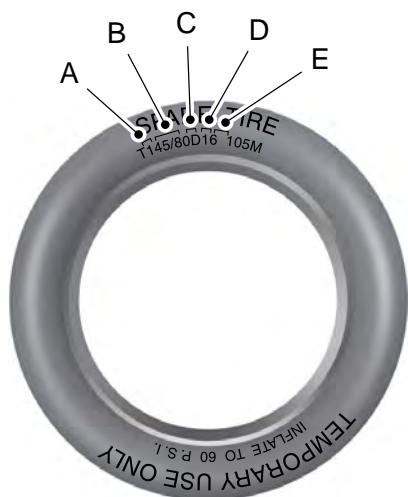

E142545

T type tires have some additional information beyond those of P type tires. These differences are described below:

**A. T:** Indicates a type of tire, designated by the Tire and Rim Association, that is intended for temporary service on cars, sport utility vehicles, minivans and light trucks.

**B. 145:** Indicates the nominal width of the tire in millimeters from sidewall edge to sidewall edge. In general, the larger the number, the wider the tire.

**C. 80:** Indicates the aspect ratio which gives the tire's ratio of height to width. Numbers of 70 or lower indicate a short sidewall.

**D. D:** Indicates a diagonal type tire.

**R:** Indicates a radial type tire.

**E. 16:** Indicates the wheel or rim diameter in inches. If you change your wheel size, you will have to purchase new tires to match the new wheel diameter.

## Location of the Tire Label

You will find a Tire Label containing tire inflation pressure by tire size and other important information located on the B-Pillar or the edge of the driver's door.

## Inflating Your Tires

Safe operation of your vehicle requires that your tires are properly inflated. Remember that a tire can lose up to half of its air pressure without appearing flat.

Every day before you drive, check your tires. If one looks lower than the others, use a tire gauge to check pressure of all tires and adjust if required.

At least once a month and before long trips, inspect each tire and check the tire pressure with a tire gauge (including spare, if equipped). Inflate all tires to the inflation pressure recommended by Ford Motor Company.



## Wheels and Tires

---

You are strongly urged to buy a reliable tire pressure gauge, as automatic service station gauges may be inaccurate. Ford recommends the use of a digital or dial-type tire pressure gauge rather than a stick-type tire pressure gauge.

Use the recommended cold inflation pressure for optimum tire performance and wear. Under-inflation or over-inflation may cause uneven treadwear patterns.

### WARNING



Under-inflation is the most common cause of tire failures and may result in severe tire cracking, tread separation or blowout, with unexpected loss of vehicle control and increased risk of injury. Under-inflation increases sidewall flexing and rolling resistance, resulting in heat buildup and internal damage to the tire. It also may result in unnecessary tire stress, irregular wear, loss of vehicle control and accidents. A tire can lose up to half of its air pressure and not appear to be flat!

Always inflate your tires to the Ford recommended inflation pressure even if it is less than the maximum inflation pressure information found on the tire. The Ford recommended tire inflation pressure is found on the Safety Compliance Certification Label or

Tire Label (affixed to either the door hinge pillar, door-latch post, or the door edge that meets the door-latch post, next to the driver's seating position), or Tire Label located on the B-pillar or the edge of the driver's door. Failure to follow the tire pressure recommendations can cause uneven treadwear patterns and adversely affect the way your vehicle handles.

**Note:** *Do not reduce tire pressure to change the ride characteristics of the vehicle. If you do not maintain the inflation pressure at the levels specified by Ford, your vehicle may experience a condition known as shimmy. Shimmy is a severe vibration and oscillation in the steering wheel after the vehicle travels over a bump or dip in the road that does not dampen out by itself. Shimmy may result from significant under-inflation of the tires, improper tires (load range, size, or type), or vehicle modifications such as lift-kits. In the event that your vehicle experiences shimmy, you should slowly reduce speed by either lifting off the accelerator pedal or lightly applying the brakes. The shimmy will cease as the vehicle speed decreases.*

**Maximum Inflation Pressure** is the tire manufacturer's maximum permissible pressure and the pressure at which the maximum load can be carried by the tire. This pressure is normally higher than

# Wheels and Tires

---

the manufacturer's recommended cold inflation pressure which can be found on the Safety Compliance Certification Label (affixed to either the door hinge pillar, door-latch post, or the door edge that meets the door-latch post, next to the driver's seating position), or Tire Label located on the B-pillar or the edge of the driver's door. The cold inflation pressure should never be set lower than the recommended pressure on the Safety Compliance Certification Label or Tire Label.

When weather temperature changes occur, tire inflation pressures also change. A 10°F (6°C) temperature drop can cause a corresponding drop of 1 psi (7 kPa) in inflation pressure. Check your tire pressures frequently and adjust them to the proper pressure which can be found on the Safety Compliance Certification Label or Tire Label.

To check the pressure in your tire(s):

1. Make sure the tires are cool, meaning they are not hot from driving even a mile.

**Note:** *If you are checking tire pressure when the tire is hot, (for example, driven more than 1 mile [1.6 kilometers]), never bleed or reduce air pressure. The tires are hot from driving and it is normal for pressures to increase above recommended cold pressures. A hot tire at or below recommended cold inflation pressure could be significantly under-inflated.*

**Note:** *If you have to drive a distance to get air for your tire(s), check and record the tire pressure first and add the appropriate air pressure when you get to the pump. It is normal for tires to heat up and the air pressure inside to go up as you drive.*

2. Remove the cap from the valve on one tire, then firmly press the tire gauge onto the valve and measure the pressure.

3. Add enough air to reach the recommended air pressure.

**Note:** *If you overfill the tire, release air by pressing on the metal stem in the center of the valve. Then recheck the pressure with your tire gauge.*

4. Replace the valve cap.

5. Repeat this procedure for each tire, including the spare.

# Wheels and Tires

---

**Note:** *Some spare tires operate at a higher inflation pressure than the other tires. For T type mini-spare tires, (see the Dissimilar spare wheel and tire assembly information for a description. Store and maintain at 60 psi (4.15 bar). For full-size and dissimilar spare tires, see the Dissimilar spare wheel and tire assembly information for a description. Store and maintain at the higher of the front and rear inflation pressure as shown on the Safety Compliance Certification Label or Tire Label.*

6. Visually inspect the tires to make sure there are no nails or other objects embedded that could poke a hole in the tire and cause an air leak.

7. Check the sidewalls to make sure there are no gouges, cuts or bulges.

## Tire Inflation Information

### WARNING

 An inflated tire and rim can be very dangerous if improperly used, serviced or maintained. To reduce the risk of serious injury, never attempt to re-inflate a tire which has been run flat or seriously under-inflated without first removing the tire from the wheel assembly for inspection. Do not attempt to add air to tires or replace tires or wheels without first taking precautions to protect persons and property.

---

All tires with Steel Carcass Plies (if equipped):

This type of tire utilizes steel cords in the sidewalls. As such, they cannot be treated like normal light truck tires. Tire service, including adjusting tire pressure, must be performed by personnel trained, supervised and equipped according to Federal Occupational Safety and Health Administration regulations. For example, during any procedure involving tire inflation, the technician or individual must utilize a remote inflation device, and ensure that all persons are clear of the trajectory area.

### WARNING

 Always inflate steel carcass tires with a remote air fill with the person inflating standing at a minimum of 12 ft (3.66 m) away from the wheel and tire assembly.

---

# Wheels and Tires

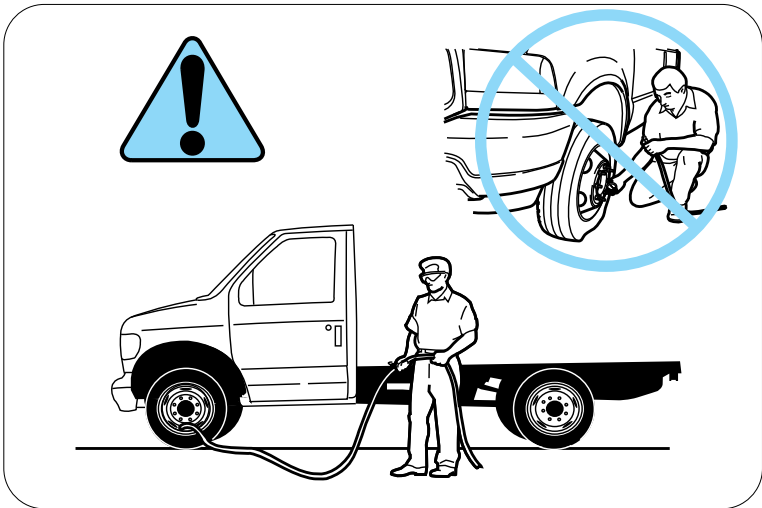

E161437

## Inspecting Your Tires and Wheel Valve Stems

Periodically inspect the tire treads for uneven or excessive wear and remove objects such as stones, nails or glass that may be wedged in the tread grooves. Check the tire and valve stems for holes, cracks, or cuts that may permit air leakage and repair or replace the tire and replace the valve stem. Inspect the tire sidewalls for cracking, cuts, bruises and other signs of damage or excessive wear. If internal damage to the tire is suspected, have the tire demounted and inspected in case

it needs to be repaired or replaced. For your safety, tires that are damaged or show signs of excessive wear should not be used because they are more likely to blow out or fail.

Improper or inadequate vehicle maintenance can cause tires to wear abnormally. Inspect all your tires, including the spare, frequently, and replace them if one or more of the following conditions exist:

# Wheels and Tires

## Tire Wear

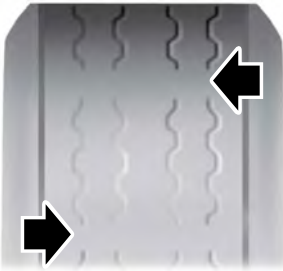

E142546

When the tread is worn down to one sixteenth of an inch (2 millimeters), tires must be replaced to help prevent your vehicle from skidding and hydroplaning. Built-in treadwear indicators, or wear bars, which look like narrow strips of smooth rubber across the tread will appear on the tire when the tread is worn down to one sixteenth of an inch (2 millimeters).

When the tire tread wears down to the same height as these wear bars, the tire is worn out and must be replaced.



## Damage

Periodically inspect the tire treads and sidewalls for damage (such as bulges in the tread or sidewalls, cracks in the tread groove and separation in the tread or sidewall). If damage is observed

or suspected have the tire inspected by a tire professional. Tires can be damaged during off-road use, so inspection after off-road use is also recommended.

## Age

### WARNINGS

-  Tires degrade over time depending on many factors such as weather, storage conditions, and conditions of use (load, speed, inflation pressure) the tires experience throughout their lives.
-  In general, tires should be replaced after six years regardless of tread wear or even if they have not been used. However, heat caused by hot climates or frequent high-load conditions can accelerate the aging process and may require you to replace tires more frequently.
-  You should replace your spare tire when you replace the road tires or after six years due to aging even if it has not been used.

# Wheels and Tires

## U.S. DOT Tire Identification Number

Both United States and Canada Federal regulations require tire manufacturers to place standardized information on the sidewall of all tires. This information identifies and describes the fundamental characteristics of the tire and also provides a U.S. DOT Tire Identification Number for safety standard certification and in case of a recall.

This begins with the letters DOT and indicates that the tire meets all federal standards. The next two numbers or letters are the plant code designating where it was manufactured, the next two are the tire size code and the last four numbers represent the week and year the tire was built. For example, the numbers 317 mean the 31st week of 1997. After 2000 the numbers go to four digits. For example, 2501 means the 25th week of 2001. The numbers in between are identification codes used for traceability. This information is used to contact customers if a tire defect requires a recall.

## Tire Replacement Requirements

Your vehicle is equipped with tires designed to provide a safe ride and handling capability.

## WARNINGS



Only use replacement tires and wheels that are the same size, load index, speed rating and type (such as P-metric versus LT-metric or all-season versus all-terrain) as those originally provided by Ford. The recommended tire and wheel size may be found on either the Safety Compliance Certification Label (affixed to either the door hinge pillar, door-latch post, or the door edge that meets the door-latch post, next to the driver's seating position), or the Tire Label which is located on the B-Pillar or edge of the driver's door. If this information is not found on these labels, then you should contact your authorized dealer as soon as possible. Use of any tire or wheel not recommended by Ford can affect the safety and performance of your vehicle, which could result in an increased risk of loss of vehicle control, vehicle rollover, personal injury and death.



To reduce the risk of serious injury, when mounting replacement tires and wheels, you should not exceed the maximum pressure indicated on the sidewall of the tire to set the beads without additional precautions listed below. If the beads do not seat at the maximum pressure indicated, re-lubricate and try again.

# Wheels and Tires

---

## WARNINGS

When inflating the tire for mounting pressures up to 20 psi (1.38 bar) greater than the maximum pressure on the tire sidewall, the following precautions must be taken to protect the person mounting the tire:

1. Make sure that you have the correct tire and wheel size.

2. Lubricate the tire bead and wheel bead seat area again.

3. Stand at a minimum of 12 ft (3.66 m) away from the wheel and tire assembly.

4. Use both eye and ear protection.



For a mounting pressure more than 20 psi (1.38 bar) greater than the maximum pressure, a Ford dealer or other tire service professional should do the mounting.



Always inflate steel carcass tires with a remote air fill with the person inflating standing at a minimum of 12 ft (3.66 m) away from the wheel and tire assembly.

---

**Important:** Remember to replace the wheel valve stems when the road tires are replaced on your vehicle.

The two front tires or two rear tires should generally be replaced as a pair.

The tire pressure sensors mounted in the wheels are not designed to be used in aftermarket wheels.

The use of wheels or tires not recommended by Ford Motor Company may affect the operation of your tire pressure monitoring system.

If the tire pressure monitoring system indicator is flashing, the system is malfunctioning. Your replacement tire might be incompatible with your tire pressure monitoring system, or some component of the system may be damaged.

## Replacing a Tire That is Greenhouse Gas Certified

The tires installed on this vehicle at the factory as original equipment are certified for Greenhouse Gas and Fuel Efficiency regulations.

Replacement tires must be of equal or lower rolling resistance level (TRRL or Crr). Consult with your tire supplier(s) for appropriate replacement tires.

# Wheels and Tires

---

## Safety Practices

### WARNINGS



If your vehicle is stuck in snow, mud or sand, do not rapidly spin the tires; spinning the tires can tear the tire and cause an explosion. A tire can explode in as little as three to five seconds.



Do not spin the wheels at over 34 mph (55 km/h). The tires may fail and injure a passenger or bystander.

---

## Driving habits have a great deal to do with your tire mileage and safety.

- \*Observe posted speed limits.
- \*Avoid fast starts, stops and turns.
- \*Avoid potholes and objects on the road.
- \*Do not run over curbs or hit the tire against a curb when parking.

## Highway Hazards

No matter how carefully you drive there's always the possibility that you may eventually have a flat tire on the highway. Drive slowly to the closest safe area out of traffic. This may further damage the flat tire, but your safety is more important.

If you feel a sudden vibration or ride disturbance while driving, or you suspect your tire or vehicle has been damaged, immediately reduce your speed. Drive with caution until you can safely pull off the road. Stop and inspect the tires for damage. If a tire is under-inflated or damaged, deflate it, remove wheel and replace it with your spare tire and wheel. If you cannot detect a cause, have the vehicle towed to the nearest repair facility or tire dealer to have the vehicle inspected.

## Tire and Wheel Alignment

A bad jolt from hitting a curb or pothole can cause the front end of your vehicle to become misaligned or cause damage to your tires. If your vehicle seems to pull to one side when you're driving, the wheels may be out of alignment. Have an authorized dealer check the wheel alignment periodically.

Wheel misalignment in the front or the rear can cause uneven and rapid treadwear of your tires and should be corrected by an authorized dealer. Front-wheel drive vehicles and those with an independent rear suspension may require alignment of all four wheels.

The tires should also be balanced periodically. An unbalanced tire and wheel assembly may result in irregular tire wear.



# Wheels and Tires

## Tire Rotation

### WARNING

 If the tire label shows different tire pressures for the front and rear tires and the vehicle has a tire pressure monitoring system, then you need to update the settings for the system sensors. Always perform the system reset procedure after tire rotation. If you do not reset the system, it may not provide a low tire pressure warning when necessary.

**Note:** *If your tires show uneven wear ask an authorized dealer to check for and correct any wheel misalignment, tire imbalance or mechanical problem involved before tire rotation.*

**Note:** *Your vehicle may be equipped with a dissimilar spare wheel and tire assembly. A dissimilar spare wheel and tire assembly is defined as a spare wheel and tire assembly that is different in brand, size or appearance from the road tires and wheels. If you have a dissimilar spare wheel and tire assembly it is intended for temporary use only and should not be used in a tire rotation.*

**Note:** *After having your tires rotated, inflation pressure must be checked and adjusted to the vehicle requirements.*

Rotating your tires at the recommended interval (as indicated in the Scheduled Maintenance chapter) will help your tires wear more evenly, providing better tire performance and longer tire life. Sometime irregular tire wear can be corrected by rotating the tires.

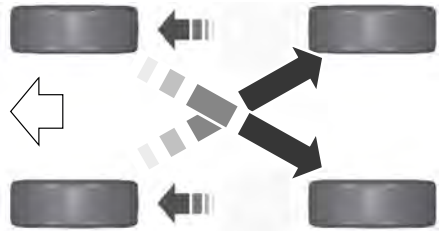

E142548

Rear-wheel drive vehicles and four-wheel drive vehicles (front tires at left of diagram).

## Wheels and Tires

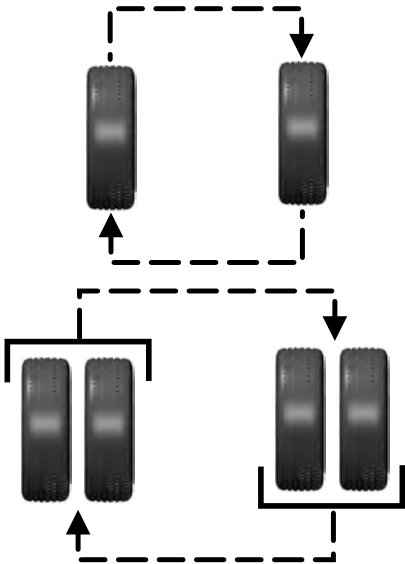

E166988

Dual rear wheel drive vehicle - six tire rotation (front tires at top of diagram).

If your vehicle is equipped with dual rear wheels it is recommended that the front and rear tires (in pairs) be rotated only side to side. We do not recommend splitting up the dual rear wheels. Rotate them side to side as a set. After tire rotation, inflation pressures must be adjusted for the tires new positions in accordance with vehicle requirements.

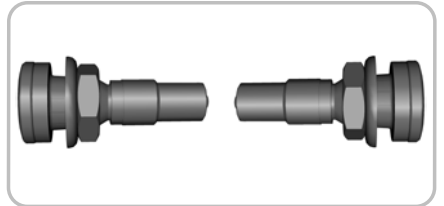

E227387

**Note:** When installing 17-inch dual rear wheels, align the valve stems facing each other.

# Wheels and Tires

## USING SNOW CHAINS

### WARNING



Snow tires must be the same size, load index, speed rating as those originally provided by Ford. Use of any tire or wheel not recommended by Ford can affect the safety and performance of your vehicle, which could result in an increased risk of loss of vehicle control, vehicle rollover, personal injury and death. Additionally, the use of non-recommended tires and wheels could cause steering, suspension, axle, transfer case or power transfer unit failure.

**Note:** Do not use snow chains on vehicles with 20 inch wheels and tires.

The tires on your vehicle have all-weather treads to provide traction in rain and snow. However, in some climates, you may need to use snow tires and cables. If you need to use cables, it is recommended that steel wheels (of the same size and specifications) be used, as cables may chip aluminum wheels.

**Note:** The suspension insulation and bumpers will help prevent vehicle damage. Do not remove these components from your vehicle when using snow tires and chains.

Follow these guidelines when using snow tires and chains:

- If possible, avoid fully loading your vehicle
- Use only SAE Class S chains.
- Install chains securely, verifying that the chains do not touch any wiring, brake lines or fuel lines.

- Drive cautiously. If you hear the chains rub or bang against your vehicle, stop and retighten the chains. If this does not work, remove the chains to prevent damage to your vehicle.
- Remove the tire chains when they are no longer needed. Do not use tire chains on dry roads.

If you have any questions regarding snow chains or cables, please contact your authorized dealer.

## TIRE PRESSURE MONITORING SYSTEM

### Vehicle Tire Pressure Monitoring System

### WARNING



The tire pressure monitoring system is not a substitute for manually checking tire pressures. You should periodically check tire pressures using a pressure gauge. Failure to correctly maintain tire pressures could increase the risk of tire failure, loss of control, vehicle rollover and personal injury.



Each tire, including the spare (if provided), should be checked monthly when cold and inflated to the inflation pressure recommended by the vehicle manufacturer on the vehicle placard or tire inflation pressure label. (If your vehicle has tires of a different size than the size indicated on the vehicle placard or tire inflation pressure label, you should determine the proper tire inflation pressure for those tires.)

# Wheels and Tires

As an added safety feature, your vehicle has been equipped with a Tire Pressure Monitoring System (TPMS) that illuminates a low tire pressure telltale when one or more of your tires is significantly under-inflated. Accordingly, when the low tire pressure telltale illuminates, you should stop and check your tires as soon as possible, and inflate them to the proper pressure. Driving on a significantly under-inflated tire causes the tire to overheat and can lead to tire failure. Under-inflation also reduces fuel efficiency and tire tread life, and may affect the vehicle's handling and stopping ability.

Please note that the TPMS is not a substitute for proper tire maintenance, and it is the driver's responsibility to maintain correct tire pressure, even if under-inflation has not reached the level to trigger illumination of the TPMS low tire pressure telltale.

Your vehicle has also been equipped with a TPMS malfunction indicator to indicate when the system is not operating properly. The TPMS malfunction indicator is combined with the low tire pressure telltale. When the system detects a malfunction, the telltale will flash for approximately one minute and then remain continuously illuminated. This sequence will continue upon subsequent vehicle start-ups as long as the malfunction exists.

When the malfunction indicator is illuminated, the system may not be able to detect or signal low tire pressure as intended. TPMS malfunctions may occur for a variety of reasons, including the installation of replacement or alternate tires or wheels on the vehicle that prevent the TPMS from functioning properly. Always check the TPMS malfunction telltale after replacing one or more tires or wheels on your vehicle to ensure that the replacement or alternate tires and wheels allow the TPMS to continue to function properly.

This device complies with Part 15 of the FCC Rules and with Industry Canada license-exempt RSS standard(s). Operation is subject to the following two conditions:

- This device may not cause harmful interference.
- This device must accept any interference received, including interference that may cause undesired operation.

## Changing Tires With a Tire Pressure Monitoring System



E142549

**Note:** Each road tire is equipped with a tire pressure sensor located inside the wheel and tire assembly cavity. The pressure sensor is attached to the valve stem. The pressure sensor is covered by the tire and is not visible unless the tire is removed. Take care when changing the tire to avoid damaging the sensor.

You should always have your tires serviced by an authorized dealer.

Check the tire pressure periodically (at least monthly) using an accurate tire gauge. See *Inflating Your Tires* in this chapter.

# Wheels and Tires

## Understanding Your Tire Pressure Monitoring System

### Single Rear Wheel



### Dual Rear Wheel



The tire pressure monitoring system measures pressure in your road tires and sends the tire pressure readings to your vehicle. The low tire pressure warning light will turn on if the tire pressure is significantly low. Once the light is illuminated, one or more of your tires are under-inflated and needs to be inflated to the manufacturer's recommended tire pressure. Even if the light turns on and a short time later turns off, your tire pressure still needs to be checked.

### ***When Your Temporary Spare Tire is Installed***

When one of your road tires needs to be replaced with the temporary spare, the system will continue to identify an issue to remind you that the damaged road wheel and tire assembly needs to be repaired and put back on your vehicle.

To restore the full function of the tire pressure monitoring system, have the damaged road wheel and tire assembly repaired and remounted on your vehicle.

### ***When You Believe Your System is Not Operating Properly***

The main function of the tire pressure monitoring system is to warn you when your tires need air. It can also warn you in the event the system is no longer capable of functioning as intended. See the following chart for information concerning your tire pressure monitoring system:

# Wheels and Tires

<b>Low tire pressure warning light</b>	<b>Possible cause</b>	<b>Customer action required</b>
Solid warning light	Tire under inflated	Make sure tires are at the proper pressure. See <b>Inflating your tires</b> in this chapter. After inflating your tires to the manufacturer's recommended pressure as shown on the Tire Label (located on the edge of driver's door or the B-Pillar), the vehicle must be driven for at least two minutes over 20 mph (32 km/h) before the light turns off.
	Spare tire in use	Repair the damaged road wheel and tire assembly and reinstall it on the vehicle to restore system function. For a description on how the system functions, see <b>When your temporary spare tire is installed</b> in this section.
	Tire pressure monitoring system malfunction	If the tires are properly inflated and the spare tire is not in use but the light remains on, contact your authorized dealer as soon as possible.
	Tire rotation without sensor training	On vehicles with different front and rear tire pressures, the system must be retrained following every tire rotation. See <b>Tire Care</b> (page 382).
Flashing warning light	Spare tire in use	Repair the damaged road wheel and tire assembly and reinstall it on the vehicle to restore system function. For a description on how the system functions, see <b>When your temporary spare tire is installed</b> in this section.
	Tire pressure monitoring system malfunction	If the tires are properly inflated and the spare tire is not in use but the light remains on, contact your authorized dealer as soon as possible.

# Wheels and Tires

## When Inflating Your Tires

When putting air into your tires (such as at a gas station or in your garage), the tire pressure monitoring system may not respond immediately to the air added to your tires.

It may take up to two minutes of driving over 20 mph (32 km/h) for the light to turn off after you have filled your tires to the recommended inflation pressure.

## How Temperature Affects Your Tire Pressure

The tire pressure monitoring system monitors tire pressure in each pneumatic tire. While driving in a normal manner, a typical passenger tire inflation pressure may increase about 2 to 4 psi (14 to 28 kPa) from a cold start situation. If the vehicle is stationary overnight with the outside temperature significantly lower than the daytime temperature, the tire pressure may decrease about 3 psi (21 kPa) for a drop of 30°F (17°C) in ambient temperature. This lower pressure value may be detected by the tire pressure monitoring system as being significantly lower than the recommended inflation pressure and activate the system warning light for low tire pressure.

If the low tire pressure warning light is on, visually check each tire to verify that no tire is flat. If one or more tires are flat, repair as necessary. Check the air pressure in the road tires. If any tire is under-inflated, carefully drive the vehicle to the nearest location where air can be added to the tires. Inflate all the tires to the recommended inflation pressure.

## Tire Pressure Monitoring System Reset Procedure

### WARNING



To determine the required pressure(s) for your vehicle, see the Safety Compliance Certification Label (on the door hinge pillar, door-latch post or the door edge that meets the door-latch post, next to the driver seat) or the Tire Label on the B-Pillar or the edge of the driver door.

**Note:** *You need to perform the tire pressure monitoring system reset procedure after each tire rotation.*

To provide the vehicle's load carrying capability, some vehicles require different recommended tire pressures in the front tires as compared to the rear tires. The tire pressure monitoring system equipped on these vehicles is designed to illuminate the low tire pressure warning light at two different pressures; one for the front tires and one for the rear tires.

Since tires need to be rotated to provide consistent performance and maximum tire life, the tire pressure monitoring system needs to know when the tires are rotated to determine which set of tires are on the front and which are on the rear. With this information, the system can detect and properly warn of low tire pressures.

System reset tips:

# Wheels and Tires

---

- To reduce the chances of interference from another vehicle, perform the system reset procedure at least three feet (one meter) away from another Ford Motor Company vehicle undergoing the system reset procedure at the same time.
  - Do not wait more than two minutes between resetting each tire sensor or the system will time-out and the entire procedure will have to be repeated on all four wheels.
  - A double horn will sound indicating the need to repeat the procedure.
5. Train the tire pressure monitoring system sensors in the tires using the following system reset sequence starting with the left front tire in the following clockwise order: Left front (driver's side front tire), Right front (passenger's side front tire), Right rear (passenger's side rear tire), Left rear (driver's side rear tire).
  6. Remove the valve cap from the valve stem on the left front tire. Decrease the air pressure until the horn sounds.

## **Performing the System Reset Procedure (Single Rear Wheel)**

Read the entire procedure before attempting.

1. Drive the vehicle above 20 mph (32 km/h) for at least two minutes, then park in a safe location where you can easily get to all four tires and have access to an air pump.
2. Place the ignition in the off position and keep the key in the ignition.
3. Cycle the ignition to the on position with the engine off.
4. Turn the hazard flashers on then off three times. You must accomplish this within 10 seconds. If the reset mode has been entered successfully, the horn will sound once, the system indicator will flash and a message is shown in the information display. If this does not occur, please try again starting at Step 2. If after repeated attempts to enter the reset mode, the horn does not sound, the system indicator does not flash and no message is shown in the information display, seek service from your authorized dealer.
7. Remove the valve cap from the valve stem on the right front tire. Decrease the air pressure until the horn sounds.
8. Remove the valve cap from the valve stem on the right rear tire. Decrease the air pressure until the horn sounds.
9. Remove the valve cap from the valve stem on the left rear tire. Decrease the air pressure until the horn sounds. Training is complete after the horn sounds for the last tire trained (driver's side rear tire), the system indicator stops flashing, and a message is shown in the information display.
10. Turn the ignition off. If two short horn beeps are heard, the reset procedure was unsuccessful and you must repeat it. If after repeating the procedure and two short beeps are heard when the ignition is turned to off, seek assistance from your authorized dealer.

**Note:** *The single horn chirp confirms that the sensor identification code has been learned by the module for this position. If a double horn is heard, the reset procedure was unsuccessful, and you must repeat it.*



# Wheels and Tires

---

11. Set all four tires to the recommended air pressure as indicated on the Safety Compliance Certification Label (affixed to either the door hinge pillar, door-latch post, or the door edge that meets the door-latch post, next to the driver's seating position) or Tire Label located on the B-Pillar or the edge of the driver's door.
5. Train the tire pressure monitoring system sensors in the tires using the following system reset sequence starting with the left front tire in the following order: Left front (driver's side front tire), Right front (passenger's side front tire), Right outer rear (passenger's side rear outer tire), Right inner rear (passenger's side rear inner tire), Left outer rear (driver's side rear outer tire), Left inner rear (driver's side rear inner tire).

## **Performing the System Reset Procedure (Dual Rear Wheel)**

For further information see **Understanding Your Tire Pressure Monitoring System** and refer to **Dual Rear Wheel**, earlier in this section.

Read the entire procedure before attempting.

1. Drive the vehicle above 20 mph (32 km/h) for at least two minutes, then park in a safe location where you can easily get to all six tires and have access to an air pump.
  2. Place the ignition in the off position and keep the key in the ignition.
  3. Cycle the ignition to the on position with the engine off.
  4. Turn the hazard flashers on then off three times. You must accomplish this within 10 seconds. If the reset mode has been entered successfully, the horn will sound once, the system indicator will flash and a message is shown in the information display. If this does not occur, please try again starting at Step 2. If after repeated attempts to enter the reset mode, the horn does not sound, the system indicator does not flash and no message is shown in the information display, seek service from your authorized dealer.
  6. Remove the valve cap from the valve stem on the left front tire. Decrease the air pressure until the horn sounds.
- Note:** *The single horn chirp confirms that the sensor identification code has been learned by the module for this position. If a double horn is heard, the reset procedure was unsuccessful, and you must repeat it.*
7. Remove the valve cap from the valve stem on the right front tire. Decrease the air pressure until the horn sounds.
  8. Remove the valve cap from the valve stem on the right outer rear tire. Decrease the air pressure until the horn sounds.
  9. Remove the valve cap from the valve stem on the right inner rear tire. Decrease the air pressure until the horn sounds.
  10. Remove the valve cap from the valve stem on the left outer rear tire. Decrease the air pressure until the horn sounds.
  11. Remove the valve cap from the valve stem on the left inner rear tire. Decrease the air pressure until the horn sounds. Training is complete after the horn sounds for the last tire trained, the system indicator stops flashing, and a message is shown in the information display.

# Wheels and Tires

- Turn the ignition off. If two short horn beeps are heard, the reset procedure was unsuccessful and you must repeat it. If after repeating the procedure and two short beeps are heard when the ignition is turned off, seek assistance from your authorized dealer.
- Set all six tires to the recommended air pressure as indicated on the Safety Compliance Certification Label (affixed to either the door hinge pillar, door-latch post, or the door edge that meets the door-latch post, next to the driver's seating position) or Tire Label located on the B-Pillar or the edge of the driver's door.

## Trailer Tire Pressure Monitoring System (If Equipped)

**Note:** Additional equipment may be required for your vehicle to support trailer tire pressure monitoring. See your authorized dealer for more information.

**Note:** The trailer tire pressure monitoring system is not a substitute for proper tire maintenance. It is your responsibility to maintain correct tire pressures at all times.

**Note:** If a trailer tire is repaired, replaced or broken down for service, the screw and valve on the trailer tire pressure sensor should be replaced. See your authorized dealer for details.

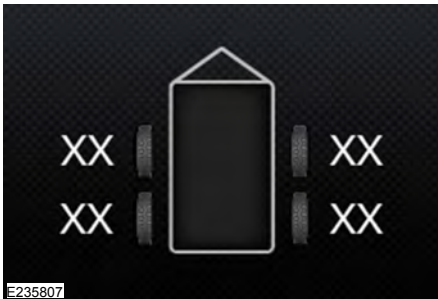

The trailer tire pressure monitoring system is an added safety feature that allows you to view your trailer tire pressures through the information display. See **General Information** (page 113). Tire pressure sensors are mounted into each tire on your trailer. The sensors send a message to your vehicle indicating the current trailer tire pressure.

If the trailer tire pressure monitoring system detects that a tire is low, a warning message appears in the information display. The trailer tire pressure status screen in the information display highlights the tire with a low pressure.

The main function of the trailer tire pressure monitoring system is to warn you when your trailer tires need air. It can also warn you in the event the system is no longer capable of functioning as intended. See **Information Messages** (page 129).

## When a Temporary Spare or New Tire is Installed

If you have replaced a trailer tire with a new or spare tire, a warning message appears and pressure readings are no longer displayed for that tire.

To restore the full function of the trailer tire pressure monitoring system:

- Have the damaged wheel and tire assembly repaired and remounted to your trailer.
- Install the trailer tire pressure monitoring sensor into the new wheel and tire assembly.
- Perform the trailer tire pressure monitoring system reset procedure.

## Trailer Tire Pressure Monitoring System Reset Procedure

**Note:** You need to perform the tire pressure monitoring system reset procedure after each tire rotation, or when a new trailer tire pressure sensor is installed into a trailer tire.

# Wheels and Tires

The trailer tire pressure monitoring system can be reset through the menu in the information display. See **General Information** (page 113). Performing the trailer setup process also resets the trailer tire pressure monitoring system.

## CHANGING A ROAD WHEEL

### WARNING



If the tire pressure monitor sensor becomes damaged it may not function.

**Note:** *If your vehicle is equipped with the tire pressure monitoring system, the indicator light illuminates when the spare tire is in use. To restore the full function of the monitoring system, all road wheels equipped with tire pressure monitoring sensors must be mounted on the vehicle.*

**Note:** *You should only use tire sealants in roadside emergencies as they may cause damage to the tire pressure monitoring system sensor.*

If you get a flat tire when driving, do not apply the brake heavily. Instead, gradually decrease your speed. Hold the steering wheel firmly and slowly move to a safe place on the side of the road.

If your vehicle is equipped with the tire pressure monitoring system, have a flat serviced by an authorized dealer in order to prevent damage to the system sensors. See **Tire Pressure Monitoring System** (page 400). Replace the spare tire with a road tire as soon as possible. During repairing or replacing of the flat tire, have the authorized dealer inspect the system sensor for damage.

## Dissimilar Spare Wheel and Tire Assembly Information

### WARNING



Failure to follow these guidelines could result in an increased risk of loss of vehicle control, injury or death.

If you have a dissimilar spare wheel and tire, then it is intended for temporary use only. This means that if you need to use it, you should replace it as soon as possible with a road wheel and tire assembly that is the same size and type as the road tires and wheels that were originally provided by Ford. If the dissimilar spare tire or wheel is damaged, it should be replaced rather than repaired.

A dissimilar spare wheel and tire assembly is defined as a spare wheel and tire assembly that is different in brand, size or appearance from the road tires and wheels.

### Full-size dissimilar spare

When driving with the full-size dissimilar spare wheel and tire assembly, do not:

- Exceed 70 mph (113 km/h).
- Use more than one dissimilar spare wheel and tire assembly at a time.
- Use snow chains on the end of the vehicle with the dissimilar spare wheel and tire assembly.

When driving with the full-size dissimilar spare wheel and tire assembly, it is recommended that you do not:

- Exceed 50 mph (80 km/h) in 4WD.
- Engage 4WD unless the vehicle is stationary.
- Use 4WD on dry pavement.

# Wheels and Tires

The usage of a full-size dissimilar spare wheel and tire assembly can lead to impairment of the following:

- Handling, stability and braking performance.
- Comfort and noise.
- Ground clearance and parking at curbs.
- Winter weather driving capability.
- Wet weather driving capability.
- Four-wheel drive capability.

When driving with the full-size dissimilar spare wheel and tire assembly additional caution should be given to:

- Towing a trailer.
- Driving vehicles equipped with a camper body.
- Driving vehicles with a load on the cargo rack.

Drive cautiously when using a full-size dissimilar spare wheel and tire assembly and seek service as soon as possible.

## Location of the Spare Tire and Tools

If your vehicle is equipped with a spare tire, jack and associated tools, see the following table for their locations:

Tool	Location
Spare tire - pick-up trucks only	Under the vehicle, just forward of the rear bumper.
Jack	Fastened to the floor pan behind the rear-most seat on the passenger side.
Jack handle, lug wrench, lug wrench extension - only available on dual rear wheel vehicles and wheel chock - only available on single rear wheel vehicles equipped with a diesel engine.	Regular Cab: Fastened to floor behind the driver seat. Super Cab and Crew Cab: Fastened to the floor under the rear seat on the driver's side.

## Removing the Spare Tire (With Spare Tire Carrier Only)

The following tools are required to remove the spare tire:

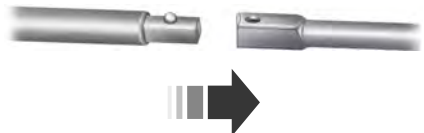

E162795

# Wheels and Tires

One handle extension and two typical extensions. To assemble, align the button with the hole and slide the parts together.

To disconnect, press the button and pull apart.

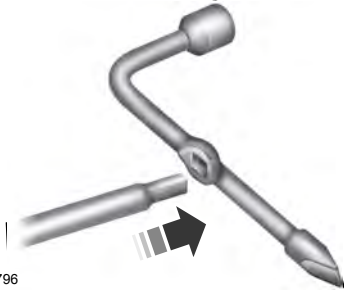

E162796

One wheel nut wrench. Slide over the square end of the jack handle.



E162797



E227181

1. Use the ignition key to open the lock at the rear bumper.
2. Fully insert the jack handle, with one extension, through the bumper hole and into the guide tube. You feel some resistance when you turn the jack handle assembly.
3. Turn the handle counterclockwise and lower the spare tire until you can slide the tire rearward and the cable is slack.
4. Remove the retainer through the center of the wheel.

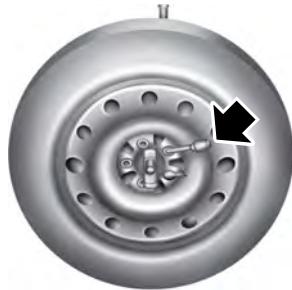

E162800

5. If not replacing the spare or flat tire to the underbody storage area, raise the wheel retainer up into the installed position.

## Tire Change Procedure

### WARNINGS





When one of the front wheels is off the ground, the transmission alone will not prevent the vehicle from moving or slipping off the jack, even if the transmission is in park (P).

# Wheels and Tires

## WARNINGS

 To help prevent your vehicle from moving when changing a wheel, shift the transmission into park (P), set the parking brake and use an appropriate block or wheel chock to secure the wheel diagonally opposite to the wheel being changed. For example, when changing the front left wheel, place an appropriate block or wheel chock on the right rear wheel.

 Do not get under a vehicle that is only supported by a vehicle jack.

 Do not attempt to change a tire on the side of the vehicle close to moving traffic. Pull far enough off the road to avoid the danger of being hit when operating the jack or changing the wheel.

 Always use the jack provided as original equipment with your vehicle. If using a jack other than the one provided, make sure the jack capacity is adequate for the vehicle weight, including any vehicle cargo or modifications. If you are unsure if the jack capacity is adequate, contact the authorized dealer.

 Only use the spare wheel carrier to stow the wheel provided with your vehicle. Other wheel sizes could cause the spare wheel carrier to fail if it does not fit securely or is too heavy.

**Note:** Do not use impact tools or power tools operating at over 200 RPM on the spare wheel carrier winch, which may cause it to malfunction and prevent a secure fit. Override the winch at least three times (there is an audible click each time) to make sure the wheel and tire fit securely.

**Note:** Passengers should not remain in the vehicle when the vehicle is being jacked.

Park on a level surface, set the parking brake and activate the hazard flashers.

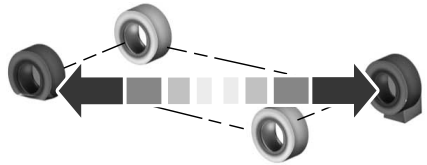

E142551

1. Turn the engine off and block the wheel that is diagonally opposite of the flat tire using the wheel chock.

**Note:** Lock the manual hub on the wheel if the vehicle is a 4x4.

2. Remove the jack, jack handle, lug wrench and spare tire from the stowage locations.
3. Use the tip of the lug wrench to remove any wheel trim.
4. Loosen each wheel lug nut  $\frac{1}{2}$  turn counterclockwise, but do not remove them until the wheel is raised off the ground.

**Note:** For vehicles with dual rear wheels, insert the lug wrench extension into the lug wrench to reach the lug nuts.

# Wheels and Tires

## F-250 and F-350 Single Rear Wheel Vehicles



E162801

1. Insert the hooked end of the jack handle into the jack and use the handle to slide the jack under the vehicle.
2. Position the jack according to the following guides:



E162802

Front (4x2)

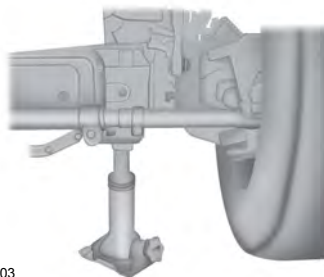

E162803

Front driver side (4x4)

**Note:** Make sure the jack fits onto the flat area on the outboard side of the differential.

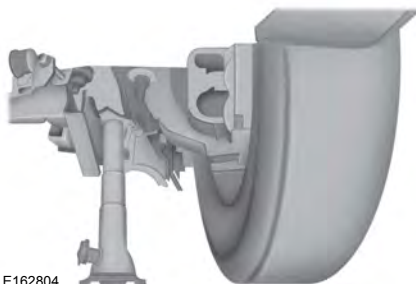

E162804

Front passenger side (4x4)

**Note:** View shown from the rear of the vehicle to clearly identify the jack point. Place the jack directly under the axle.

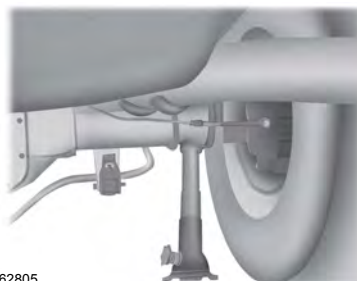

E162805

# Wheels and Tires

Rear

**Note:** Jack at the specified locations to avoid damage to the vehicle.

## Jacking the Vehicle



E162811

1. Turn the jack handle clockwise until the wheel is completely off the ground and high enough to install the spare tire.
2. Remove the lug nuts with the lug wrench.
3. Replace the flat tire with the spare tire, making sure the valve stem is facing outward for all front wheels and single rear wheel vehicles. If you are replacing an inboard rear tire on dual rear wheel vehicles, the valve stem must be facing outward. If you are replacing the outboard wheel, the valve stem must be facing inward. Reinstall the lug nuts until the wheel is snug against the hub. Do not fully tighten the lug nuts until the wheel has been lowered.
4. Lower the wheel by turning the jack handle counterclockwise.
5. Remove the jack and fully tighten the lug nuts in the order shown. See **Technical Specifications** (page 418).
6. Stow the flat tire. See **Stowing the flat or spare tire** if the vehicle is equipped with a spare tire carrier.

7. Stow the jack, jack handle and lug wrench. Make sure the jack is securely fastened so it does not rattle when driving.
8. Unblock the wheels.



E161441

## 8-lug nut torque sequence



E169375

## 10-lug nut torque sequence

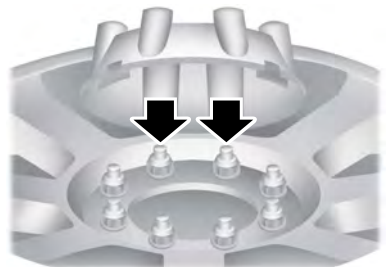

E162820



# Wheels and Tires

When installing the wheel center ornaments, make sure that the ornament retention towers on the back side of the ornament are aligned with the studs or lug nuts. The retention towers are designed to be installed over the studs or nuts and retain to the flange on the lug nut.



E162821

If the ornament retention towers are aligned between the studs or lug nuts, the ornament is improperly installed. This improper installation may appear and sound correct, but does not keep the ornament on the vehicle. Ornaments improperly installed in this manner, fall off or become loose with minimal force or impact.

## F-350 Dual Rear Wheel, F-450 and F-550 Vehicles



E162812

1. Slide the notched end of the jack handle over the release valve and use the handle to slide the jack under the vehicle. Make sure the valve is closed by turning it clockwise.
2. Position the jack according to the following guides:

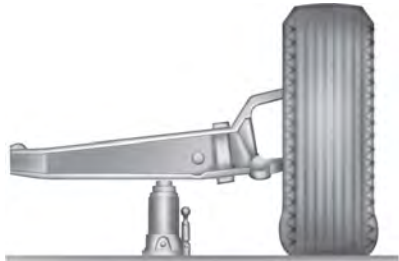

E162813

Front (4x2): F-350 dual rear wheel

**Note:** Place the jack directly under the I-beam.

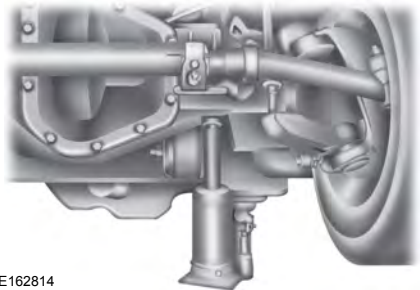

E162814

Front driver side (4x4): F-350 dual rear wheel

**Note:** Make sure the jack fits onto the flat area on the outboard side of the differential housing.

# Wheels and Tires

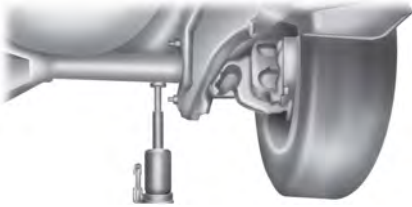

E162815

Front passenger side (4x4): F-350 dual rear wheel

**Note:** View shown from the rear of the vehicle to clearly identify the jack point.

**Note:** Place the jack directly under the axle and inboard of the radius arm so that the jack clears the radius arm.

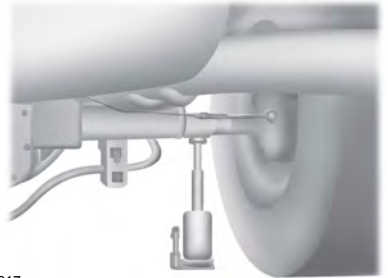

E162817

Rear: F-350 dual rear wheel

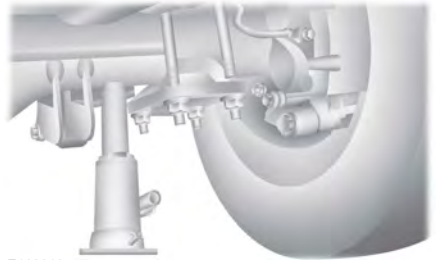

E162818

Rear: F-450 and F-550

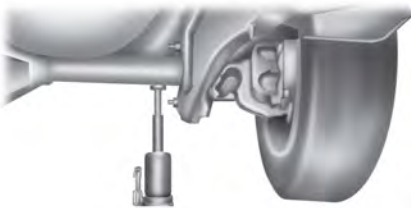

E162816

Front: F-450 and F-550

## Jacking the Vehicle

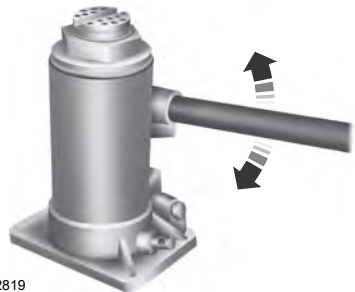

E162819

1. Insert the jack handle into the pump linkage.

# Wheels and Tires

- Use an up-and-down motion with the jack handle to raise the wheel completely off the ground.

**Note:** Hydraulic jacks are equipped with a pressure release valve that prevents lifting loads which exceed the jack's rated capacity.

- Remove the lug nuts with the lug wrench.
- Replace the flat tire with the spare tire, making sure the valve stem is facing outward on all front and inboard rear wheels. If you are replacing the outboard wheel, the valve stem must be facing inward. Reinstall the lug nuts until the wheel is snug against the hub. Do not fully tighten the lug nuts until the wheel has been lowered.
- Lower the wheel by slowly turning the release valve counterclockwise. Opening the release valve slowly provides a more controlled rate of descent.
- Remove the jack and fully tighten the lug nuts in the order shown. See **Technical Specifications** (page 418).
- Stow the flat tire. See Stowing the flat or spare tire if the vehicle is equipped with a spare tire carrier.
- Stow the jack, jack handle and lug wrench. Make sure the jack is securely fastened so it does not rattle when driving.
- Unblock the wheels.



E161441

8-lug nut torque sequence



E169375

10-lug nut torque sequence

## Installing Dual Rear Wheel Ornaments

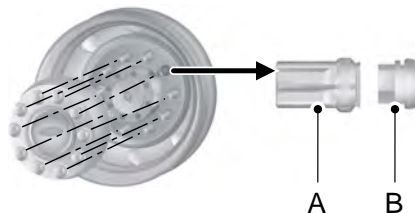

E162822

- Align the ornament with the lug nuts. A is the clip and B is the flange.

# Wheels and Tires

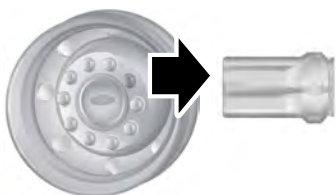

E162823

2. Hold the ornament so that all of the retention clips are sitting on the flange of the lug nuts.

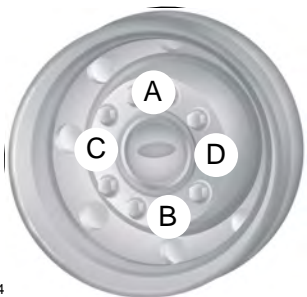

E162824

3. Use your hand or rubber mallet to tap the ornament in a star pattern. There should be an even gap between the ornament and the wheel.
4. Be sure to install all the clips on the nuts over the flanges so that there is an even gap all around and the retention clips are fully seated.



E162825



E162826

## Stowing the Flat or Spare Tire

**Note:** Failure to follow spare tire stowage instructions may result in failure of cable or loss of spare tire.

1. Place the tire on end with the valve stem facing toward the front of the vehicle.

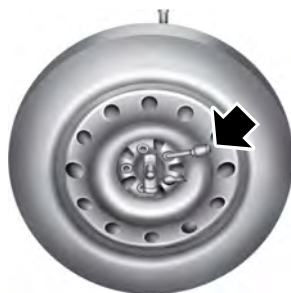

E162800

# Wheels and Tires

---

2. Lay the tire on the ground with the valve stem facing up.
3. Slide the wheel partially under the vehicle and install the retainer through the wheel center. Pull on the cable to align the components at the end of the cable.
4. Turn the jack handle clockwise until the tire is raised to its stowed position underneath the vehicle. The effort to turn the jack handle increases significantly and the spare tire carrier ratchets or slips when the tire is raised to the maximum tightness. Tighten to the best of your ability, to the point where the ratchet/slip occurs, if possible. The spare tire carrier does not allow you to overtighten. If the spare tire carrier ratchets or slips with little effort, take the vehicle to your authorized dealer for assistance at your earliest convenience.
5. Check that the tire lies flat against the frame and is properly tightened. Try to push or pull, then turn the tire to be sure it does not move. Loosen and retighten, if necessary. Failure to properly stow the spare tire may result in failure of the winch cable and loss of the tire.
6. Repeat this tightness check procedure when servicing the spare tire pressure, every six months, per scheduled maintenance information, or at any time that the spare tire is disturbed through service of other components.

## TECHNICAL SPECIFICATIONS

### Wheel Lug Nut Torque Specifications

#### WARNING



When a wheel is installed, always remove any corrosion, dirt or foreign materials present on the mounting surfaces of the wheel or the surface of the wheel hub, brake drum or brake disc that contacts the wheel. Make sure that any fasteners that attach the rotor to the hub are secured so they do not interfere with the mounting surfaces of the wheel. Installing wheels without correct metal-to-metal contact at the wheel mounting surfaces can cause the wheel nuts to loosen and the wheel to come off while the vehicle is in motion, resulting in loss of control.

---

# Wheels and Tires

Bolt size	lb.ft (Nm)
M14 x 1.5	165 lb.ft (224 Nm)

\*Torque specifications are for nut and bolt threads free of dirt and rust. Use only Ford recommended replacement fasteners.

On vehicles equipped with single rear wheels, retighten the lug nuts to the specified torque at 100 miles (160 kilometers) after any wheel disturbance (such as tire rotation, changing a flat tire, wheel removal).

On vehicles equipped with dual rear wheels, retighten the wheel lug nuts to the specified torque at 100 miles (160 kilometers), and again at 500 miles (800 kilometers) of new vehicle operation and after any wheel disturbance (such as tire rotation, changing a flat tire, wheel removal).

It is important to follow the proper wheel mounting and lug nut torque procedures.

On all two-piece flat wheel nuts, apply one drop of motor oil between the flat washer and the nut. Do not apply motor oil to the wheel nut threads or the wheel stud threads.



E161443



E145950

## A Wheel pilot bore

Inspect the wheel pilot hole and mounting surface prior to installation. Remove any visible corrosion or loose particles.

# Capacities and Specifications

## ENGINE SPECIFICATIONS - 6.2L

Engine	6.2L V8 Engine
Cubic inches	378
Required fuel	Minimum 87 octane
Firing order	1-5-4-8-6-3-7-2
Ignition system	Coil on plug
Spark plug gap	0.041-0.047 in (1.04-1.20 mm)
Compression ratio	9.8:1

## Drivebelt Routing

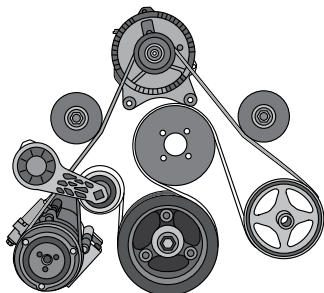

E163761

## ENGINE SPECIFICATIONS - 6.7L DIESEL

Engine	6.7L Diesel
Cubic inches	406
Required fuel	Low Sulfur Diesel up to B20
Firing order	1-3-7-2-6-5-4-8
Compression ratio	16.2:1

# Capacities and Specifications

## Drivebelt Routing Single Alternator

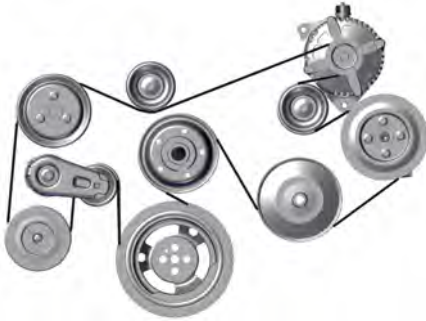

E224819

## Dual Alternator



E224820

## ENGINE SPECIFICATIONS - 6.8L

Engine	6.8L V10 Engine
Cubic inches	413
Required fuel	Minimum 87 octane
Firing order	1-6-5-10-2-7-3-8-4-9
Ignition system	Coil on plug
Spark plug gap	0.039 - 0.043 in (1.00 - 1.10 mm)
Compression ratio	9.2:1



# Capacities and Specifications

## Drivebelt Routing

### 6.8L Engines with A/C



E163762

### 6.8L Engines without A/C



E163763

## MOTORCRAFT PARTS - 6.2L

Component	Motorcraft Part number
Air filter element	FA-1928
Oil filter	FL-820-S
Battery (XL)	BXT-65-650
Battery (all except XL)	BXT-65-750
Spark plugs-platinum	SP-526
Windshield wiper blade	WW-2247
Transmission fluid filter	FT-187
Cabin air filter	FP-79

For scheduled maintenance, we recommend Motorcraft® replacement parts available at your Ford dealer or at [fordparts.com](http://fordparts.com). These parts meet or exceed Ford Motor Company's specifications and are engineered for your vehicle. Use of other parts may impact vehicle performance, emissions and durability. Your warranty may be void for any damage related to use of other parts.

If a Motorcraft® oil filter is not available, use an oil filter that meets industry performance specification SAE/USCAR-36.

For spark plug replacement, contact an authorized dealer. Replace the spark plugs at the appropriate intervals. See **Scheduled Maintenance** (page 581).

## Capacities and Specifications

---

### MOTORCRAFT PARTS - 6.7L DIESEL

<b>Component</b>	<b>Motorcraft Part number</b>
Engine oil filter	FL-2051S
Foam pre-filter	FA-1927
Air filter	FA-1926
Fuel filter	FG-1147
Battery (Two)	BXT-65-750
Windshield wiper blade	WW-2247
Cabin air filter	FP-79
Transmission filter	FT-187

For scheduled maintenance, we recommend Motorcraft® replacement parts available at your Ford dealer or at [fordparts.com](http://fordparts.com). These parts meet or exceed Ford Motor Company's specifications and are engineered for your vehicle. Use of other parts may impact vehicle performance, emissions and durability. Your warranty may be void for any damage related to use of other parts.

If a Motorcraft® oil filter is not available, use an oil filter that meets industry performance specification SAE/USCAR-36.

## Capacities and Specifications

---

### MOTORCRAFT PARTS - 6.8L

Component	Motorcraft Part number
Air filter element.	FA-1928
Oil filter.	FL-820-S
Battery (XL).	BXT-65-650
Battery (all except XL).	BXT-65-750
Spark plugs-platinum.	SP-509
Windshield wiper blade.	WW-2247
Transmission fluid filter	FT-187
Cabin air filter.	FP-79

For scheduled maintenance, we recommend Motorcraft® replacement parts available at your Ford dealer or at [fordparts.com](http://fordparts.com). These parts meet or exceed Ford Motor Company's specifications and are engineered for your vehicle. Use of other parts may impact vehicle performance, emissions and durability. Your warranty may be void for any damage related to use of other parts.

If a Motorcraft® oil filter is not available, use an oil filter that meets industry performance specification SAE/USCAR-36/USC-D.

For spark plug replacement, contact an authorized dealer. Replace the spark plugs at the appropriate intervals. See **Normal Scheduled Maintenance** (page 584).

# Capacities and Specifications

## VEHICLE IDENTIFICATION NUMBER

The vehicle identification number is located on the left-hand side of the instrument panel.



E142476

Please note that in the graphic, XXXX is representative of your vehicle identification number.

The Vehicle Identification Number contains the following information:

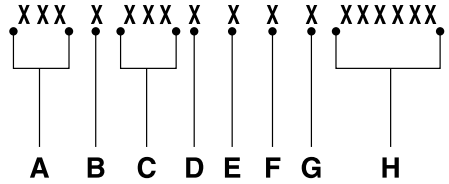

E142477

- A World manufacturer identifier
- B Brake system, Gross Vehicle Weight Rating, Restraint Devices and their locations
- C Make, vehicle line, series, body type
- D Engine type
- E Check digit
- F Model year
- G Assembly plant
- H Production sequence number

# Capacities and Specifications

## VEHICLE CERTIFICATION LABEL

**MFD. BY FORD MOTOR CO.**

DATE: XX/XX      GVWR: XXXX KG (XXXX LB)  
 FRONT GAWR:      REAR GAWR:  
 XXXX KG (XXXX LB)      WITH XXXX KG (XXXX LB)      WITH  
 XXXXXXXXXXXXXXXX      TIRES XXXXXXXXXXXXXXXX      TIRES  
 XXXXXXXX      RIMS XXXXXXXX      RIMS  
 AT XXXX kPa/ XXX PSI COLD      AT XXXX kPa/ XXX PSI COLD

THIS VEHICLE CONFORMS TO ALL APPLICABLE FEDERAL MOTOR VEHICLE SAFETY AND THEFT PREVENTION STANDARDS IN EFFECT ON THE DATE OF MANUFACTURE SHOWN ABOVE.

VIN: XXXXXXXXXXXXXXXX      XXXXX  
 TYPE: XXXX      XXXXX



EXT PNT: XX	XXXXXX	RC: XX	D50: XXXX
WB	INT TR	TP/PS	TR
XXX	XX	XXX	X
		XX	X
		XXXX	XXXX
		XXXXXXXXXXXX	XXX
			XXXX-XXXXXXXX-XX

E167469

The National Highway Traffic Safety Administration Regulations require that a Safety Compliance Certification Label be affixed to a vehicle and prescribe where the Safety Compliance Certification Label may be located. The Safety Compliance Certification Label shall be affixed to either the door hinge pillar, the door latch post, or the edge of the door near the door latch, next to the driver's seating position.

## TRANSMISSION CODE DESIGNATION

**MFD. BY FORD MOTOR CO.**

DATE: XX/XX      GVWR: XXXX KG (XXXX LB)  
 FRONT GAWR:      REAR GAWR:  
 XXXX KG (XXXX LB)      WITH XXXX KG (XXXX LB)      WITH  
 XXXXXXXXXXXXXXXX      TIRES XXXXXXXXXXXXXXXX      TIRES  
 XXXXXXXX      RIMS XXXXXXXX      RIMS  
 AT XXXX kPa/ XXX PSI COLD      AT XXXX kPa/ XXX PSI COLD

THIS VEHICLE CONFORMS TO ALL APPLICABLE FEDERAL MOTOR VEHICLE SAFETY AND THEFT PREVENTION STANDARDS IN EFFECT ON THE DATE OF MANUFACTURE SHOWN ABOVE.

VIN: XXXXXXXXXXXXXXXX      XXXXX  
 TYPE: XXXX      XXXXX



EXT PNT: XX	XXXXXX	RC: XX	D50: XXXX
WB	INT TR	TP/PS	TR
XXX	XX	XXX	X
		XX	X
		XXXX	XXXX
		XXXXXXXXXXXX	XXX
			XXXX-XXXXXXXX-XX

E167814

The transmission code is on the Safety Compliance Certification Label. The following table shows the transmission code along with the transmission description.

Description	Code
Six-speed automatic transmission 6R140	P
Six-speed automatic transmission 6R100	S
Six-speed automatic transmission 6R140W	W

# Capacities and Specifications

## CAPACITIES AND SPECIFICATIONS - 6.2L

### Capacities

#### WARNING



The air conditioning refrigerant system contains refrigerant under high pressure. Only qualified personnel should service the air conditioning refrigerant system. Opening the air conditioning refrigerant system can cause personal injury.

Item	Capacity
Engine oil (with oil filter)	7.0 qt (6.6 L)
Engine coolant	21.3 qt (20.2 L)
Brake fluid	Between MIN and MAX on brake fluid reservoir
Front axle	2.7 qt (2.6 L)
Rear axle-10.5 inch (E-Locker)	3.3–3.5 qt (3.1–3.3 L)
Rear axle-10.5 inch (non E-Locker)	3.5–3.6 qt (3.3–3.4 L)
Rear axle-Dana M300	3.78 qt (3.58 L) *
Automatic transmission fluid (6R100)	16.7 qt (15.8 L) **
Automatic transmission fluid (6R140)	17.4 qt (16.5 L) **
Transfer case fluid	1.9 qt (1.8 L)
Windshield washer fluid	Fill as required
Fuel tank (incomplete vehicle, middle location)	26.5 gal (100.3 L)
Fuel tank (All except 176 inch wheelbase and incomplete vehicles)	34.5 gal (130.6 L)
Fuel tank (176 inch wheelbase)	48.5 gal (183.6 L)
Fuel tank (incomplete vehicle, Aft- axle - location)	40 gal (151.4 L)

## Capacities and Specifications

Item	Capacity
A/C refrigerant	27 oz (0.77 kg)
A/C refrigerant compressor oil	4.1 fl oz (120 ml)

\*For complete refill of limited slip Ford axles, add 7.1 fl oz. (210 ml) of Additive Friction Modifier XL-3 or equivalent, meeting Ford Specification EST-M2C118-A. This added friction modifier should be included in the total lube volume of 3.78 qt (3.58 L).

\*\*Approximate dry fill capacity. Actual amount may vary during fluid changes.

## Specifications

### Materials

Name	Specification
Recommended motor oil (U.S.): Motorcraft® SAE 5W-30 Premium Synthetic Blend Motor Oil XO-5W30-QSP	WSS-M2C946-A
Recommended motor oil (Canada): Motorcraft® SAE 5W-30 Super Premium Motor Oil CXO-5W30-LSP12	WSS-M2C946-A
Optional motor oil (U.S.): Motorcraft® SAE 5W-30 Full Synthetic Motor Oil XO-5W30-QFS	WSS-M2C946-A
Optional motor oil (Canada): Motorcraft® SAE 5W-30 Synthetic Motor Oil CXO-5W30-LFS12	WSS-M2C946-A
Engine coolant (U.S.): Motorcraft® Orange Prediluted Antifreeze/Coolant VC-3DIL-B	WSS-M97B44-D2
Engine coolant (Canada): Motorcraft® Orange Prediluted Antifreeze/Coolant CVC-3DIL-B	WSS-M97B44-D2
Brake fluid: Motorcraft® DOT 4 Low Viscosity (LV) High Performance Motor Vehicle Brake Fluid PM-20	WSS-M6C65-A2
Front axle fluid : Motorcraft® SAE 80W-90 Premium Rear Axle Lubricant	WSP-M2C197-A

## Capacities and Specifications

Name	Specification
XY-80W90-QL	
Rear axle fluid (10.50 inch axle) (E-Locker/non E-Locker): Motorcraft® SAE 75W-85 Premium Synthetic Hypoid Gear Lubricant XY-75W85-QL	WSS-M2C942-A
Rear axle fluid (Dana M300 except 3.73 ratio Chassis Cab) (U.S.): Motorcraft® SAE 80W-90 Premium Rear Axle Lubricant XY-80W90-QL	WSP-M2C197-A
Rear axle fluid (Dana M300) (Canada): Motorcraft® SAE 80W-90 Premium Rear Axle Lubricant CXY-80W90-1L	WSP-M2C197-A
Friction Modifier Motorcraft® Additive Friction Modifier XL-3	EST-M2C118-A
Automatic transmission fluid (U.S.): Motorcraft® MERCON LV Automatic Transmission Fluid XT-10-QLVC	WSS-M2C938-A MERCON LV
Automatic transmission fluid (Canada): Motorcraft® MERCON LV Automatic Transmission Fluid CXT-10-LV12	WSS-M2C938-A MERCON LV
Transfer case fluid (U.S.): Motorcraft® Transfer Case Fluid XT-10-QLVC	WSS-M2C938-A MERCON LV
Transfer case fluid (Canada): Motorcraft® Transfer Case Fluid CXT-10-LV12	WSS-M2C938-A MERCON LV
Power steering fluid: Motorcraft® MERCON LV XT-10-QLVC	WSS-M2C938-A MERCON LV
Spindle bearing: High Temperature 4x4 Front Axle and Wheel Bearing Grease XG-11	WSS-M2C192-A
Windshield washer fluid (U.S.): Motorcraft® Premium Windshield Wash Concentrate with Bitterant ZC-32-B2	WSS-M14P19-A



## Capacities and Specifications

Name	Specification
Windshield washer fluid (Canada): Motorcraft® Premium Quality Windshield Washer Fluid CXC-37-(A, B, D, F)	WSS-M14P19-A
A/C refrigerant (U.S.): Motorcraft® R-134a Refrigerant YN-19	WSH-M17B19-A
A/C refrigerant (Canada): Motorcraft® R-134a Refrigerant CYN-16-R	WSH-M17B19-A
A/C refrigerant compressor oil: Motorcraft® PAG Refrigerant Compressor Oil YN-12-D	WSH-M1C231-B
Multi-purpose grease: Motorcraft® Multi-Purpose Grease Spray XL-5-A	ESB-M1C93-B
Lock cylinders (U.S.): Penetrating and Lock Lubricant XL-1	-
Lock cylinders (Canada): Penetrating Fluid CXC-51-A	-
Transmission, parking brake linkages and pivots, brake pedal shift: Motorcraft® Premium Long-Life Grease XG-1-E	WSD-M1C227-A

If you use oil and fluids that do not meet the defined specification and viscosity grade, this may lead to:

- Component damage which is not covered by the vehicle warranty.
- Longer engine cranking periods.
- Increased emission levels.
- Reduced engine performance.
- Reduced fuel economy.
- Degraded brake performance.

We recommend Motorcraft® motor oil for your vehicle. If Motorcraft® oil is not available, use motor oils of the recommended viscosity grade that meet API SN requirements and display the API Certification Mark for gasoline engines. Do not use oil labeled with API SN service category unless the label also displays the API certification mark.

# Capacities and Specifications



E142732

An oil that displays this symbol conforms to current engine, emission system and fuel economy performance standards of ILSAC.

Do not use supplemental engine oil additives because they are unnecessary and could lead to engine damage that may not be covered by your vehicle warranty.

**Note:** Ford recommends using DOT 4 Low Viscosity (LV) High Performance Brake Fluid or equivalent meeting WSS-M6C65-A2. Use of any fluid other than the recommended fluid may cause degraded brake performance and not meet the Ford performance standards. Keep brake fluid clean and dry. Contamination with dirt, water, petroleum products or other materials may result in brake system damage and possible failure.

**Note:** Automatic transmissions that require MERCON® LV transmission fluid should only use MERCON® LV transmission fluid. The use of any other fluid may cause transmission damage.

## Alternative Engine Oil for Extremely Cold Climates

To improve engine cold start performance, we recommend that you use the following alternative engine oil in extremely cold climates, where the ambient temperature reaches -22°F (-30°C) or below.

## Materials

Name	Specification
Motorcraft® SAE 0W-30 Premium Synthetic Blend Motor Oil: Engine Oil - SAE 0W-30 XO-0W30-QSP	WSS-M2C953-A1

# Capacities and Specifications

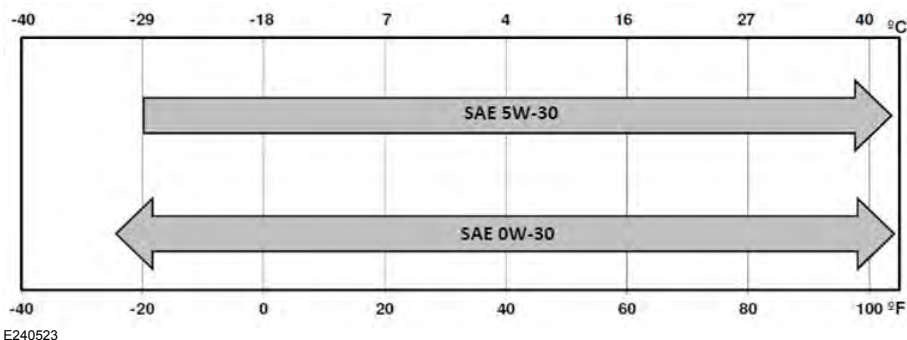

## CAPACITIES AND SPECIFICATIONS - 6.7L DIESEL

### Capacities

#### WARNING



The air conditioning refrigerant system contains refrigerant under high pressure. Only qualified personnel should service the air conditioning refrigerant system. Opening the air conditioning refrigerant system can cause personal injury.

Item	Capacity
Engine oil (includes filter change)	13.0 qt (12.3 L)
Engine coolant (primary high-temperature cooling system loop)	35.1 qt (33.2 L) <sup>1</sup>
Engine coolant additive (primary high-temperature cooling system loop)	47.3 fl oz (1.4 L) <sup>2</sup>
Engine coolant (secondary cooling system)	15.1 qt (14.3 L) <sup>1</sup>
Engine coolant additive (secondary cooling system)	16.0 fl oz (473 ml) <sup>2</sup>
Brake fluid	Between MIN and MAX on brake fluid reservoir
Front axle	2.7 qt (2.6 L)
Rear axle-10.5 inch (E-Locker)	3.3–3.5 qt (3.1–3.3 L)

## Capacities and Specifications

Item	Capacity
Rear axle-10.5 inch (non E-Locker)	3.5–3.6 qt (3.3–3.4 L)
Rear axle- Dana M275	3.61 qt (3.42 L)
Rear axle- Dana M300	3.78 qt (3.58 L) <sup>3</sup>
Automatic transmission fluid	17.4 qt (16.5 L) <sup>4,5</sup>
Transfer case fluid	1.9 qt (1.8 L)
Windshield washer fluid	Fill as required
Fuel Tank (142 inch and 148 inch wheel-base, middle location)	29.0 gal (109.8 L)
Fuel Tank (160 inch and 164 inch wheel-base, middle location)	34.0 gal (128.7 L)
Fuel Tank (176 inch wheelbase, middle location)	48 gal (181.7 L)
Fuel tank (incomplete vehicle, middle location)	106.0 qt (100.3 L)
Fuel tank (incomplete vehicle, Aft- axle - location)	40.0 gal (151.4 L)
Fuel tank (incomplete vehicle, Middle and Aft- axle -locations)	66.5 gal (251.7 L)
Diesel Exhaust Fluid (DEF) (complete vehicle)	7.4 gal (28 L)
Diesel Exhaust Fluid (DEF) (incomplete vehicle)	7.2 gal (27.3 L)
Windshield washer fluid	Fill as required

## Capacities and Specifications

Item	Capacity
A/C refrigerant	27 oz (0.77 kg)
A/C refrigerant compressor oil	3.4 fl oz (100 ml) <sup>6</sup>

<sup>1</sup>Use the coolant type originally equipped in your vehicle. Using any other coolant may result in vehicle damage.

<sup>2</sup>Per addition if required.

<sup>3</sup>For complete refill of limited slip Ford axles add 7.1 fl oz. (210 ml) of Additive Friction Modifier XL-3 or equivalent meeting Ford Specification EST-M2C118-A this added friction modifier should be included in the total lube volume 3.58 L (3.78 qt).

<sup>4</sup>Approximate dry fill capacity. Actual amount may vary during fluid changes.

<sup>5</sup>Capacities may be higher if the vehicle is equipped with a cooler. Always check to make sure the fluid level is in the acceptable range.

<sup>6</sup>This system uses mineral-based refrigerant oil to lubricate O-rings and fittings.

## Specifications

### Materials

Name	Specification
Recommended motor oil (U.S.): Motorcraft® SAE 10W-30 Super Duty Diesel Motor Oil <sup>1</sup> XO-10W30-QSD	WSS-M2C171-F1
Recommended motor oil (Canada): Motorcraft® SAE 10W-30 Super Duty Diesel Motor Oil <sup>1</sup> CXO-10W30-LSD12	WSS-M2C171-F1
Recommended motor oil (U.S.): Motorcraft® SAE 15W-40 Super Duty Diesel Motor Oil <sup>1,3</sup> XO-15W40-QSD	WSS-M2C171-F1
Recommended motor oil (Canada): Motorcraft® SAE 15W-40 Super Duty Diesel Motor Oil <sup>1,3</sup> CXO-15W40-LSD12	WSS-M2C171-F1
Recommended motor oil (U.S.): Motorcraft® SAE 5W-40 Full Synthetic Diesel Motor Oil <sup>1,2,3</sup> XO-5W40-5QSD	WSS-M2C171-F1
Recommended motor oil (U.S.):	WSS-M2C171-F1

## Capacities and Specifications

Name	Specification
Motorcraft® SAE 0W-40 Full Synthetic Diesel Motor Oil <sup>1</sup> XO-0W40-DAS	
Engine and secondary cooling system coolant (U.S.): Motorcraft® Orange Prediluted Antifreeze/Coolant VC-3DIL-B	WSS-M97B44-D2
Engine and secondary cooling system coolant (Canada): Motorcraft® Orange Prediluted Antifreeze/Coolant CVC-3DIL-B	WSS-M97B44-D2
Engine and secondary cooling system coolant additive (U.S. and Canada): Motorcraft® Specialty Orange Engine Coolant Revitalizer VC-12	--
Diesel Exhaust Fluid (DEF): Motorcraft® Diesel Exhaust Fluid PM-27-Gal / PM-27-Jug	WSS-M99C130-A
Cetane Booster & Performance Improver (U.S.): Motorcraft® Cetane Booster & Performance Improver PM-22-A	--
Cetane Booster & Performance Improver (Canada): Motorcraft® Cetane Booster & Performance Improver PM-22-B	--
Anti-Gel & Performance Improver (U.S.): Motorcraft® Anti-Gel & Performance Improver PM-23-A	--
Anti-Gel & Performance Improver (Canada): Motorcraft® Anti-Gel & Performance Improver PM-23-B	--
Brake fluid: Motorcraft® DOT 4 Low Viscosity (LV) High Performance Motor Vehicle Brake Fluid PM-20	WSS-M6C65-A2
Front axle fluid : Motorcraft® SAE 80W-90 Premium Rear Axle Lubricant XY-80W90-QL	WSP-M2C197-A
Rear axle fluid (10.50 inch axle) (E-Locker/non E-Locker): Motorcraft® SAE 75W-85 Premium Synthetic Hypoid Gear Lubricant	WSS-M2C942-A

## Capacities and Specifications

Name	Specification
XY-75W85-QL	
Rear axle fluid (Dana M275) (U.S.): Motorcraft® SAE 75W-140 Synthetic Rear Axle Lubricant XY-75W140-QL	WSL-M2C192-A
Rear axle fluid (Dana M275) (Canada): Motorcraft® SAE 75W-140 Synthetic Rear Axle Lubricant CXY-75W140-IL	WSL-M2C192-A
Rear axle fluid (Dana M300) (U.S.): Motorcraft® SAE 75W-140 Synthetic Rear Axle Lubricant XY-80W90-QL	WSL-M2C192-A
Rear axle fluid (Dana M300) (Canada) : Motorcraft® SAE 75W-140 Synthetic Rear Axle Lubricant CXY-80W90-IL	WSL-M2C192-A
Friction Modifier Motorcraft® Additive Friction Modifier XL-3	EST-M2C118-A
Automatic transmission fluid (U.S.): Motorcraft® MERCON LV Automatic Transmission Fluid XT-10-QLVC	WSS-M2C938-A MERCON LV
Automatic transmission fluid (Canada): Motorcraft® MERCON LV Automatic Transmission Fluid CXT-10-QLVC	WSS-M2C938-A MERCON LV
Windshield washer fluid (U.S.): Motorcraft® Premium Windshield Wash Concentrate with Bitterant ZC-32-B2	WSB-M8B16-A2
Transfer case fluid (U.S.): Motorcraft® Transfer Case Fluid XT-10-QLVC	WSS-M2C938-A MERCON LV
Transfer case fluid (Canada): Motorcraft® Transfer Case Fluid CXT-10-LV12	WSS-M2C938-A MERCON LV
Power steering fluid: Motorcraft® MERCON LV XT-10-QLVC	WSS-M2C938-A MERCON LV
Spindle bearing:	WSS-M2C192-A

## Capacities and Specifications

Name	Specification
High Temperature 4x4 Front Axle and Wheel Bearing Grease XG-11	
Windshield washer fluid (U.S.): Motorcraft® Premium Windshield Wash Concentrate with Bitterant ZC-32-B2	WSS-M14P19-A
Windshield washer fluid (Canada): Motorcraft® Premium Quality Windshield Washer Fluid CXC-37-(A, B, D, F)	WSS-M14P19-A
A/C refrigerant (U.S.): Motorcraft® R-134a Refrigerant YN-19	WSH-M17B19-A
A/C refrigerant (Canada): Motorcraft® R-134a Refrigerant CYN-16-R	WSH-M17B19-A
A/C refrigerant compressor oil: Motorcraft® PAG Refrigerant Compressor Oil YN-12-D	WSH-M1C231-B
Multi-purpose grease: Motorcraft® Multi-Purpose Grease Spray XL-5-A	ESB-M1C93-B
Lock cylinders (U.S.): Penetrating and Lock Lubricant XL-1	--
Lock cylinders (Canada): Penetrating Fluid CXC-51-A	--
Transmission, parking brake linkages and pivots, brake pedal shift: Motorcraft® Premium Long-Life Grease XG-1-E	WSD-M1C227-A

<sup>1</sup>See the SAE viscosities grades chart for correct temperature usage.

<sup>2</sup>For severe duty service, use SAE 5W-40 oil that meets Ford specification WSS-M2C171-F1.

<sup>3</sup>For biodiesel fuel blends (B20 max), use SAE 5W-40 or SAE 15W-40 oil that meets Ford specification WSS-M2C171-F1.



# Capacities and Specifications

If you use oil and fluids that do not meet the defined specification and viscosity grade, this may lead to:

- Component damage which is not covered by the vehicle warranty.
- Longer engine cranking periods.
- Increased emission levels.
- Reduced engine performance.
- Reduced fuel economy.
- Degraded brake performance.

**Note:** An engine block heater is recommended at temperatures below  $-10^{\circ}\text{F}$  ( $-23^{\circ}\text{C}$ ).

## Engine Oil Specifications

The use of correct oil viscosities for diesel engines is important for satisfactory operation. Determine which oil viscosity best suits the temperature range you expect to encounter for the next service interval from the following SAE viscosity grade chart.

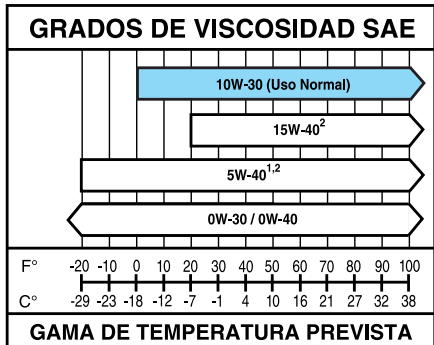
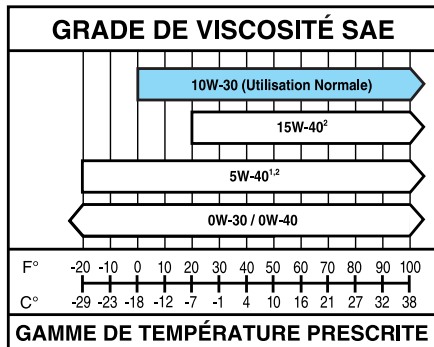
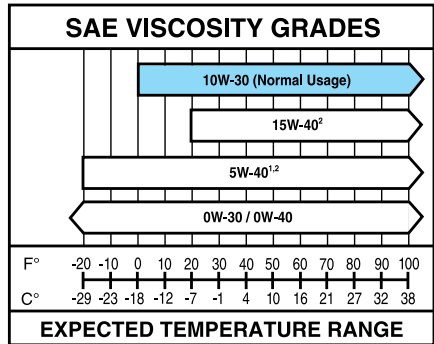

E163370

# Capacities and Specifications

**Note:** Ford recommends using DOT 4 Low Viscosity (LV) High Performance Brake Fluid or equivalent meeting WSS-M6C65-A2. Use of any fluid other than the recommended fluid may cause degraded brake performance and not meet the Ford performance standards. Keep brake fluid clean and dry. Contamination with dirt, water, petroleum products or other materials may result in brake system damage and possible failure.

## CAPACITIES AND SPECIFICATIONS - 6.8L

### Capacities

#### WARNING



The air conditioning refrigerant system contains refrigerant under high pressure. Only qualified personnel should service the air conditioning refrigerant system. Opening the air conditioning refrigerant system can cause personal injury.

Item	Capacity
Engine oil (with oil filter)	7.0 qt (6.6 L)
Engine coolant	26.7 qt (25.3 L)
Brake fluid	Between MIN and MAX on brake fluid reservoir
Front axle	2.7 qt (2.6 L)
Rear axle-10.5 inch (E-Locker)	3.3–3.5 qt (3.1–3.3 L)
Rear axle-10.5 inch (non E-Locker)	3.5–3.6 qt (3.3–3.4 L)
Rear axle-Dana M300	3.78 qt (3.58 L) <sup>1</sup>
Automatic transmission fluid	17.4 qt (16.5 L) <sup>2</sup>
Transfer case fluid	1.9 qt (1.8 L)
Windshield washer fluid	Fill as required
Fuel tank (incomplete vehicle, middle location)	26.5 gal (100.3 L)

# Capacities and Specifications

Item	Capacity
Fuel tank (incomplete vehicle, Aft- axle - location)	40 gal (151.4 L)
A/C refrigerant	27 oz (0.77 kg)
A/C refrigerant compressor oil	4.1 fl oz (120 ml)

<sup>1</sup>For complete refill of limited slip Ford axles, add 7.1 fl oz. (210 ml) of Additive Friction Modifier XL-3 or equivalent, meeting Ford Specification EST-M2C118-A. This added friction modifier should be included in the total lube volume of 3.78 qt (3.58 L).

<sup>2</sup>Approximate dry fill capacity. Actual amount may vary during fluid changes.

## Specifications

### Materials

Name	Specification
Recommended motor oil (U.S.): Motorcraft® SAE 5W-20 Premium Synthetic Blend Motor Oil XO-5W20-QSP	WSS-M2C945-A
Recommended motor oil (Canada): Motorcraft® SAE 5W-20 Super Premium Motor Oil CXO-5W20-LSP12	WSS-M2C945-A
Optional motor oil (U.S.): Motorcraft® SAE 5W-30 Premium Synthetic Blend Motor Oil XO-5W30-QSP	WSS-M2C946-A
Optional motor oil (Canada): Motorcraft® SAE 5W-30 Super Premium Motor Oil CXO-5W30-LSP12	WSS-M2C946-A
Optional motor oil (U.S.): Motorcraft® SAE 5W-30 Full Synthetic Motor Oil XO-5W30-QFS	WSS-M2C946-A
Optional motor oil (Canada): Motorcraft® SAE 5W-30 Synthetic Motor Oil CXO-5W30-LFS12	WSS-M2C946-A
Engine coolant (U.S.): Motorcraft® Orange Prediluted Antifreeze/Coolant VC-3DIL-B	WSS-M97B44-D2

## Capacities and Specifications

Name	Specification
Engine coolant (Canada): Motorcraft® Orange Prediluted Antifreeze/Coolant CVC-3DIL-B	WSS-M97B44-D2
Brake fluid: Motorcraft® DOT 4 Low Viscosity (LV) High Performance Motor Vehicle Brake Fluid PM-20	WSS-M6C65-A2
Front axle fluid : Motorcraft® SAE 80W-90 Premium Rear Axle Lubricant XY-80W90-QL	WSP-M2C197-A
Rear axle fluid (10.50 inch axle) (E-Locker/non E-Locker): Motorcraft® SAE 75W-85 Premium Synthetic Hypoid Gear Lubricant XY-75W85-QL	WSS-M2C942-A
Rear axle fluid (Dana M300 With HD Tow Option) (U.S.): Motorcraft® SAE 75W-140 Synthetic Rear Axle Lubricant XY-75W140-Q	WSL-M2C192-A
Rear axle fluid (Dana M300) (U.S.): Motorcraft® SAE 80W-90 Premium Rear Axle Lubricant XY-80W90-QL	WSP-M2C197-A
Rear axle fluid (Dana M300) (Canada): Motorcraft® SAE 80W-90 Premium Rear Axle Lubricant CXY-80W90-1L	WSP-M2C197-A
Friction Modifier Motorcraft® Additive Friction Modifier XL-3	EST-M2C118-A
Automatic transmission fluid (U.S.) : Motorcraft® MERCON LV Automatic Transmission Fluid XT-10-QLVC	WSS-M2C938-A MERCON LV
Automatic transmission fluid (Canada): Motorcraft® MERCON LV Automatic Transmission Fluid CXT-10-LV12	WSS-M2C938-A MERCON LV
Transfer case fluid (U.S.): Motorcraft® Transfer Case Fluid XT-10-QLVC	WSS-M2C938-A MERCON LV
Transfer case fluid (Canada): Motorcraft® Transfer Case Fluid CXT-10-LV12	WSS-M2C938-A MERCON LV

## Capacities and Specifications

Name	Specification
Power steering fluid: Motorcraft® MERCON LV XT-10-QLVC	WSS-M2C938-A MERCON LV
Spindle bearing: High Temperature 4x4 Front Axle and Wheel Bearing Grease XG-11	WSS-M2C192-A
Windshield washer fluid (U.S.): Motorcraft® Premium Windshield Wash Concentrate with Bitterant ZC-32-B2	WSS-M14P19-A
Windshield washer fluid (Canada): Motorcraft® Premium Quality Windshield Washer Fluid CXC-37-(A, B, D, F)	WSS-M14P19-A
A/C refrigerant (U.S.): Motorcraft® R-134a Refrigerant YN-19	WSH-M17B19-A
A/C refrigerant (Canada): Motorcraft® R-134a Refrigerant CYN-16-R	WSH-M17B19-A
A/C refrigerant compressor oil: Motorcraft® PAG Refrigerant Compressor Oil YN-12-D	WSH-M1C231-B
Multi-purpose grease: Motorcraft® Multi-Purpose Grease Spray XL-5-A	ESB-M1C93-B
Lock cylinders (U.S.): Penetrating and Lock Lubricant XL-1	-
Lock cylinders (Canada): Penetrating Fluid CXC-51-A	-
Transmission, parking brake linkages and pivots, brake pedal shift: Motorcraft® Premium Long-Life Grease XG-1-E	WSD-M1C227-A

# Capacities and Specifications

If you use oil and fluids that do not meet the defined specification and viscosity grade, this may lead to:

- Component damage which is not covered by the vehicle warranty.
- Longer engine cranking periods.
- Increased emission levels.
- Reduced engine performance.
- Reduced fuel economy.
- Degraded brake performance.

We recommend Motorcraft® motor oil for your vehicle. If Motorcraft® oil is not available, use motor oils of the recommended viscosity grade that meet API SN requirements and display the API Certification Mark for gasoline engines. Do not use oil labeled with API SN service category unless the label also displays the API certification mark.



E142732

## Materials

Name	Specification
Motorcraft® SAE 0W-20 Premium Synthetic Blend Motor Oil: Engine Oil - SAE 0W-20 XO-0W20-QSP	WSS-M2C947-A

An oil that displays this symbol conforms to current engine, emission system and fuel economy performance standards of ILSAC.

Do not use supplemental engine oil additives because they are unnecessary and could lead to engine damage that may not be covered by your vehicle warranty.

**Note:** *Ford recommends using DOT 4 Low Viscosity (LV) High Performance Brake Fluid or equivalent meeting WSS-M6C65-A2. Use of any fluid other than the recommended fluid may cause degraded brake performance and not meet the Ford performance standards. Keep brake fluid clean and dry. Contamination with dirt, water, petroleum products or other materials may result in brake system damage and possible failure.*

**Note:** *Automatic transmissions that require MERCON® LV transmission fluid should only use MERCON® LV transmission fluid. The use of any other fluid may cause transmission damage.*

## Alternative Engine Oil for Extremely Cold Climates

To improve engine cold start performance, we recommend that you use the following alternative engine oil in extremely cold climates, where the ambient temperature reaches -22°F (-30°C) or below.

# Capacities and Specifications

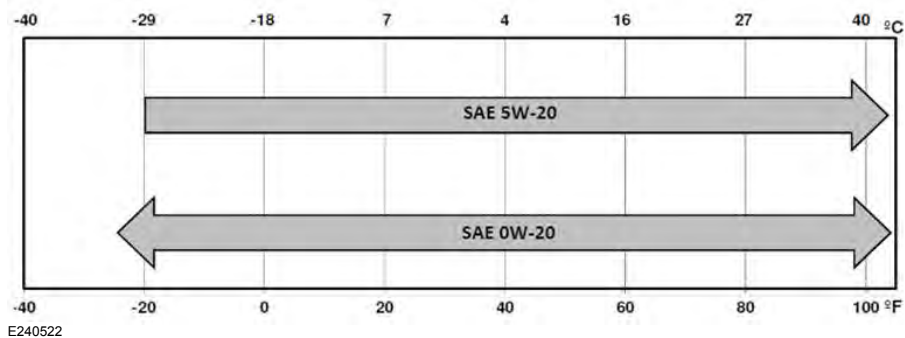

# Audio System

## GENERAL INFORMATION

### Radio Frequencies and Reception Factors

AM and FM frequencies are established by the Federal Communications Commission (FCC) and the Canadian Radio and Telecommunications Commission (CRTC). Those frequencies are:

- AM: 530-1710 kHz
- FM: 87.9-107.9 MHz

**Note:** *Listening to loud audio for long periods of time could damage your hearing.*

Radio Reception Factors	
<b>Distance and strength</b>	The further you travel from an AM or FM station, the weaker the signal and the weaker the reception.
<b>Terrain</b>	Hills, mountains, tall buildings, bridges, tunnels, freeway overpasses, parking garages, dense tree foliage and thunderstorms can interfere with the reception.
<b>Station overload</b>	When you pass a ground-based broadcast repeating tower, a stronger signal may overtake a weaker one and result in the audio system muting.

### CD and CD Player Information

**Note:** *CD units play commercially pressed 4.7 in (12 cm) audio compact discs only. Due to technical incompatibility, certain recordable and re-recordable compact discs may not function correctly when used in Ford CD players.*

**Note:** *Do not insert CDs with homemade paper (adhesive) labels into the CD player as the label may peel and cause the CD to become jammed. You should use a permanent felt tip marker rather than adhesive labels on your homemade CDs. Ballpoint pens may damage CDs. Ask an authorized dealer for more information.*

**Note:** *Do not use any irregularly shaped discs or discs with a scratch protection film attached.*

Always handle discs by their edges only. Clean the disc with an approved CD cleaner only. Wipe it from the center of the disc toward the edge. Do not clean in a circular motion.

Do not expose discs to direct sunlight or heat sources for extended periods.



# Audio System

---

## MP3 and WMA Track and Folder Structure

Audio systems capable of recognizing and playing MP3 and WMA individual tracks and folder structures work as follows:

- There are two different modes for MP3 and WMA disc playback: MP3 and WMA track mode (system default) and MP3 and WMA folder mode.
- MP3 and WMA track mode ignores any folder structure on the MP3 and WMA disc. The player numbers each MP3 and WMA track on the disc (noted by the MP3 or WMA file extension) from T001 to a maximum of T255. The maximum number of playable MP3 and WMA files may be less depending on the structure of the CD and exact model of radio present.
- MP3 and WMA folder mode represents a folder structure consisting of one level of folders. The CD player numbers all MP3 and WMA tracks on the disc (noted by the MP3 or WMA file extension) and all folders containing MP3 and WMA files, from F001 (folder) T001 (track) to F253 T255.
- Creating discs with only one level of folders helps with navigation through the disc files.

If you are burning your own MP3 and WMA discs, it is important to understand how the system reads the structures you create. While various files may be present (files with extensions other than MP3 and WMA), only files with the MP3 and WMA extension are played; other files are ignored by the system. This enables you to use the same MP3 and WMA disc for a variety of tasks on your work computer, home computer and your in-vehicle system.

In track mode, the system displays and plays the structure as if it were only one level deep (all MP3 and WMA files play, regardless of being in a specific folder). In folder mode, the system only plays the MP3 and WMA files in the current folder.

## AUDIO UNIT - VEHICLES WITH: AM/FM

### WARNING



Driving while distracted can result in loss of vehicle control, crash and injury. We strongly recommend that you use extreme caution when using any device that may take your focus off the road. Your primary responsibility is the safe operation of your vehicle. We recommend against the use of any hand-held device while driving and encourage the use of voice-operated systems when possible. Make sure you are aware of all applicable local laws that may affect the use of electronic devices while driving.

---

# Audio System



E235504

**A SOURCE:** Press to access different audio modes, for example AM, FM.

**B AUX:** Press to access the AUX and SYNC features, it also cancels the menu or list browsing.

**C CLOCK:** Press to display the clock.

**D TUNE:** In radio mode, turn to search through the radio frequency band. In SIRIUS mode, turn to find the previous or next available satellite radio station.

**E Seek, Fast Forward and Reverse:** In radio mode, select a frequency band and press either button. The system stops at the first station it finds in that direction. In SIRIUS mode, press to select the next or previous satellite radio station. If you

select a specific category (such as jazz, rock or news), press to find the next or previous station in the selected category. In CD mode, press to select the next or previous track. Press and hold to move quickly forward or backward through the current track.

**F MENU:** Press to access different audio system features.

**G Memory presets:** Store your favorite radio stations. To store a radio station, tune to the station, then press and hold a preset button until sound returns.

**H Vol and Power:** Turn to adjust the volume. Press to switch the system on and off.

# Audio System

## AUDIO UNIT - VEHICLES WITH: AM/FM/CD/SYNC

### WARNING



Driving while distracted can result in loss of vehicle control, crash and injury. We strongly recommend that you use extreme caution when using any device that may take your focus off the road. Your primary responsibility is the safe operation of your vehicle. We recommend against the use of any hand-held device while driving and encourage the use of voice-operated systems when possible. Make sure you are aware of all applicable local laws that may affect the use of electronic devices while driving.

**Note:** Some features, such as SIRIUS satellite radio, may not be available in your location. Check with an authorized dealer.

**Note:** Depending on your vehicle option package, your system may look different from what you see here.

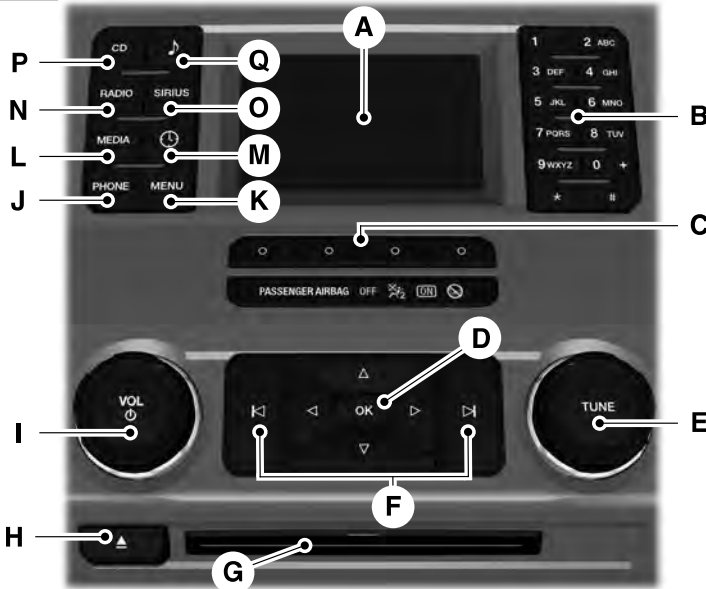

E217906

# Audio System

---

- A Display screen:** Shows audio and SYNC information.
- B Number block:** In radio mode, store and recall your favorite radio stations. To store a radio station, tune to the station, then press and hold a preset button until sound returns. In CD mode, select a track. In phone mode, enter a phone number.
- C Function buttons:** Select different functions of the audio system depending on which mode you are in (such as Radio mode or CD mode).
- D OK and cursor arrows:** Press the up and down arrow buttons to select the various settings. When you make your selection, press the left and right arrow buttons to change the settings. Press **OK** to set, or press **MENU** to exit.
- E TUNE:** In radio mode, turn to search through the radio frequency band. In SIRIUS mode, turn to find the previous or next available satellite radio station.
- F Seek, Fast Forward and Reverse:** In radio mode, select a frequency band and press either button. The system stops at the first station it finds in that direction. In SIRIUS mode, press to select the next or previous satellite radio station. If you select a specific category (such as jazz, rock or news), press to find the next or previous station in the category you select. In CD mode, press to select the next or previous track. Press and hold to move quickly forward or backward through the current track.
- G CD slot:** Insert a CD.
- H Eject:** Press to eject a CD.
- I Vol and Power:** Turn to adjust the volume. Press to switch the system on and off.
- J PHONE:** Press to access the phone features of the SYNC system. See your SYNC information.
- K MENU:** Press to access different audio system features. See **Menu Structure**.
- L MEDIA:** Press to open the media source menu. You can press this multiple times to change to CD or to a SYNC-Media device or scroll through the media sources using the arrow buttons. Press **OK** to select a source.
- M Clock:** Press to access the clock setting. Use the center arrow controls to change the hours and minutes. You can also set the clock by pressing **MENU** and scrolling to Clock Settings. If not in phone mode, press to display the clock.
- N RADIO:** Press to listen to the radio or change radio stations. Press the function buttons below the radio screen to select different radio functions.
- O SIRIUS:** Press to listen to SIRIUS satellite radio.

# Audio System

**P CD:** Press to listen to a CD. Press the function buttons below the radio screen to select on-screen options of Repeat or Shuffle.

**Q SOUND:** Press to access settings for Treble, Midrange, Bass, Fade and Balance. Use the up and down arrow buttons to select the various settings. When you make your selection, press the left and right arrow buttons to change the settings. Press **OK** to set or press **MENU** to exit. Sound settings can be set for each audio source independently.

## Menu Structure

**Note:** *Depending on your system, some options may appear slightly different.*

Press **MENU**.

Press the up and down arrow buttons to scroll through the options.

Press the right arrow to enter a menu.  
Press the left arrow to exit a menu.

Press **OK** to confirm a selection.

Radio	
Manual Tune	Use the left and right arrows to go up or down the frequency band.
Scan	Select for a brief sampling of all available channels.
AST	Select to store the six strongest local stations on the AM-AST and FM-AST frequency bands.
Set Category for Seek/Scan	Select to have the system search by certain music categories (such as Rock, Pop or Country).
RDS Text Display	Select to view additional broadcast data, if available. This feature defaults to off. RBDS must be on for you to set a category.

# Audio System

<b>SIRIUS</b>	
Scan	Select for a brief sampling of all available channels.
Electronic Serial Number (ESN)	Select to view your satellite radio electronic serial number (ESN). You will need this number when communicating with SIRIUS to activate, modify or track your account.
Check Channel Guide	Select to view available satellite radio channels. Press <b>OK</b> to open a list of the following options for this channel. Once you skip or lock a channel, you can only access it by pressing <b>Direct Tune</b> and entering the channel number. Locking or unlocking a channel requires your PIN.
Set Category for Seek/Scan	Select to view channel categories (such as Pop, Rock or News). If you select a category, seek and scan functions only stop on channels in that category.
Alerts	Select to switch alerts on or off for songs, artists or teams. The system alerts you when the selection is playing on another channel. Save up to 20 alerts.
Unlock All Stations	Use your PIN to unlock previously locked stations.
Skip No Stations	Use to restore any channels you previously skipped.
Parental Lockout	Select to create a PIN, which allows you to lock or unlock channels. Your initial PIN is 1234.

<b>Audio Settings</b>	
Speed Compensated Volume	Adjusts the volume to compensate for speed and wind noise. You can set the system between 0 and +7.
Sound	Select to adjust settings for Treble, Midrange, Bass, Fade or Balance.
Occupancy Mode	Select to optimize sound quality for the chosen seating position.
DSP	Choose between the stereo modes.

# Audio System

---

<b>CD Settings</b>	
Scan All	Select to scan all disc selections.
Scan Folder	Select to scan all music in the current MP3 folder.
CD Compression	Select to bring soft and loud passages together for a more consistent listening level.

<b>Clock Settings</b>	
Set Date and Time	Select to set the time and calendar date.
24 Hour	Select to view clock time in a 12-hour mode or 24-hour mode.

<b>Display Settings</b>	
Brightness	Select to change display brightness.
Language	Select to display the language in English, French or Spanish.
Temp. Setting	Select to display the outside temperature in Fahrenheit or Celsius.

# Audio System

## AUDIO UNIT - VEHICLES WITH: AM/FM/CD/TOUCHSCREEN DISPLAY

### WARNING



Driving while distracted can result in loss of vehicle control, crash and injury. We strongly recommend that you use extreme caution when using any device that may take your focus off the road. Your primary responsibility is the safe operation of your vehicle. We recommend against the use of any hand-held device while driving and encourage the use of voice-operated systems when possible. Make sure you are aware of all applicable local laws that may affect the use of electronic devices while driving.

**Note:** Some features, such as SIRIUS satellite radio, may not be available in your location. Check with an authorized dealer.

**Note:** The touchscreen system controls most of the audio features. See your SYNC information.

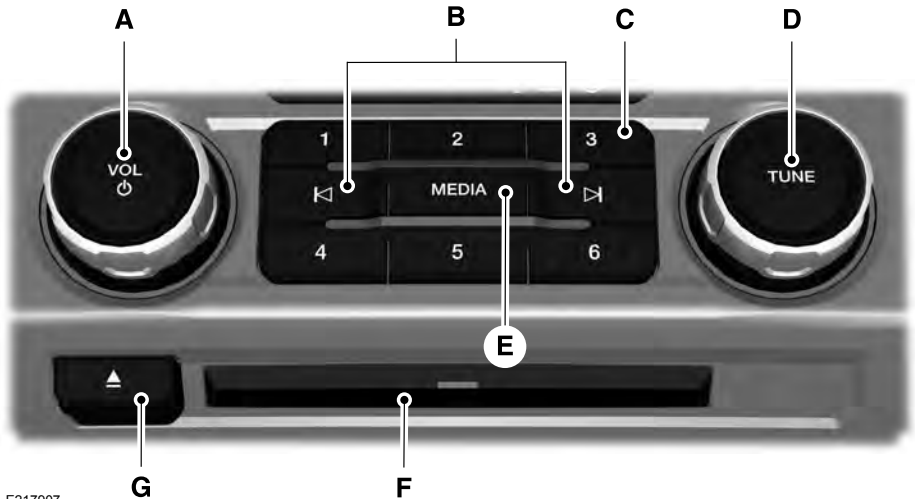

E217907



# Audio System

---

- A **Vol and Power:** Turn to adjust the volume. Press to switch the system on and off.
- B **Seek, Fast Forward and Reverse:** In radio mode, select a frequency band and press either button. The system stops at the first station it finds in that direction. In SIRIUS mode, press to select the next or previous satellite radio station. If you select a specific category (such as jazz, rock or news), press to find the next or previous station in the category you select. In CD mode, press to select the next or previous track. Press and hold to move quickly forward or backward through the current track.
- C **Memory presets:** Store your favorite radio stations. To store a radio station, tune to the station, then press and hold a preset button until sound returns.
- D **TUNE:** In radio mode, turn to search through the radio frequency band. In SIRIUS mode, turn to find the previous or next available satellite radio station.
- E **MEDIA:** Press to access different audio modes, such as AM, FM.
- F **CD slot:** Insert a CD.
- G **Eject:** Press to eject a CD.

HD Radio technology is the digital evolution of analog AM/FM radio. Your system has a special receiver that allows it to receive digital broadcasts (where available) in addition to the analog broadcasts, it already receives. Digital broadcasts provide a better sound quality than analog broadcasts with free, crystal-clear audio and no static or distortion. For more information, and a guide to available stations and programming, please visit [www.hdradio.com](http://www.hdradio.com).

When HD Radio is on and you tune to a station broadcasting HD Radio technology, you may notice the HD Radio logo on your screen. When this logo is available, you may also see Title and Artist fields on-screen.

The multicast indicator appears in FM mode (only) if the current station is broadcasting multiple digital broadcasts. The highlighted numbers signify available digital channels where new or different content is available. HD1 signifies the main programming status and is available in analog and digital broadcasts. Other multicast stations (HD2 through HD7) are only available digitally.

## DIGITAL RADIO

**Note:** *HD Radio broadcasts are not available in all markets.*

# Audio System

When HD Radio broadcasts are active, you can access the following functions:

- **Scan** allows you to hear a brief sampling of all available stations. This feature still works when HD Radio reception is on, although it does not scan for HD2-HD7 channels. You may see the HD logo appear if the station has a digital broadcast.

- **Memory presets** allow you to save an active channel as a memory preset. Touch and hold a memory preset slot until the sound returns. There is a brief mute while the radio saves the station. Sound returns when finished. When switching to an HD2 or HD3 memory preset, the sound mutes before the digital audio plays, because the system has to reacquire the digital signal.

**Note:** *As with any saved radio station, you cannot access a station you save if your vehicle is outside the station's reception area.*

## HD Radio Reception and Station Troubleshooting

Potential Reception Issues	
Reception area	If you are listening to a multicast station and you are on the fringe of the reception area, the station may mute due to weak signal strength.
	If you are listening to HD1, the system switches back to the analog broadcast until the digital broadcast is available again. However, if you are listening to any of the possible HD2-HD7 multicast channels, the station mutes and stays muted unless it is able to connect to the digital signal again.
Station blending	When the system first receives a station (aside from HD2-HD7 multicast stations), it first plays the station in the analog version. Once the receiver verifies the station is an HD Radio station, it shifts to the digital version. Depending on the station quality, you may hear a slight sound change when the station changes from analog to digital. Blending is the shift from analog to digital sound or digital back to analog sound.

In order to provide the best possible experience, use the contact form to report any station issues found while listening to a station broadcasting with HD Radio technology. Independent entities own and operate each station. These stations are responsible for ensuring all audio streams and data fields are accurate.

# Audio System

Potential Station Issues		
Issues	Cause	Action
Echo, stutter, skip or repeat in audio. Increase or decrease in audio volume.	This is poor time alignment by the radio broadcaster.	No action required. This is a broadcast issue.
Sound fading or blending in and out.	The radio is shifting between analog and digital audio.	No action required. The reception issue may clear up as you continue to drive.
There is an audio mute delay when selecting HD2 or HD3, multicast preset or <b>Direct Tune</b> .	The digital multicast is not available until the HD Radio broadcast is decoded. Once decoded, the audio is available.	No action required. This is normal behavior. Wait until the audio is available.
Cannot access HD2 or HD3 multicast channel when recalling a preset or from a direct tune.	The previously stored multicast preset or direct tune is not available in your current reception area.	No action required. The station is not available in your current location.
Text information does not match currently playing audio.	Data service issue by the radio broadcaster.	Fill out the station issue form at website listed below.*
There is no text information shown for currently selected frequency.	Data service issue by the radio broadcaster.	Fill out the station issue form at website listed below.*
HD2-HD7 stations not found when <b>Scan</b> is pressed.	Pressing <b>Scan</b> disables HD2-HD7 channel search.	No action required. This is normal behavior.

\*<http://hdradio.com/stations/feedback>

HD Radio Technology manufactured under license from iBiquity Digital Corporation and foreign patents. HD Radio and the HD and HD Radio logos are proprietary trademarks of DTS Ford Motor Company and DTS are not responsible for the content sent using HD Radio technology. Content may be changed, added or deleted at any time at the station owner's discretion.

## SATELLITE RADIO (If Equipped)

SiriusXM® broadcasts a variety of music, news, sports, weather, traffic and entertainment satellite radio channels. For more information and a complete list of SiriusXM satellite radio channels, visit [www.siriusxm.com](http://www.siriusxm.com) in the United States, [www.siriusxm.ca](http://www.siriusxm.ca) in Canada, or call SiriusXM at 1-888-539-7474.

# Audio System

**Note:** This receiver includes the eCos real-time operating system. eCos is published under the eCos License.

## Satellite Radio Reception Factors

Potential satellite radio reception issues	
Antenna obstructions	For optimal reception performance, keep the antenna clear of snow and ice build-up and keep luggage and other material as far away from the antenna as possible.
Terrain	Hills, mountains, tall buildings, bridges, tunnels, freeway overpasses, parking garages, dense tree foliage and thunderstorms can interfere with your reception.
Station overload	When you pass a ground-based broadcast-repeating tower, a stronger signal may overtake a weaker one and the audio system may mute.
Satellite radio signal interference	Your display may show ACQUIRING . . . to indicate the interference and the audio system may mute.

## SiriusXM Satellite Radio Service

**Note:** *SiriusXM reserves the unrestricted right to change, rearrange, add or delete programming including canceling, moving or adding particular channels, and its prices, at any time, with or without notice to you. Ford Motor Company shall not be responsible for any such programming changes.*



E208625

SiriusXM satellite radio is a subscription-based satellite radio service that broadcasts a variety of music, sports, news, weather, traffic and entertainment programming. Your factory-installed SiriusXM satellite radio system includes hardware and a limited subscription term, which begins on the date of sale or lease of your vehicle. See an authorized dealer for availability.

For more information on extended subscription terms (a service fee is required), the online media player and a complete list of SiriusXM satellite radio channels, and other features, please visit [www.siriusxm.com](http://www.siriusxm.com) in the United States, [www.siriusxm.ca](http://www.siriusxm.ca) in Canada, or call SiriusXM at 1-888-539-7474.

## Satellite Radio Electronic Serial Number (ESN)

You need your ESN to activate, modify or track your satellite radio account. When in satellite radio mode, tune to channel 0.

# Audio System

## Troubleshooting

Message	Condition	Action
Acquiring...	Radio requires more than two seconds to produce audio for the selected channel.	No action required. This message should disappear shortly.
Satellite antenna fault SIRIUS system failure	There is an internal module or system failure present.	If this message does not clear shortly, or with an ignition key cycle, your receiver may have a fault. See an authorized dealer for service.
Invalid Channel	The channel is no longer available.	Tune to another channel or choose another preset.
Unsubscribed Channel	Your subscription does not include this channel.	Contact SiriusXM at 1-888-539-7474 to subscribe to the channel, or tune to another channel.
No Signal	The signal is lost from the SiriusXM satellite or SiriusXM tower to your vehicle antenna.	The signal is blocked. When you move into an open area, the signal should return.
Updating...	Update of channel programming in progress.	No action required. The process may take up to three minutes.
Questions? Call 1-888-539-7474	Your satellite service is no longer available.	Contact SiriusXM at 1-888-539-7474 to resolve subscription issues.
None found Check Channel Guide	All the channels in the selected category are either skipped or locked.	Use the channel guide to turn off the Lock or Skip function on that station.
Subscription Updated	SiriusXM has updated the channels available for your vehicle.	No action required.

# Audio System

---

## USB PORT

### WARNING



Driving while distracted can result in loss of vehicle control, crash and injury. We strongly recommend that you use extreme caution when using any device that may take your focus off the road. Your primary responsibility is the safe operation of your vehicle. We recommend against the use of any hand-held device while driving and encourage the use of voice-operated systems when possible. Make sure you are aware of all applicable local laws that may affect the use of electronic devices while driving.

---



E205592

**Note:** *The rear console USB ports are for charging only. See **Center Console** (page 172).*

The USB port allows you to plug in media playing devices, memory sticks and charge devices (if supported). See your SYNC information.

## GENERAL INFORMATION

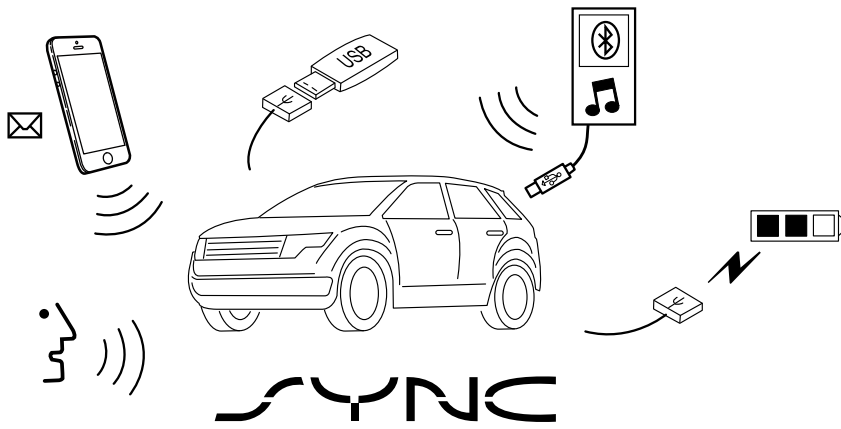

E198355

SYNC is an in-vehicle communications system that works with your Bluetooth-enabled cellular phone and portable media player. This allows you to:

- Make and receive calls.
- Access and play music from your portable music player.
- Use 911 Assist and applications, such as Spotify and Glympse, via SYNC AppLink.
- Access phonebook contacts and music using voice commands.
- Stream music from your connected phone.
- Text message.

- Use the advanced voice recognition system.
- Charge your USB device (if your device supports this).

\*These features are not available in all markets and may require activation. Available AppLink enabled apps vary by market.

Make sure that you review your device's manual before using it with SYNC.

### Support

The SYNC support team is available to help you with any questions you cannot answer on your own.

Monday-Saturday, 8:30am-9:00pm EST.

Sunday, 10:30am-7:30pm EST.

In the United States, call 1-800-392-3673.

In Canada, call 1-800-565-3673.

Times are subject to change due to holidays.

## SYNC Owner Account

Why do I need a SYNC owner account?

- Essential for keeping up with the latest software downloads available for SYNC.
- Access to customer support for any questions you may have.

## Driving Restrictions

For your safety, certain features are speed-dependent and restricted when your vehicle is traveling over 3 mph (5 km/h).

## Safety Information

### WARNING



Driving while distracted can result in loss of vehicle control, crash and injury. We strongly recommend that you use extreme caution when using any device that may take your focus off the road. Your primary responsibility is the safe operation of your vehicle. We recommend against the use of any hand-held device while driving and encourage the use of voice-operated systems when possible. Make sure you are aware of all applicable local laws that may affect the use of electronic devices while driving.

---

When using SYNC:

- Do not operate playing devices if the power cords or cables are broken, split or damaged. Place cords and cables out of the way, so they do not interfere with the operation of pedals, seats, compartments or safe driving abilities.
- Do not leave playing devices in your vehicle during extreme conditions as it could cause them damage. See your device's manual for further information.
- Do not attempt to service or repair the system. See an authorized dealer.

## Privacy Information

When a cellular phone is connected to SYNC, the system creates a profile within your vehicle that is linked to that cellular phone. This profile is created in order to offer you more cellular features and to operate more efficiently. Among other things, this profile may contain data about your cellular phone book, text messages (read and unread), and call history, including history of calls when your cellular phone was not connected to the system. In addition, if you connect a media device, the system creates and retains an index of supported media content. The system also records a short development log of approximately 10 minutes of all recent system activity. The log profile and other system data may be used to improve the system and help diagnose any problems that may occur.

The cellular profile, media device index, and development log will remain in the vehicle unless you delete them and are generally accessible only in the vehicle when the cellular phone or media player is connected. If you no longer plan to use the system or the vehicle, we recommend you perform a Master Reset to erase all stored information.



System data cannot be accessed without special equipment and access to the vehicle's SYNC module. Ford Motor Company and Ford of Canada will not access the system data for any purpose other than as described absent consent, a court order, or where required by law enforcement, other government authorities, or other third parties acting with lawful authority. Other parties may seek to access the information independently of Ford Motor Company and Ford of Canada. For further privacy information, see the section on 911 Assist. See **SYNC™ Applications and Services** (page 476).

## USING VOICE RECOGNITION

This system helps you control many features using voice commands. This allows you to keep your hands on the wheel and focus on what is around you.

### Initiating a Voice Session



Press the voice button. A list of available voice commands appears in the display.

### Global Voice Commands

These voice commands are always available. You can say them at any time.

Global voice commands	
(cancel   exit)	This command ends the voice session. You can also cancel a session by holding the voice button for two or more seconds.
help	This command provides you with hints, examples and instructions.
(main menu   start again)	This command restarts the voice session from the initial starting point.

You can say any of the voice commands that appear within open and close brackets that are separated by |. For example, where; (cancel | exit) appears you say; cancel or exit.

### Helpful Hints

- Make sure the interior of your vehicle is as quiet as possible. Wind noise from open windows and road vibrations may prevent the system from correctly recognizing spoken commands.
- Before giving a voice command, wait for the system announcement to finish, followed by a single tone. Any command spoken before this does not register with the system.
- Speak naturally, without long pauses between words.
- You can interrupt the system at any time while it is speaking by pressing the voice button. You can cancel a voice session by pressing and holding the voice button.

## System Interaction and Feedback

The system provides feedback through audible tones, prompts, questions and spoken confirmations depending on the situation and the chosen level of interaction. You can customize the voice recognition system to provide more or less instruction and feedback.

The default setting is to a higher level of interaction in order to help you learn to use the system. You can change these settings at any time.

### Adjusting the Interaction Level



Press the voice button. When prompted, say:

Voice Command	Action and Description
voice settings	
<b>Then either of the following:</b>	
interaction mode novice	Provides more detailed interaction and guidance. (Recommended for first time users.)
interaction mode advanced	Provides less audible interaction and guidance.

## Confirmation Prompts

Confirmation prompts are short questions the system asks when it is not sure of your request or when there is more than one possible response to your request.

**To adjust this setting press the voice button, when prompted say:**

Voice Command	Action and Description
voice settings	
<b>Then either of the following:</b>	
confirmation prompts off	Make a best guess from the command; you may still occasionally be asked to confirm settings.
confirmation prompts on	Clarify your voice command with a short question.

## Phone Confirmation

Using phone confirmations the system asks you to verify before placing any calls.

## SYNC™ (If Equipped)

**To adjust this setting press the voice button, when prompted say:**

Voice Command	Action and Description
voice settings	
<b>Then any of the following:</b>	
phone confirmation on	When enabled, this feature will prompt you to confirm any voice initiated call command prior to the call being placed.
phone confirmation off	The system will make a best guess; you may still occasionally be asked to confirm settings.

### Changing the Voice Settings

In addition to using voice commands to change the voice settings, you can also use the menu in the audio display.

**To change the voice settings press the Menu button then select:**

Menu Item
SYNC-Settings
Voice settings

**Note:** Depending on the current climate control settings, the fan speed may automatically go down while issuing voice commands or while making and receiving phone calls via SYNC to reduce the amount of background noise in the vehicle. The fan speed will automatically return to normal operation once the voice session ends. Fan speed can also be adjusted normally during a voice session, simply press fan buttons (or turn fan knob) to increase or decrease fan speed to desired setting.

*To disable this automatic fan speed reduction feature during voice sessions, press and hold the climate control AC and Recirculated air buttons simultaneously, release and then increase fan speed within 2 seconds. To re-enable this feature, repeat the above sequence.*

### USING SYNC™ WITH YOUR PHONE

Hands-free calling is one of the main features of SYNC. While the system supports a variety of features, many are dependent on your cellular phone's functionality. At a minimum, most cellular phones with Bluetooth wireless technology support the following functions:

- Answering an incoming call.
- Ending a call.
- Using privacy mode.
- Dialing a number.
- Redialing.
- Call waiting notification.
- Caller ID.

Other features, such as text messaging using Bluetooth and automatic phonebook download, are phone-dependent features. To check your phone's compatibility, see your phone's manual and visit [www.SYNCMyRide.com](http://www.SYNCMyRide.com), [www.SYNCMyRide.ca](http://www.SYNCMyRide.ca) or [www.syncmaroute.ca](http://www.syncmaroute.ca).

## Pairing a Phone for the First Time

Wirelessly pairing your phone with SYNC allows you to make and receive hands-free calls.

**Note:** SYNC can support downloading up to approximately 4000 entries per Bluetooth-enabled cellular phone.

**Note:** Make sure to switch on the ignition and the radio. Shift the transmission into park (P) for automatic transmission or first gear for manual transmission.

## Using the Audio System

**Note:** To scroll through the menus, press the up and down arrows on your audio system.

1. Make sure to switch on your phone's Bluetooth feature before starting the search. See your device's manual if necessary.
2. Press the **PHONE** button. When the audio display indicates there is no paired phone, select the option to add.
3. When a message to begin pairing appears in the audio display, search for SYNC on your phone to start the pairing process.

4. When prompted on your cell phone's display, confirm that the PIN provided by SYNC matches the PIN displayed on your cell phone. Your phone is now paired and the display indicates that the pairing was successful. If you are prompted to enter a PIN on your device, enter the PIN displayed on the screen. The display indicates when the pairing is successful.

Depending on your phone's capability and your market, the system may prompt you with questions, such as setting the current phone as the primary phone (the phone SYNC automatically tries to connect with first upon vehicle start-up) and downloading your phonebook.

## Using Voice Commands



Make sure to switch on your phone's Bluetooth feature before starting the search. See your device's manual if necessary.

## Press the voice and when prompted say:

Voice Command	Action and Description
(pair ([Bluetooth] device   phone   Bluetooth audio)   add phone)	Follow the instructions on the audio display.

You can say any of the voice commands that appear within open and close brackets that are separated by |. For example, where; (what's | what is) appears you say; what's or what is.

The commands that have [ ] around the word means that the word is optional.

Depending on your phone's capability and your market, the system may prompt you with questions, such as setting the current phone as the primary phone (the phone SYNC automatically tries to connect with first upon vehicle start-up) and downloading your phonebook.

## Pairing Subsequent Phones

**Note:** Make sure to switch on the ignition and the radio. Shift the transmission into park (P) for automatic transmission or first gear for manual transmission.

**Note:** To scroll through the menus, press the up and down arrows on your audio system.

1. Make sure to switch on your phone's Bluetooth feature before starting the search. See your device's manual if necessary.
2. Press the **PHONE** button.
3. Select the option for Bluetooth Devices.
4. Press the **OK** button.
5. Select the option to add. This starts the pairing process.
6. When a message to begin pairing appears in the audio display, search for SYNC on your device.
7. When prompted on your cell phone's display, confirm that the PIN provided by SYNC matches the PIN displayed on your cell phone. Your phone is now paired and the display indicates that the pairing was successful. If you are prompted to enter a PIN on your device, enter the PIN displayed on the screen. The display indicates when the pairing is successful.

SYNC may prompt you with more cell phone options. Your cell phone may also prompt you to give SYNC permission to access information. For more information on your cell phone's capability, see your cell phone's manual and visit the website.

## Phone Voice Commands



Press the voice button. When prompted, say any of the following:

Voice Command	
(phone   Blackberry   iPhone)	
<b>Then say any of the following:</b>	
call (___)	
call ___ at home	
call ___ ((in at) [the] office   at work)	
call ___ on (cell   mobile)	
call ___ on other	
dial [[a] number]	1
([go to] privacy   transfer to phone   privacy on)	2
(hold call [on]   place call on hold)	2
join (calls   call)	2
mute call [on]	2
(mute call off   un-mute call)	2
(turn ringer on   silent mode off)	
(turn ringer off   silent mode [on])	

Voice Command
[text] (messages   message) <sup>3</sup>
help

\_\_\_ is a dynamic listing that should be the name of a contact in your phonebook. For example you could say "Call Home".

<sup>1</sup> See **Dial** table below.

<sup>2</sup> These commands are only valid while in a phone call.

<sup>3</sup> See the text message table below.

## Dial Commands

Press the voice button and when prompted say any of the following commands:

Voice Commands
411 (four-one-one), 911 (nine-one-one)
700 (seven hundred)
800 (eight hundred)
900 (nine hundred)
Clear (deletes all entered digits)
Delete (deletes last set of digits entered)
Number <0-9>
Plus
Pound (#)
Star (*)

**Note:** To exit dial mode, press and hold the phone button or press any button on the audio system.

## To access text messages say:

Voice Command
[text] (messages   message)
<b>Then say any of the following:</b>
(listen to   read) ([text] message)
forward (text   [text] message)
reply to (text   [text] message)
call [sender]

## Phonebook Hints

To hear how the SYNC system speaks a name browse phonebook, select a contact and press:

Menu Item
Hear it

## Changing Devices Using Voice Commands

Using SYNC, you can easily access multiple phones, ipods, or USB devices. to switch devices say:

Voice Command	
(connect   device) ____	You can state the name of the desired device, such as “My iPhone”; “My Galaxy” or “My iPod”. SYNC may ask you to confirm the type of device (Phone, USB, or Bluetooth Audio).

## Making Calls



**Press the voice button. When prompted, say:**

Voice Command	
call [[a] name]	
dial [[a] number]	SYNC prompts you to say the numbers that you wish to dial. After you say the numbers, the system confirms it. You can then say:

**When the system has stated the number, you say any of the following:**

Voice Command	
(dial   send)	This initiates the call.
(delete   correct)	This erases the spoken digits.

To end the call, press the end call button

on the steering wheel or select the end call option in the audio display.

## Receiving Calls

### Accepting calls

When receiving a call, you can answer the call by pressing the accept call button on the steering wheel or use the screen.

**To use the screen to accept a call select:**

Menu Item
Accept

### Rejecting Calls

When receiving a call, you can reject the call by pressing the reject call button on the steering wheel or use the screen.

**To use the screen to reject a call select:**

Menu Item
Reject

Ignore the call by doing nothing.

## Phone Options during an Active Call

During an active call, you have more menu features that become available, such as putting a call on hold or joining calls.

To access this menu, choose one of the options available at the bottom of the audio display or select **More** to choose from the following options:

Menu Item	Description and action
Mic. off	Switch your vehicle's microphone off. To switch the microphone on, select the option again.
Privacy	Switch a call from an active hands-free environment to your cellular phone for a more private conversation. When selected, the audio display indicates the call is private.
Hold	Put an active call on hold. When selected, the audio display indicates the call is on hold.
Dial a number	Enter numbers using the audio system's numeric keypad (for example, numbers for passwords).
Join calls	Join two separate calls. The system supports a maximum of three callers on a multiparty or conference call. 1. Select the <b>More</b> option. 2. Access the desired contact through the system or use voice commands to place the second call. Once actively in the second call, select the <b>More</b> option. 3. Scroll to the option to join calls and press the <b>OK</b> button.
Phonebook	Access your phonebook contacts. 1. Select the <b>More</b> option. 2. Scroll to the option for phonebook and press the <b>OK</b> button. 3. Scroll through your phonebook contacts. 4. Press the <b>OK</b> button again when the desired contact appears in the audio display. 5. Press the <b>OK</b> button or dial button to call the selection.
Call History	Access your call history log. 1. Select the <b>More</b> option. 2. Scroll to the option for call history and press the <b>OK</b> button. 3. Scroll through your call history options (incoming, outgoing or missed). 4. Press the <b>OK</b> button again when the desired selection appears in the audio display. 5. Press the <b>OK</b> button or dial button to call the selection.

## Accessing Features through the Phone Menu

You can access your call history, phonebook, sent text messages, as well as access phone and system settings.

1. Press the **PHONE** button to enter the phone menu.
2. Select one of the options available.



# SYNC™ (If Equipped)

Display	Description and action
Dial a number	Enter numbers using the audio system's numeric keypad.
Phonebook	Access your downloaded phonebook. 1. Press the <b>OK</b> button to confirm and enter. You can use the options at the bottom of the screen to access an alphabetical category quickly. You can also use the letters on the audio system's numeric keypad to jump in the list. 2. Scroll through your phonebook contacts. 3. Press the <b>OK</b> button again when the desired selection appears in the audio display. 4. Press the <b>OK</b> button or dial button to call the selection.
Call History	Access any previously dialed, received or missed calls. 1. Press the <b>OK</b> button to select. 2. Scroll to select incoming, outgoing or missed calls. Press the <b>OK</b> button to make your selection. 3. Press the <b>OK</b> button or dial button to call the selection.
Speed Dial	Select 1 of 10 speed dial entries. To set a speed dial entry, go to the phonebook and then press and hold one of the numbers on the audio system's numeric keypad.
Text messaging	Send, download and delete text messages.
BT Devices	Access the option for Bluetooth Device menu listings (add, connect, set as primary, on or off, delete).
Phone settings	View various settings and features on your phone.

## Text Messaging

**Note:** This is a phone-dependent feature.

SYNC allows you to receive, send, download and delete text messages. The system can also read incoming text messages to you so that you do not have to take your eyes off the road.

### Receiving a Text Message

**Note:** This is a phone-dependent feature. Your phone must support downloading text messages using Bluetooth to receive incoming text messages.

**Note:** This is a speed-dependent feature and is only available when your vehicle is traveling at 3 mph (5 km/h) or less.

When a new message arrives, an audible tone sounds and the audio display indicates you have a new message.

### To hear the message you can say:

Voice command	Description and action
(listen to   read) ([text] message)	Select this option to have the system read the message to you.

**Using the screen you also have the following options:**

Menu Item	Description and action	
Ignore	Select this option, or do nothing, and the message goes into your text message inbox.	
View	Select the view option to open the text message. Once selected, you have the ability to have the message read to you, to view other messages. For additional options select:	
	More...	If you select this option, use the arrow button to scroll through the following options:
	Reply to sender	Press the <b>OK</b> button to access, and then scroll through a list of pre-defined messages to send.
	Call sender	Press the <b>OK</b> button to call the sender of the message.
	Forward msg.	Press the <b>OK</b> button to forward the message to anyone in your phonebook or call history. You can also choose to enter a number.

**Sending, Downloading and Deleting Your Text Messages**

1. Press the **PHONE** button.

2. Select the text messaging option, and then press the **OK** button.

**Choose from the following options:**

Menu Item	Description and action
New	Allows you to send a new text message based on a pre-defined set of 15 messages.
View	Allows you to read the full message and, in addition, provides the option to have the system read the message to you. To go to the next message, select the <b>More</b> option. This allows you to reply to the sender, call the sender or forward the message.
Delete	Allows you to delete current text messages from the system (not your cellular phone). The audio display indicates when the system has deleted all your text messages.
More...	Allows you to delete all messages or manually trigger a download of all unread messages from your cellular phone.

## Sending a Text Message

**Note:** You can only send a text message to one recipient at a time.

1. Select the send option when the desired selection highlights in the audio display.
2. Select the confirmation option when the contact appears.
3. Press the OK button again to confirm when the system asks if you want to send the message. A pre-defined signature appears on each text message.

**Note:** You can send text messages either by choosing a contact from the phonebook and selecting the text option from the audio display or by replying to a received message in the inbox.

## Accessing Your Phone Settings

These are phone-dependent features. Your phone settings allow you to access and adjust features such as your ring tone and text message notification, modify your phonebook, and set up automatic download.

1. Press the **PHONE** button.
2. Scroll until the phone settings option appears, and then press the **OK** button.

## Scroll to select from the following options:

Menu Item	Description and action
Set as master	If this option is checked, the system uses the cellular phone as the master when there is more than one cellular phone paired to the system. This option can be changed for all cellular phones (not only the active phone) using the Bluetooth Devices menu.
Phone status	See the cellular phone name, provider name, cellular phone number, and signal level. When done, press the left arrow buttons to return to the phone status menu.
Set ringtone	Select which ringtone sounds during an incoming call (one of the system's tones or your cellular phone's). If your phone supports in-band ringing, your phone's ringtone sounds when you choose the cellular phone ringtone option. 1. Press the <b>OK</b> button to select and scroll to hear each ringtone. 2. Press the <b>OK</b> button to select a ringtone.
Text msg notify	Have the option of hearing an audible tone to notify you when a text message arrives. Press the <b>OK</b> button to switch the audible tone off or on.
Phonebook pref.	Modify the contents of your phonebook (such as add, delete or download). Press the <b>OK</b> button to select and scroll between the choices in the phonebook preferences table below.

## SYNC™ (If Equipped)

Menu Item	Phonebook preferences	
Add contacts	Push the desired contacts on your cellular phone. See your device's manual on how to push contacts. Press the <b>OK</b> button to add more contacts from your phonebook.	
Delete	When a message asking you to delete appears, select the option to confirm. Press the <b>OK</b> button to delete the current phonebook and call history. The system takes you back to the menu for phone settings.	
Download now	Press the OK button to select and download your phonebook to the system.	
Auto-download	When automatic download is on, the system deletes any changes (additions or deletions) saved in the system since your last download.	
	When automatic download is off, the system does not download your phonebook when your cellular phone connects to SYNC.	
	You can only access your phonebook, call history and text messages when your paired cellular phone connects to the system. Check or uncheck this option to download your phonebook automatically each time your phone connects to the system. Download times are phone-dependent and quantity-dependent.	
Sorting Pref.	Enabling this feature allows you to select how your contacts are displayed. You can select:	
	<table border="1"> <tr> <td>First/Last name</td> <td>Last/First name</td> </tr> </table>	First/Last name
First/Last name	Last/First name	

### Bluetooth Devices

The Bluetooth Devices menu allows you to add, connect and delete devices as well as set a phone as primary.

1. Press the **PHONE** button.
2. Scroll until Bluetooth Devices appears, and then press the **OK** button.

### Select from the following options:

Menu Item	Description and action
Add	Pair additional phones to the system. 1. Select the option to add to start the pairing process.

## SYNC™ (If Equipped)

Menu Item	Description and action
	<p>2. When a message to begin pairing appears in the audio display, search for SYNC on your phone. See your phone's manual if necessary.</p> <p>3. When prompted on your cell phone's display, confirm that the PIN provided by SYNC matches the PIN displayed on your cell phone. Skip the next step. If you are prompted to enter a PIN on your device, it does not support Secure Simple Pairing. To pair, enter the PIN displayed on the screen. The display indicates when the pairing is successful.</p> <p>4. When the option to set the phone as primary appears, select either yes or no.</p> <p>5. SYNC may prompt you with more cell phone options. Your cell phone may also prompt you to give SYNC permission to access information. For more information on your cell phone's capability, see your cell phone's manual and visit the website.</p>
Delete	Select the delete option and confirm when the system asks to delete the selected device. After deleting a phone from the list, you have to repeat the pairing process to pair it again.
Master	The system attempts to connect with the primary cellular phone each time you switch on the ignition. When you select a cellular phone as primary, it appears first in the list, marked with an asterisk. Set a previously paired phone as master by selecting the master option and confirming it as the primary.
Conn.	Connect a previously connected phone. You can only have one phone connected at a time to use the phone's functionality. When you connect another phone, the previous phone disconnects from the telephone services. The system allows you to use different Bluetooth devices for the cellular phone functionality and the Bluetooth audio music playback feature at the same time.
Discon.	Disconnects the selected cellular phone. Select this option and confirm when asked. After disconnecting a phone, you can reconnect it again without repeating the full pairing process.

### System Settings

1. Press the **MENU** button.

2. Select the SYNC settings option, and then press the **OK** button.

**Scroll to select from the following options:**

<b>Display</b>	<b>Description and action</b>
Bluetooth on	Check or uncheck this option to switch the system's Bluetooth interface off or on. Select this option, and then press the <b>OK</b> button to change the option's status.
Set defaults	Return to the factory default settings without erasing your indexed information (such as phonebook, call history, text messages and paired devices). Select this option and confirm when prompted in the audio display.
Master reset	Completely erase all information stored in the system (such as phonebook, call history, text messages and paired devices) and return to factory default settings.
Install on SYNC	Install downloaded applications or software updates. Select this option and confirm when prompted in the audio display. There must be a valid SYNC application or update available on the USB drive in order to finish an installation successfully.
System info	Display the system's version numbers as well as its serial number. Press the <b>OK</b> button to select.
Voice settings	The voice settings submenu contains various options. See <b>Using Voice Recognition</b> (page 462).
Browse USB	Browse the actual menu structure of the connected USB device. Press the <b>OK</b> button and use the up and down arrow buttons to scroll through the folders and files. Use the left or right arrow buttons to enter or leave a folder. You can select media content for playback from this menu.

## SYNC™ APPLICATIONS AND SERVICES (If Equipped)

In order for the following features to work, your cellular phone must be compatible with SYNC. To check your phone's compatibility, visit [www.SYNCMYRide.com](http://www.SYNCMYRide.com), [www.SYNCMYRide.ca](http://www.SYNCMYRide.ca) or [www.syncmaroute.ca](http://www.syncmaroute.ca).

- 911 Assist: Can alert 911 in the event of an emergency.
- SYNC AppLink: Allows you to connect to and use certain applications such as Spotify and Glmpse (if your phone is compatible).

These features may require activation. Available AppLink enabled apps vary by market.

### 911 Assist

#### WARNINGS



Unless the 911 Assist setting is set on before a crash, the system will not dial for help which could delay response time, potentially increasing the risk of serious injury or death after a crash.



Do not wait for 911 Assist to make an emergency call if you can do it yourself. Dial emergency services immediately to avoid delayed response time which could increase the risk of serious injury or death after a crash. If you do not hear 911 Assist within five seconds of the crash, the system or phone may be damaged or non-functional.



Always place your phone in a secure location in your vehicle so it does not become a projectile or get damaged in a crash. Failure to do so may cause serious injury to someone or damage the phone which could prevent 911 Assist from working properly.

**Note:** The SYNC 911 Assist feature must be set on before the incident.

**Note:** The SYNC 911 Assist feature only operates in the U.S., Canada or in a territory in which 911 is the emergency number.

**Note:** Before setting this feature on, make sure that you read the 911 Assist Privacy Notice later in this section for important information.

**Note:** If any user switches 911 Assist to on or off, that setting applies for all paired phones. If 911 Assist is switched off, either a voice message plays or a display message or an icon comes on when your vehicle is started and after a previously paired phone connects.

**Note:** Every phone operates differently. While SYNC 911 Assist works with most cellular phones, some may have trouble using this feature.

If a crash deploys an airbag (excluding knee airbags and rear inflatable safety belts [if equipped]) or activates the fuel pump shut-off, your SYNC-equipped vehicle may be able to contact emergency services by dialing 911 through a paired and connected Bluetooth-enabled phone. You can learn more about the 911 Assist feature, visit [www.SYNCMYRide.com](http://www.SYNCMYRide.com), [www.SYNCMYRide.ca](http://www.SYNCMYRide.ca) or [www.syncmaroute.ca](http://www.syncmaroute.ca).

See **Supplementary Restraints System** (page 46). Important information about airbag deployment is in this chapter.

See **Roadside Emergencies** (page 303). Important information about the fuel pump shut-off is in this chapter.

## Setting 911 Assist On or Off

### Press Menu then select

Menu Item	Action and Description
SYNC-Applications	
911 Assist	Select the desired option, on or off.

### If you choose not to activate this feature you will have the following options:

Menu Item	Action and Description
Voice Reminder ON	Provides a display and voice reminder at phone connection at vehicle start.
Voice Reminder OFF	Provides a display reminder only without a voice reminder at phone connection.

To make sure that 911 Assist works properly:

- SYNC must be powered and working properly at the time of the incident and throughout feature activation and use.
- The 911 Assist feature must be set on before the incident.
- You must pair and connect a Bluetooth-enabled and compatible cell phone to SYNC.
- A connected Bluetooth-enabled phone must have the ability to make and maintain an outgoing call at the time of the incident.

- A connected Bluetooth-enabled phone must have adequate network coverage, battery power and signal strength.
- The vehicle must have battery power and be located in the U.S., Canada or in a territory in which 911 is the emergency number.

### In the Event of a Crash

Not all crashes deploy an airbag or activate the fuel pump shut-off (the triggers for 911 Assist). If a connected cell phone sustains damage or loses its connection to SYNC during a crash, SYNC searches for and tries to connect to a previously paired cell phone; SYNC then attempts to call the emergency services.

Before making the call:

- SYNC provides a short window of time (about 10 seconds) to cancel the call. If you fail to cancel the call, SYNC attempts to dial 911.
- SYNC says the following, or a similar message: "SYNC will attempt to call 911, to cancel the call, press Cancel on your screen or press and hold the phone button on your steering wheel".

If you do not cancel the call, and SYNC makes a successful call, a pre-recorded message plays for the 911 operator, and then the occupant(s) in your vehicle is able to talk with the operator. Be prepared to provide your name, phone number and location immediately, because not all 911 systems are capable of receiving this information electronically.

### 911 Assist May Not Work If

- Your cellular phone or 911 Assist hardware sustains damage in a crash.
- The vehicle's battery or the SYNC system has no power.
- The phone(s) thrown from your vehicle are the ones paired and connected to the system.



## 911 Assist Privacy Notice

When you switch on 911 Assist, it may disclose to emergency services that your vehicle has been in a crash involving the deployment of an airbag or activation of the fuel pump shut-off. Certain versions or updates to 911 Assist may also be capable of electronically or verbally disclosing to 911 operators your vehicle location or other details about your vehicle or crash to assist 911 operators to provide the most appropriate emergency services. If you do not want to disclose this information, do not switch the feature on.

## SYNC Mobile Apps

The system enables voice and steering wheel control of SYNC AppLink enabled smartphone apps. When an app is running through AppLink, you can control main features of the app through voice commands and steering wheel controls.

**Note:** You must pair and connect your smartphone to SYNC to access AppLink.

**Note:** iPhone users need to connect the phone to the USB port.

**Note:** Android users need to connect the phone to SYNC using Bluetooth.

**Note:** For information on available apps, supported smartphone devices and troubleshooting tips please visit the Ford website.

Availability of SYNC AppLink enabled Apps will vary by region.

**Note:** Make sure you have an active account for the app that you have downloaded. Some apps work automatically with no setup. Other apps want you to configure your personal settings and personalize your experience by creating stations or favorites. We recommend you do this at home or outside of your vehicle.

**Note:** AppLink is not available if your vehicle is equipped with the MyFordTouch system.

## To Access Using the SYNC Menu

**Press the MENU button to access the menu on-screen. Then select:**

Menu Item	Action and Description
SYNC-Apps	
Mobile Apps	Scroll through the list of available applications and select a particular app or select:
	Find New Apps

**Note:** If you cannot find a compatible SYNC AppLink app, make sure the required app is running on the mobile device.

## Accessing an App's Menu

When an app is running through SYNC, press the right arrow button on the steering wheel control to access the app menu.

You can access various app features from here, for example thumbs up and thumbs down.

Press the left arrow button on the steering wheel control to exit the app menu.

## To Access Using Voice Commands

**Press the voice button then when prompted say:**

Menu Item	Action and Description
mobile (apps   applications)	Say the name of the application after the tone. The app should start. When an app is running through SYNC, you can press the voice button and speak commands specific to the app, for example "Play Playlist Road Trip".
help	Use this command to discover the available voice commands.

## SYNC Mobile App Voice Commands

**The following voice commands are always available:**

Menu Item	Action and Description
mobile (apps   applications)	SYNC prompts you to say the name of an app to start it on SYNC.
list [mobile] (apps   applications)	SYNC lists all of the currently available mobile apps.
find [new] [mobile] (apps   applications)	Searches your connected mobile device for SYNC-compatible mobile apps.
help	
You can say the name of a mobile app at any time to start the mobile app on SYNC.	

## App Permissions

App permissions are organized by groups. You can grant these group permissions individually. You can change a permission group status any time when not driving, by using the settings menu.

When you launch an app using SYNC, the system may ask you to grant certain permissions, for example:

- To allow your vehicle to provide vehicle information to the app such as, but not limited to: Fuel level, fuel economy, fuel consumption, engine speed, rain sensor, odometer, VIN, external temperature, gear position, tire pressure, and head lamp status.
- To allow your vehicle to provide driving characteristic information such as, but not limited to: MyKey, seat belt status, engine revolutions per minute, gear position, braking events, steering wheel angle, and accelerator pedal position.

## SYNC™ (If Equipped)

- To allow your vehicle to provide location information, including: GPS and speed.
- To allow the app to send push notifications using the vehicle display and voice capabilities while running in a background state. Push notifications may be particularly useful for news or

location based apps.

**Note:** You only need to grant permissions the first time you use an app with SYNC.

**Note:** Ford is not responsible or liable for any damages or loss of privacy relating to usage of an app, or dissemination of any vehicle data that you approve Ford to provide to an app.

### Enabling and Disabling App Permissions Using the SYNC Menu

Press the MENU button to access the SYNC menu then select:

Menu Item	Action and Description
SYNC-Apps	
Mobile Apps	
All Apps	You can also select a specific app. If the app supports push notifications, this setting is listed. Select to enable or disable the feature as required.

### Enabling SYNC Mobile Apps

In order to enable mobile apps, SYNC requires user consent to send and receive app authorization information and updates using the data plan associated with the connected device.

Data is sent to Ford in the United States through the connected device. The information is encrypted and includes your VIN, SYNC module number, anonymous usage statistics and debugging information. Updates may take place automatically.

**Note:** You must enable mobile apps for each connected device the first time you select a mobile app using the system.

**Note:** Standard data rates apply. Ford is not responsible for any additional charges you may receive from your service provider, when your vehicle sends or receives data through the connected device. This includes any additional charges incurred due to driving in areas when roaming out of a home network.

### App Status

You can view the current status of an app in the settings menu.

## There are three possible statuses:

Menu Item	Action and Description
Update Needed	The system has detected a new app requiring authorization or a general permissions update is required.
Up-To-Date	No update is required.
Updating...	The system is trying to receive an update.

## Update settings

Menu Item	Action and Description
Request Update	Select this option from the settings menu to manually preform a needed update.
Disable Updates	Select this option from the settings menu to disable automatic updates. Doing so also disables the use of Mobile Apps on SYNC.

## USING SYNC™ WITH YOUR MEDIA PLAYER

You can access and play music from your digital music player over your vehicle's speaker system using the system's media menu or voice commands. You can also sort and play your music by specific categories, such as artist and album.

**Note:** *The system is capable of indexing up to 15,000 songs.*

SYNC is capable of hosting nearly any digital media player including: iPod, Zune, plays from device players, and most USB drives. SYNC also supports audio formats, such as MP3, WMA, WAV and ACC.

Confirm that the USB device has been formatted correctly and has the following specifications:

- USB 2.0.
- File format must be FAT16/32.

The format of the audio files on the USB device must be:

- MP3.
- Non DRM protected WMA.
- WAV.
- AAC.

## Connecting Your Digital Media Player to the USB Port

**Note:** *If your digital media player has a power switch, make sure you switch it on before plugging it in.*

## To Connect Using Voice Commands

Plug the device into one of the vehicle's USB ports.

**Press the voice button and when prompted, say:**

Voice Command	Action and Description
(USB [stick]   iPod   MP3 [player])	You can now play music by saying any of the appropriate voice commands. See the media voice commands.

Words in brackets [ ] are optional and do not have to be spoken for the system to understand the command. For example, for where (USB [stick] | IPOD | MP3 [player]) appears, you can say USB or USB stick.

## To view USB content select:

Message	Description and Action
Browse USB	Depending on how many media files are on your connected device, an indexing message may appear in the display. When indexing is complete, the selected source starts to playback audio automatically.

**You can browse the files on the USB device in categories. Select BROWSE from the buttons at the bottom of the audio display and choose from the following:**

Message
Play all
Playlists
Songs
Artists

## To Connect Using the System Menu

1. Plug the device into one of the vehicle's USB ports.
2. Press the **MEDIA** button and select either USB 1 or USB 2 from the media source list in the audio display.

Message
Albums
Genres
Browse USB
Reset USB

## Media Voice Commands



Press the voice button and when prompted say:

## SYNC™ (If Equipped)

Voice Command	Description and Action
(USB [stick]   iPod   MP3 [player])	You can now play music by saying any of the appropriate voice commands.

You can say any of the voice commands that appear within open and close brackets that are separated by |. For example, where; (what's | what is) appears you say; what's or what is.

You must say any of the voice commands that appear outside of open and close brackets. For example, where; (what's | what is) playing, you must say either "what's playing" or "what is playing".

Command	Description and Action
pause	Pauses device playback.
play	Resumes device playback.
play [album] ___	
play all	Play all media on the device from the first track to the last.
play [artist] ___	
play [genre] ___	
play [playlist] ___	
next [track   title   song   file   podcast   chapter   episode]	Plays the next track   on the current media.
previous [track   title   song   file   podcast   chapter   episode]	Plays the previous track on current media.
[play] (similar music   more like this)	Creates a playlist with a similar genre to the one currently playing.
play [song   track   title   file] ___	
repeat off	
repeat (one   track) [on]	Repeats the current track.

## SYNCTM (If Equipped)

Command	Description and Action
shuffle [all] [on]	Plays the current playlist in a random order. (Not all devices support this command.)
shuffle off	
((who's   who is) this   who plays this   (what's   what is) playing [now]   (what   which) (song   track   artist) is this   (who's   who is) playing   (what's   what is) this)	At any time during playback, you can press the voice button and ask the system what is playing. The system reads the metadata tags (if populated) of the current track.

\_\_\_ is a dynamic listing, meaning that it could be the name of anything, such as a group, artist or song. For example you could say "Play artist The Beatles".

### Examples of USB Commands

SYNCTM provides the user with many intuitive ways to find and play a song using voice. For example, if we have a song called "Penny Lane" from the album "Magical Mystery Tour" we can say the following to play this song:

- Play song "Penny Lane".
- Play "Penny Lane".

If we wanted to play the entire album, we can say:

Voice Command
pause
play
next [track   title   song   file   podcast   chapter   episode]
previous [track   title   song   file   podcast   chapter   episode]

### Media Menu Features

The media menu allows you to select how to play your music (such as by artist, genre, shuffle or repeat), find similar music or reset the index of your USB devices.

- Play album "Magical Mystery Tour".
- Play "Magical Mystery Tour".

### Bluetooth Audio

The system is also capable of playing music from your cellular phone through Bluetooth.

To switch the Bluetooth Audio on, press the MEDIA button and select:

Menu Item
BT audio

Then any of the following:

Press the **MEDIA** button and select either USB 1 or USB 2 from the media source list in the audio display to start USB playback.

## SYNC™ (If Equipped)

Message	Description and Action
Options	This will enter the media menu.

Then any of the following:

Message	Description and Action
Shuffle	Choose to shuffle or repeat your music. Once you make your choice, it remains on until you switch it off.
Repeat track	Choose to shuffle or repeat your music. Once you make your choice, it remains on until you switch it off.
Similar music	You can play similar types of music to the current playlist from the USB port. The system uses the metadata information of each track to compile a playlist. The system then creates a new list of similar tracks and then begins playing. Each track must have the metadata tags populated for this feature. With certain playing devices, if your metadata tags are not populated, the tracks will not be available in voice recognition, the play menu or this option. However, if you place these tracks onto your playing device in mass storage device mode they are available in voice recognition, the play menu or this option. The system places unknowns into any unpopulated metadata tag.
Reset USB	Resets the USB index. After the new indexing is complete you can choose what to play from the USB song library.

### Accessing Your USB Song Library

1. Plug the device into your vehicle's USB port.
2. Press the **MEDIA** button (next to the audio display) to select USB playback.

Message	Description and Action
Browse USB	This menu allows you to select and play your media files by artist, album, genre, playlist or track.

If there are no media files to access, the display indicates there is no media.



## SYNC™ (If Equipped)

### If there are media files, you have the following options:

Display	Description and Action
Play all	Play all indexed media files from your device one at a time in numerical order.* Press the <b>OK</b> button to select. The first track title appears in the display.
Playlists	Access your playlists (from formats like ASX, M3U, WPL, or MTP).* 1. Press the <b>OK</b> button to select. 2. Scroll to select the desired playlist, and then press the <b>OK</b> button.
Songs	Search for and play a specific indexed track.* 1. Press the <b>OK</b> button to select. 2. Scroll to select the desired track, and then press the <b>OK</b> button.
Artists	Sort all indexed media files by artist. The system then lists and plays all artists and tracks alphabetically.* 1. Press the <b>OK</b> button to select. 2. Scroll to select the desired artist, and then press the <b>OK</b> button.
Albums	Sort all indexed media files by album.* 1. Press the <b>OK</b> button to select. 2. Scroll to select the desired album, and then press the <b>OK</b> button.
Genres	Sort all indexed media files by genre (category) type.* 1. Press the <b>OK</b> button to select. 2. Scroll to select the desired genre, and then press the <b>OK</b> button.
Browse USB	Browse all supported media files on your media player connected to the USB port. You can only view media files that are compatible with SYNC. (Other files are not visible.) 1. Press the <b>OK</b> button to select.

## SYNC™ (If Equipped)

Display	Description and Action
	2. Scroll to browse indexed media files on the device, and then press the <b>OK</b> button.
Reset USB	Resets the USB index. After the new indexing is complete, you can choose what to play from the USB song library.

\*You can use the buttons at the bottom of the audio display to jump to a certain alphabetical category quickly. You can also use the letters on the audio system's numeric keypad to jump in the list.

### Using Voice Commands

You can access and view your USB songs using voice commands.

Plug the device into your vehicle's USB port.

**Press the voice button and when prompted, say any of the following commands:**

Accessing and Viewing USB Media
(browse   search   show) all (album   albums)
(browse   search   show) all (artist   artists)
(browse   search   show) all (genre   genres)
(browse   search   show) all (playlist   playlists)
(browse   search   show) all (song   songs   title   titles   file   files   track   tracks)
(browse   search   show) album ____
(browse   search   show) artist ____
(browse   search   show) genre ____
(browse   search   show) playlist ____

### USB 2 (If Equipped)

Your vehicle may come equipped with an additional USB port. If so, USB 1 is located at the front of the vehicle at the bottom of the instrument panel. USB 2 is located inside the storage compartment of the vehicle's center console.

You can plug in an additional USB device into the second USB port.

You can access both USB devices by using voice commands.

**To access a USB device press the voice button and when prompted say:**

Voice command
USB 1
USB 2

**Note:** SYNC only supports one connected iOS (Apple) devices at a time (whichever one you plug in first). When you connect a second iOS device, the systems charges it, but does not support playback from it.

### Bluetooth Devices and System Settings

You can access these menus using the audio display. See **Using SYNC™ With Your Phone** (page 464).

## Voice Commands for Audio Sources

Your voice system allows you to change audio sources with a simple voice command.



**Press the voice button and when prompted say:**

Voice Command
(music   audio   entertainment) [system]
<b>Below are a few examples of voice commands you can use.</b>
[tune [to]] AM
[tune [to]] AM1
[tune [to]] AM (autostore   AST   autoset)
[tune [to]] AM 2
Bluetooth (audio   stereo)
(disc   CD [player]) play
[tune [to]] FM
[tune [to]] FM1
[tune [to]] FM (autostore   AST   autoset)
[tune [to]] FM 2
Radio
tune [to] SAT *
Sirius *
(USB [stick]   iPod   MP3 [player])

## Voice Command

((who's | who is) this | who plays this | (what's | what is) playing [now] | (what | which) (song | track | artist) is this | (who's | who is) playing | (what's | what is) this)

help

\* If equipped.

## Radio Voice Commands



If you are listening to the radio, press the voice button, and then say any of the commands in the following table.

**If you are not listening to the radio, press the voice button and, after the tone, say:**

Voice Command
Radio
<b>You can then say any of the following commands.</b>
[tune [to]] AM
[tune [to]] AM1
[tune [to]] AM (autostore   AST   autoset)
[tune [to]] AM 2
[tune [to]] (AM ___   ___ [AM])
[tune [to]] AM preset ___
[tune [to]] AM1 preset ___
[tune [to]] FM
[tune [to]] FM1
[tune [to]] FM (autostore   AST   autoset) preset ___

## SYNC™ (If Equipped)

Voice Command
[tune [to]] FM 2
[tune [to]] (FM ___   ___ [FM])
[tune [to]] FM preset ___
FM ___ HD ___ *
[tune [to]] FM 2 preset ___
HD ___ *
[tune [to]] preset ___
Tune
help

\* If equipped.

### Sirius Satellite Radio Voice Commands (If equipped)



To listen to Sirius satellite radio, press the voice button and, after the tone, say:

Voice Commands
Sirius

**When you are listening to Sirius satellite radio, you can press the voice button, and say any of the commands in the following table.**

Voice Commands
tune [to] SAT
[tune [to]] SAT 1
[tune [to]] SAT 2
[tune [to]] SAT 3
[tune [to]] preset ___
[tune [to]] SAT 1 preset ___

Voice Commands	
[tune [to]] SAT 2 preset ___	
[tune [to]] SAT 3 preset ___	
tune [to] [Sirius]	
Help	
[tune [to]] Sirius [channel] ___	You can say the channel number (0-233) to listen to that Sirius station.

### CD Voice Commands



If you are listening to a CD, press the voice button, and then say any of the commands in the following table.

**If you are not listening to a CD, press the voice button and, after the tone, say:**

Voice Command
(disc   CD [player]) play
<b>You can then say any of the following commands.</b>
pause
play
[play] next track
[play] previous track
[play   change to] track [number] ___
repeat (track   song) [on]
repeat folder [on]
repeat off
(shuffle   random   mix) [on   (tracks   songs) [on]]

## SYNC™ (If Equipped)

Voice Command
(shuffle   random   mix) (CD [player]   disc) [on]
(shuffle   random   mix) folder [on]
shuffle off

Use the website at any time to check your phone's compatibility, register your account and set preferences as well as access a customer representative via an online chat (during certain hours). Visit [www.SYNCMyRide.com](http://www.SYNCMyRide.com), [www.SYNCMyRide.ca](http://www.SYNCMyRide.ca) or [www.syncmaroute.ca](http://www.syncmaroute.ca) for more information.

## SYNC™ TROUBLESHOOTING

Your SYNC system is easy to use. However, should questions arise, see the tables below.

Phone issues		
Issue	Possible cause(s)	Possible solution(s)
There is excessive background noise during a phone call.	The audio control settings on your phone may be affecting SYNC performance.	Review your phone's manual about audio adjustments.
During a call, I can hear the other person but they cannot hear me.	This may be a possible phone malfunction.	Try turning off the device, resetting the device, removing the device's battery, then trying again.
SYNC is not able to download my phonebook.	This is a phone-dependent feature.  This may be a possible phone malfunction.	Go to the website to review your phone's compatibility.  Try turning off the device, resetting the device or removing the device's battery, then trying again.  Try pushing your phonebook contacts to SYNC by using the Add Contacts feature.  Use the SYNCmyphone feature available on the website.
The system says Phonebook Downloaded but the phonebook in SYNC is empty or missing contacts.	This may be a limitation on your phone's capability.	Try pushing your phonebook contacts to SYNC by using the Add Contacts feature.

## SYNC™ (If Equipped)

<b>Phone issues</b>		
<b>Issue</b>	<b>Possible cause(s)</b>	<b>Possible solution(s)</b>
		<p>If the missing contacts are stored on your SIM card, try moving them to the device memory.</p> <p>Remove any pictures or special ring tones associated with the missing contact.</p> <p>Depending upon your phone, you may have to grant SYNC permission to access your phonebook contacts. Make sure to confirm when prompted by your phone during the phonebook download.</p>
<p>I am having trouble connecting my phone to SYNC.</p>	<p>This is a phone-dependent feature.</p> <p>This may be a possible phone malfunction.</p>	<p>Go to the website to review your phone's compatibility.</p> <p>Try turning off the device, resetting the device or removing the device's battery, then trying again.</p> <p>Try deleting your device from SYNC, deleting SYNC from your device and trying again.</p> <p>Check the security and auto accept and prompt always settings relative to the SYNC Bluetooth connection on your phone.</p> <p>Update your device's firmware.</p>

## SYNC™ (If Equipped)

<b>Phone issues</b>		
<b>Issue</b>	<b>Possible cause(s)</b>	<b>Possible solution(s)</b>
		Turn off the Auto phone-book download setting.
Text messaging is not working on SYNC.	<p>This is a phone-dependent feature.</p> <p>This may be a possible phone malfunction.</p>	<p>Go to the website to review your phone's compatibility.</p> <p>Try turning off the device, resetting the device or removing the device's battery, then trying again.</p>

<b>USB and media issues</b>		
<b>Issue</b>	<b>Possible cause(s)</b>	<b>Possible solution(s)</b>
I am having trouble connecting my device.	This may be a possible device malfunction.	<p>Try turning off the device, resetting the device, removing the device's battery, then trying again.</p> <p>Make sure you are using the manufacturer's cable.</p> <p>Make sure you insert the USB cable correctly into the device and the USB port.</p> <p>Make sure that the device does not have an auto-install program or active security settings.</p>
SYNC does not recognize my device when I turn on the car.	This is a device limitation.	Make sure you are not leaving the device in your vehicle during very hot or cold temperatures.
Bluetooth audio does not stream.	This is a phone-dependent feature.	Review the device compatibility chart on the SYNC website to confirm your phone supports the Bluetooth audio streaming function.

## SYNC™ (If Equipped)

<b>USB and media issues</b>		
<b>Issue</b>	<b>Possible cause(s)</b>	<b>Possible solution(s)</b>
	The device is not connected.	Make sure you correctly connect the device to SYNC, and that you have pressed play on your device.
SYNC does not recognize music that is on my device.	<p>Your music files may not contain the correct artist, song title, album or genre information.</p> <p>The file may be corrupted.</p> <p>The song may have copyright protection, which does not allow it to play.</p>	<p>Make sure that all song details are populated.</p> <p>Some devices require you to change the USB settings from mass storage to MTP class.</p>

<b>Voice command issues</b>		
<b>Issue</b>	<b>Possible cause(s)</b>	<b>Possible solution(s)</b>
SYNC does not understand what I am saying.	<p>You may be using the wrong voice commands.</p> <p>You may be speaking too soon or at the wrong time.</p>	<p>Review the phone voice commands and the media voice commands at the beginning of their respective sections.</p> <p>After pressing the voice icon, wait until after the tone sounds and Listening appears before saying a command. Any command spoken before this does not register with the system.</p>
SYNC does not understand the name of a song or artist.	You may be using the wrong voice commands.	Review the media voice commands at the beginning of the media section.



## SYNCTM (If Equipped)

<b>Voice command issues</b>		
<b>Issue</b>	<b>Possible cause(s)</b>	<b>Possible solution(s)</b>
	<p>You may be saying the name differently than the way you saved it.</p> <p>The system may not be reading the name the same way you are saying it.</p>	<p>Say the song or artist exactly as listed. If you say "Play Artist Prince", the system does not play music by Prince and the Revolution or Prince and the New Power Generation.</p> <p>Make sure you are saying the complete title, such as "California remix featuring Jennifer Nettles".</p> <p>If the song titles are in all CAPS, you have to spell them. LOLA requires you to say "L-O-L-A".</p> <p>Do not use special characters in the title. The system does not recognize them.</p>
<p>SYNC does not understand or is calling the wrong contact when I want to make a call.</p>	<p>You may be using the wrong voice commands.</p> <p>You may be saying the name differently than the way you saved it.</p>	<p>Review the Phone voice commands at the beginning of the phone section.</p> <p>Make sure you are saying the contacts exactly as they are listed. For example, if you save a contact as Joe Wilson, say "Call Joe Wilson".</p> <p>Using the SYNC phone menu, open the phonebook and scroll to the name SYNC is having trouble understanding. SYNC will read the name to you, giving you some idea of the pronunciation SYNC is expecting.</p>

## SYNC™ (If Equipped)

<b>Voice command issues</b>		
<b>Issue</b>	<b>Possible cause(s)</b>	<b>Possible solution(s)</b>
	<p>The system may not be reading the name the same way you are saying it.</p> <p>Contacts in your phonebook may be very short and similar, or they may contain special characters.</p> <p>Your phonebook contacts may be in CAPS.</p>	<p>The system works better if you list full names, such as "Joe Wilson" rather than "Joe".</p> <p>Do not use special characters, such as 123 or ICE, as the system does not recognize them.</p> <p>If a contact is in CAPS, you have to spell it. JAKE requires you to say "Call J-A-K-E".</p>

<b>AppLink issues</b>		
<b>Issue</b>	<b>Possible cause(s)</b>	<b>Possible solution(s)</b>
<p>AppLink Mobile Applications: When I select "Find New Apps," SYNC does not find any applications.</p>	<p>An AppLink capable phone is not connected to SYNC.</p>	<p>Ensure you have a compatible smartphone; an Android with OS 2.3 or higher or an iPhone 3GS or newer with iOS 5.0 or higher. Additionally, ensure your phone is paired and connected to SYNC in order to find AppLink-capable apps on your device. iPhone users must also connect to SYNC's USB port with an Apple USB cable.</p>
<p>My phone is connected, but I still cannot find any apps.</p>	<p>AppLink-enabled apps are not installed and running on your mobile device.</p>	<p>Ensure you have downloaded and installed the latest version of the app from your phone's app store. Ensure the app is running on your phone. Some apps require you to register or</p>

## SYNC™ (If Equipped)

<b>AppLink issues</b>		
<b>Issue</b>	<b>Possible cause(s)</b>	<b>Possible solution(s)</b>
		login on the app on the phone before using them with AppLink. Also, some may have a "Ford SYNC" setting, so check the app's settings menu on the phone.
My phone is connected, my app(s) are running, but I still cannot find any apps.	Sometime apps do not properly close and re-open their connection to SYNC, over ignition cycles, for example.	<p>Closing and restarting apps may help SYNC find the application if you cannot discover it inside the vehicle.</p> <p>On an Android device, if apps have an "Exit" or 'Quit' option, select that then restart the app. If the app does not have that option, you can also manually "Force Close" the app by going to the phone's settings menu, selecting 'Apps.' then finding the particular app and choosing 'Force stop.' Don't forget to restart the app afterwards, then select "Find New Apps" on SYNC.</p> <p>On an iPhone with iOS7+, to force close an app, double tap the home button then swipe up on the app to close it. Tab the home button again, then select the app again to restart it. After a few seconds, the app should then appear in SYNC's Mobile App's Menu.</p>
My Android phone is connected, my app(s) are running, I restarted them, but I still cannot find any apps.	There is a Bluetooth bug on some older versions of the Android operating system that may cause apps that were found on your previous vehicle drive to not be found again if you have not turned off Bluetooth.	Reset the Bluetooth on your phone by turning it off and then turning Bluetooth back on. If you are in your vehicle, SYNC should be able to automatically re-connect to your phone if you press the "Phone" button.

## SYNC™ (If Equipped)

<b>AppLink issues</b>		
<b>Issue</b>	<b>Possible cause(s)</b>	<b>Possible solution(s)</b>
My iPhone phone is connected, my app is running, I restarted the app but I still cannot find it on SYNC.	The USB connection to SYNC may need to be reset.	Unplug the USB cable from the phone, wait a moment, and plug the USB cable back in to the phone. After a few seconds, the app should appear in SYNC's Mobile Apps Menu. If not, "Force Close" the application and restart it.
I have an Android phone. I found and started my media app on SYNC, but there is no sound or the sound is very low.	The bluetooth volume on the phone may be low.	Try increasing the Bluetooth volume of the device by using the device's volume control buttons which are most often found on the side of the device.
I can only see some of the AppLink apps running on my phone listed in SYNC's Mobile Apps Menu.	Some Android devices have a limited number of bluetooth ports apps can use to connect. If you have more AppLink apps on your phone than the number of available Bluetooth ports, you will not see all of your apps listed in SYNC's mobile apps menu.	Force close or uninstall the apps you do not want SYNC to find. If the app has a "Ford SYNC" setting, disable that setting in the app's settings menu on the phone.

### **SYNC System Reset**

The SYNC system in your vehicle has System Reset feature that can be performed if the function of a SYNC feature is lost. This reset is intended to restore functionality and will not erase any information previously stored in the system (Such as paired devices, phonebook, call history, text messages, or user settings). To perform a System Reset, press and hold the Seek Up (>>) button while pressing and holding the Radio Power button. Release both buttons after 2-3 seconds. Please allow a few minutes for the reset to complete. After a few minutes has passed you can resume using the SYNC system.

# SYNC™ 3 (If Equipped)

## GENERAL INFORMATION

### WARNING



Driving while distracted can result in loss of vehicle control, crash and injury. We strongly recommend that you use extreme caution when using any device that may take your focus off the road. Your primary responsibility is the safe operation of your vehicle. We recommend against the use of any hand-held device while driving and encourage the use of voice-operated systems when possible. Make sure you are aware of all applicable local laws that may affect the use of electronic devices while driving.

## Getting to Know Your System

The SYNC 3 system allows you to interact with a variety of features using the touchscreen and voice commands. By integrating with your Bluetooth-enabled phone, the touchscreen provides easy interaction with audio, multimedia, climate control, navigation, and your phone's SYNC 3 compatible apps.

### Using the Touchscreen

To operate the touchscreen, you can simply touch the item or option that you want to select. The button changes color when you select it.

The SYNC 3 layout allows you to quickly select the feature you wish to use.



E205444

## SYNCTM 3 (If Equipped)

Item	Menu Item	Action and Description
A	Status Bar	This bar displays icons and messages pertaining to current system activities including climate settings, voice commands and phone functions such as text messages.
B	Home	This button is available on the main screens. Pressing it takes you to the home screen view.
C	Clock	This shows the current time. You can set the clock manually or have it controlled by the vehicle's GPS location. See <b>Settings</b> (page 546).
D	Outside Temperature	This displays the current outside temperature.
E	Feature Bar	You can touch any of the buttons on this bar to select a feature.

The touchscreen allows you quick access to all of your comfort, navigation, communication and entertainment options. Using the status and feature bar you can quickly select the feature you want to use.

**Note:** *Your system is equipped with a feature that allows you to access and control audio features for 10 minutes after you switch the ignition off (and no doors open).*

### The Status Bar

Additional icons also display in the status bar depending on market, vehicle options and current operation. If a feature is not active, the icon does not display. Certain icons may move to the left or right depending on what options are active.

# SYNC™ 3 (If Equipped)

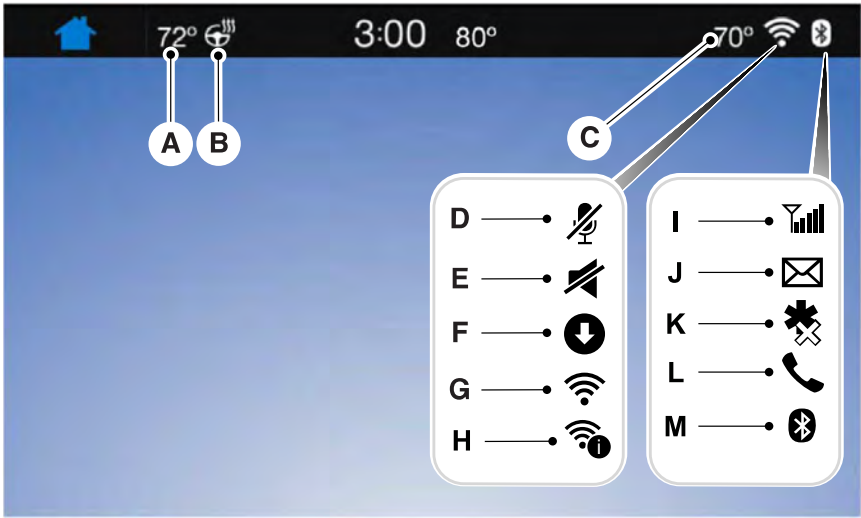

E249671

Callout	Item	Description
A	Driver Temperature	This shows the temperature the driver selects through the climate control system.
B	Heated steering wheel (If equipped)	When you activate the heated steering wheel option on the touch screen, this icon displays. It only displays when there is not a physical button for the heated steering wheel.
C	Passenger Temperature	When the passenger's temperature has been adjusted and is no longer linked to the driver's temperature, it displays here. If Dual is turned off and the temperatures are linked, the passenger's temperature does not display.
D	Microphone Mute	This icon displays when your phone's microphone is muted. A caller cannot hear you.
E	Mute	This icon displays when the audio system is muted.

## SYNC™ 3 (If Equipped)

Callout	Item	Description
F	Download	This icon appears when SYNC 3 receives a software update. Pressing the icon shows more details about the new software.
G	Wi-Fi	This icon appears if a Wi-Fi network is connected.
H	Wi-Fi in Range	An available Wi-Fi network is within range.
I	Signal Strength	This icon displays the phone and roaming signal strength.
J	Text Message	This icon displays when you receive a text message on your phone.
K	911 Assist Off	This icon displays when 911 Assist is set to off and your phone is connected to SYNC.
L	In-Call	This icon displays when a phone call is active.
M	Bluetooth	This icon displays to show an active Bluetooth connection.

Messages may also appear in the status bar to provide you with notifications. You can select the message to view the associated feature.

### Feature Bar

Feature Bar Item	Functions
Audio	Allows you to control the media playing in your vehicle. You can control all audio features including AM, FM and satellite radio, CDs, and media streaming over a Bluetooth device or through a USB connection.
Climate	Allows you to adjust the temperature, fan speed and airflow within the vehicle.
Phone	Allows you to make calls, receive calls, and access the phonebook of your connected device.



## SYNC™ 3 (If Equipped)

Feature Bar Item	Functions
Navigation (If equipped)	Allows you to see your vehicle's location on a virtual road map, get driving directions to your destination and find points of interest along your route.
Apps	Connect and control SYNC 3 compatible apps running on your iPhone or Android device. Also, access built-in additional features such as SiriusXM Traffic and Travel Link (if equipped).
Settings	You can customize your system with various settings for the touchscreen display, feature preferences, and how you want to interact with your vehicle.

### Cleaning the Touchscreen

You can remove fingerprints with a dry, clean, soft cloth.

If dirt or fingerprints are still on the screen, apply a small amount of alcohol to the cloth and try to clean it again.

**Note:** Do not use detergent or any type of solvent to clean the touchscreen.

**Note:** Do not pour or spray alcohol onto the touchscreen.

### Using Voice Recognition

Using voice commands allows you to keep your hands on the wheel and focus on what is in front of you. The system provides feedback through audible tones, prompts, questions and spoken confirmations depending on the situation and the chosen level of interaction (voice settings).

The system also asks short questions (confirmation prompts) when it is not sure of your request or when there are multiple possible responses to your request.

When using voice commands, words and icons may appear in the status bar indicating the status of the voice command session. See **Using Voice Recognition** (page 510).

### Using the Steering Wheel Controls

Depending on your vehicle and option package, you can use different controls on your steering wheel to interact with the touchscreen system in different ways.

**VOL:** Control the volume of audio output.

**Mute:** Mute the audio output.

**Voice:** Press to start a voice session. Press again to stop the voice prompt and immediately begin speaking. Press and hold to end a voice session.

#### SEEK NEXT:

- While in radio mode, press to seek between memory presets.
- While in USB, Bluetooth Audio or CD mode, press to seek between songs or press and hold to fast seek.

## SEEK PREVIOUS:

- While in radio mode, press to seek between memory presets.
- While in USB, Bluetooth Audio or CD mode, press to seek between songs or press and hold to fast seek.

**PHONE ACCEPT:** Press to answer a call or switch between calls.

**PHONE REJECT:** Press to end a call or reject an incoming call.

**Note:** *On some models, **SEEK NEXT** may be combined with **PHONE REJECT** and **SEEK PREVIOUS** may be combined with **PHONE ACCEPT**.*

**M:** Touch the control repeatedly to switch between media sources (modes).

See **Steering Wheel** (page 82).

## Using Your Bezel Controls

Depending on your vehicle and option package, you may also have these controls on your instrument panel:

- **Power:** Switch the audio system on and off.
- **VOL:** Control the volume of playing audio.
- **Seek** and **Tune:** Use as you normally would in audio modes.
- **Eject:** Eject a CD from the audio system.
- **SOURCE** or **MEDIA:** Press repeatedly to advance through available media modes.
- **SOUND:** Press to access the Sound menu where you can adjust sound and other audio settings.
- **1-6:** Press and hold to store or press to select an AM, FM or SIRIUS memory preset. See **Audio System** (page 445).

- **DISP:** Switch the display on or off. You can also touch the screen to switch the display back on.
- **Temperature, fan and climate control buttons:** Control the temperature, fan speed or settings of the climate control system. See **Climate Control** (page 146).

## 911 Assist

### WARNINGS



Unless the 911 Assist setting is set on before a crash, the system will not dial for help which could delay response time, potentially increasing the risk of serious injury or death after a crash.



Do not wait for 911 Assist to make an emergency call if you can do it yourself. Dial emergency services immediately to avoid delayed response time which could increase the risk of serious injury or death after a crash. If you do not hear 911 Assist within five seconds of the crash, the system or phone may be damaged or non-functional.



Always place your phone in a secure location in your vehicle so it does not become a projectile or get damaged in a crash. Failure to do so may cause serious injury to someone or damage the phone which could prevent 911 Assist from working properly.

**Note:** *The SYNC 911 Assist feature must be set on before the incident.*

**Note:** *The SYNC 911 Assist feature only operates in the U.S., Canada or in a territory in which 911 is the emergency number.*

**Note:** *Before setting this feature on, make sure that you read the 911 Assist Privacy Notice later in this section for important information.*

## SYNC™ 3 (If Equipped)

**Note:** If any user sets 911 Assist to on or off, that setting applies for all paired phones. If 911 Assist is switched off and the phone is connected to SYNC, an icon displays on the status bar.

**Note:** Every phone operates differently. While SYNC 911 Assist works with most cellular phones, some may have trouble using this feature.

If a crash deploys an airbag (excluding knee airbags and rear inflatable safety belts [if equipped]) or activates the fuel pump shut-off, your SYNC-equipped vehicle may be able to contact emergency services by dialing 911 through a paired and connected Bluetooth-enabled phone. You can learn more about the 911 Assist feature, by visiting:

Website
<a href="http://www.owner.ford.com">www.owner.ford.com</a> <a href="http://www.syncmyride.ca">www.syncmyride.ca</a> <a href="http://www.syncmaroute.ca">www.syncmaroute.ca</a>

See **Supplementary Restraints System** (page 46). Important information about airbag deployment is in this chapter.

See **Roadside Emergencies** (page 303). Important information about the fuel pump shut-off is in this chapter.

To switch 911 Assist on and off please view the settings information. See **Settings** (page 546).

To make sure that 911 Assist works correctly:

- SYNC must be powered and working properly at the time of the incident and throughout feature activation and use.
- The 911 Assist feature must be set on before the incident.
- You must pair and connect a Bluetooth-enabled and compatible cell phone to SYNC.

- A connected Bluetooth-enabled phone must have the ability to make and maintain an outgoing call at the time of the incident.
- A connected Bluetooth-enabled phone must have adequate network coverage, battery power and signal strength.
- The vehicle must have battery power and be located in the U.S., Canada or in a territory in which 911 is the emergency number.

### In the Event of a Crash

Not all crashes will deploy an airbag or activate the fuel pump shut-off (the triggers for 911 Assist). If a connected cell phone sustains damage or loses its connection to SYNC during a crash, SYNC will search for and try to connect to a previously paired cell phone; SYNC will then attempt to call the emergency services.

Before making the call:

- SYNC provides a short window of time (about 10 seconds) to cancel the call. If you fail to cancel the call, SYNC attempts to dial 911.
- SYNC says the following, or a similar message: "SYNC will attempt to call 911, to cancel the call, press Cancel on your screen or press and hold the phone button on your steering wheel."

If you do not cancel the call, and SYNC makes a successful call, a pre-recorded message plays for the 911 operator, and then the occupant(s) in your vehicle is able to talk with the operator. Be prepared to provide your name, phone number and location immediately, because not all 911 systems are capable of receiving this information electronically.

# SYNC™ 3 (If Equipped)

## 911 Assist May Not Work If

- Your cellular phone or 911 Assist hardware sustains damage in a crash.
- The vehicle's battery or the SYNC system has no power.
- The phone(s) thrown from your vehicle are the ones paired and connected to the system.

## 911 Assist Privacy Notice

When you switch on 911 Assist, it may disclose to emergency services that your vehicle has been in a crash involving the deployment of an airbag or activation of the fuel pump shut-off. Certain versions or updates to 911 Assist may also be capable of electronically or verbally disclosing to 911 operators your vehicle location or other details about your vehicle or crash to assist 911 operators to provide the most appropriate emergency services. If you do not want to disclose this information, do not switch the feature on.

## Safety Information

### WARNING



Driving while distracted can result in loss of vehicle control, crash and injury. We strongly recommend that you use extreme caution when using any device that may take your focus off the road. Your primary responsibility is the safe operation of your vehicle. We recommend against the use of any hand-held device while driving and encourage the use of voice-operated systems when possible. Make sure you are aware of all applicable local laws that may affect the use of electronic devices while driving.

- Do not attempt to service or repair the system. Have an authorized dealer check your vehicle.
- Do not operate playing devices if the power cords or cables are broken, split or damaged. Place cords and cables out of the way, so they do not interfere with the operation of pedals, seats, compartments or safe driving abilities.
- Do not leave playing devices in your vehicle during extreme conditions as it could cause them damage. See your device's user guide for further information.
- For your safety, some SYNC 3 functions are speed-dependent. Their use is limited to when your vehicle is traveling at speeds under 3 mph (5 km/h). Make sure that you review your device's manual before using it with SYNC 3.

## Speed-restricted Features

Some features of this system may be too difficult to use while your vehicle is moving so they are restricted from use unless your vehicle is stationary.

- Screens crowded with information, such as Point of Interest reviews and ratings, SiriusXM Traffic and Travel Link sports scores, movie times or ski conditions.
- Any action that requires you to use a keyboard is restricted, such as entering a navigation destination or editing information.
- All lists are limited so the user can view fewer entries (such as phone contacts or recent phone call entries).

See the following table for more specific examples.

## SYNC™ 3 (If Equipped)

<b>Restricted features</b>	
Cellular Phone	Pairing a Bluetooth phone.
	Browsing of list entries is limited for phone contacts and recent phone calls.
System Functionality	Editing the keypad code.
	Enabling Valet Mode.
	Editing settings while the rear view camera or active park assist are active.
Wi-Fi	Editing Wi-Fi settings.
	Editing the list of wireless networks.
	Connecting to a new Wi-Fi network.
Text Messages	Viewing received text messages.
Navigation	Using the keyboard to enter a destination.
	Adding or editing Navigation Favorites entries or Avoid Areas.

### Creating a SYNC Owner Account

Why do I need a SYNC owner account?

- Essential for keeping up with the latest software and connected features.
- Access to customer support for any questions you may have.
- Maintain account permissions.

Visit the website to sign up and register.

<b>Website</b>
<a href="http://www.owner.ford.com">www.owner.ford.com</a> <a href="http://www.syncmyride.ca">www.syncmyride.ca</a>

<b>Website</b>
<a href="http://www.syncmaroute.ca">www.syncmaroute.ca</a>

### SYNC Connect with Ford Pass (If Equipped)

With a SYNC Connect-equipped vehicle, you can use Ford Pass to track your vehicle's location and remotely access vehicle features such as start, lock and unlock and vehicle status including fuel level and approximate mileage. You can also schedule specific times to remotely start your vehicle so it's ready to hit the road as soon as you are. Ford Pass is available through a free download via the Apple App Store® or Google Play™. Message and data rates may apply. Services may be limited by mobile phone network coverage area.

## Updating Your System

You can choose to download the update onto a USB drive or use Wi-Fi to deliver automatic updates.

### USB Updates

To use the USB update you need to log into your owner account and visit the SYNC software update page.

Website
www.owner.ford.com www.syncmyride.ca www.syncmaroute.ca

The website notifies you if an update is available. You can then select to download the update.

You will need an empty USB drive. Please check the website for minimum requirements. Once you have inserted the USB drive into your computer, choose to start the download. Follow the instructions provided to download the files to the USB drive.

The installation of most files occurs in the background, and does not interrupt your use of the system. Navigation updates cannot be installed in the background, because the files are too large.

To install the update in your vehicle, remove anything that is plugged in the USB ports on the media hub and plug in the USB drive containing the update. When the USB drive is plugged in, the installation should begin immediately. After a successful installation, the update is available the next time the vehicle is started.

Please refer to the website for any further actions.

## Updating Over Wi-Fi

To update your System over Wi-Fi your vehicle must be connected to a Wi-Fi access point. Data rates may apply.

### To connect your system to Wi-Fi, select:

Menu Item	
Settings	
Wi-Fi	
Available Wi-Fi Networks	You can then select your Wi-Fi network. You may have to enter the security code if the network is secured. The system confirms when it has connected to the network.

You must also give the system permission to update automatically. Upon vehicle delivery, the System asks you if you would like to use the automatic update feature. If you agree to automatic updates, you can press OK to confirm. If this selection does not appear upon vehicle delivery you can access it through the General Settings. See **Settings** (page 546). You can also perform a master reset. See **SYNC™ 3 Troubleshooting** (page 560).

## If you would like to switch this feature on later, select:

Menu Item	
Settings	
General	
Automatic System Updates	From this menu, you can enable automatic updates. If you already are not currently connected to Wi-Fi access point, the system prompts you to set up a Wi-Fi connection when you enable this feature.

When the system is connected via Wi-Fi and automatic updates are enabled, your system checks for software updates periodically. If a new version is available, it downloads at that time. Software downloads can take place for up to 30 minutes after you have switched your vehicle off. The updates do not interrupt the normal use of your SYNC 3 system. If a download does not complete for any reason, the download continues where it left off at the next Wi-Fi connected opportunity. Upon activation of an update, a banner displays on the touchscreen indicating the system update. Select the icon to see more detail. This icon displays for two ignition cycles.

## To switch this feature off:

Menu Item	
Settings	
General	
Automatic System Updates	In this menu selection, you can change the selection for automatic updates to OFF.

## Support

The SYNC support team is available to help you with any questions you are not able to answer on your own.

Monday-Saturday, 8:30am-8:00pm EST.

### For Ford:

United States: 1-800-392-3673.

Canada: 1-800-565-3673.

Times are subject to change due to holidays.

## Privacy Information

When you connect a cellular phone to SYNC 3, the system creates a profile within your vehicle that links to that cellular phone. This profile helps in offering you more cellular features and operating more efficiently. Among other things, this profile may contain data about your cellular phone book, text messages (read and unread), and call history, including history of calls when your cell phone was not connected to the system. In addition, if you connect a media device, the system creates and retains an index of supported media content. The system also records a short diagnostic log of approximately 10 minutes of all recent system activity. The log profile and other system data may be used to improve the system and help diagnose any problems that may occur.

The cellular profile, media device index, and diagnostic log remain in your vehicle unless you delete them and are generally accessible only in your vehicle when the cellular phone or media player is connected.

If you no longer plan to use the system or your vehicle, we recommend you perform a Master Reset to erase all stored information. You can find more information about the Master Reset in General Settings. See **Settings** (page 546). System

## SYNC™ 3 (If Equipped)

data cannot be accessed without special equipment and access to your vehicle's SYNC 3 module. Ford Motor Company and Ford of Canada do not access the system data for any purpose other than as described absent consent, a court order,

or where required by law enforcement, other government authorities, or other third parties acting with lawful authority. Other parties may seek to access the information independently of Ford Motor Company and Ford of Canada.

### HOME SCREEN



E205446

Item	Tile	Home screen display
A	Audio	Shows the active media source.



## SYNC™ 3 (If Equipped)

Item	Title	Home screen display
		If your vehicle does not have navigation, this space contains the compass.
B	Phone	The name of the connected phone appears on the screen. The status of the phone features also appear. This includes signal strength, battery charge, 911 assist setting state (On or Off), text messaging and roaming.
C	Navigation <sup>1</sup>	This map displays your current location or current route in real time. When you have navigation active, you also see the next turn and the length of time and distance to your destination. If your vehicle does not have navigation, this space contains the audio information.

<sup>1</sup> If equipped.

You can touch any of the feature displays to access that feature.

Anytime you select the home button, the system returns you to this screen.

### USING VOICE RECOGNITION

The SYNC 3 system allows you to use voice commands, to control features like audio and climate controls. By using voice commands, you can keep your hands on the wheel and your eyes on the road.

You can access each feature controlled by SYNC 3 through a variety of commands.



To activate the SYNC 3 voice commands push the voice button on the steering wheel and wait for the prompt.

\_\_\_ is a dynamic listing, meaning that it can be the name of anything, such as artist, the name of contact or number. The context and the description of the command tell you what to say for this dynamic option.

There are some commands that work for every feature, these commands are:

Voice Command	Action and Description
Main Menu	Brings you to the main menu.
Go back	Returns you to the previous screen.
Cancel	Ends the voice session.
List of Commands	Gives you a list of possible voice commands.
___ List of Commands	You can name any feature and the system gives a list of commands available for the feature. For example, you could say:

## SYNC™ 3 (If Equipped)

Voice Command	Action and Description
	Phone List of Commands
	Navigation List of Commands
Next Page	You can use this command to view the next page of options on any screen where multiple pages of choices are given.
Previous Page	You can use this command to view the previous page of options on any screen where multiple pages of choices are given.
Help	Gives you available commands you can use on the current screen.

Included here are some of the most popular commands for each SYNC 3 feature.

### Audio Voice Commands

\_\_\_ is a dynamic listing, meaning that for audio voice commands it can be the name of a Sirius channel or a channel number, a radio frequency number, or the name of an artist, album, song or a genre.

**To control the media features, press the voice button and when prompted, say:**

Voice command	Description
Sirius Channel ___ <sup>1</sup>	You can say the Sirius channel name or number such as "Sirius channel 16".
You can also turn to a Sirius channel by saying the channel's name, such as "The Pulse".	
AM ___ FM ___	Allows you to tune to a specific FM or AM frequency such as "FM 88.7" or "AM 1580".
FM ___ HD ___ <sup>1</sup>	Allows you to tune to a specific HD frequency such as "FM 88.7 HD 1".
Bluetooth Audio	Allows you to listen to music on your Bluetooth-connected device.
USB	Allows you to listen to music on your USB connected device.
Play Genre ___ Play Playlist ___ Play Artist ___ Play Album ___	For USB audio only, you can say the name of an artist, album, song or a genre to listen to that selection. Your system must finish indexing before this option is available. For example, you could say "Play artist, The Beatles" or "Play song, Penny Lane".

## SYNC™ 3 (If Equipped)

Voice command	Description
Play Podcast ___ Play Song ___ Play Audiobook ___	
Browse ___	For USB audio only, you can say the name of an artist, album, or a genre to browse by that selection. Your system must finish indexing before this option is available. For example you can say "Browse The Beatles" or "Browse folk".

<sup>1</sup> This option may not be available in all markets or may require a subscription.

### Climate Voice Commands

You can control the temperature of the vehicle using voice commands.

\_\_\_ is a dynamic listing, meaning that for climate voice commands it can be the desired degrees for the temperature setting.

#### To adjust the temperature, say:

Voice command	Description
Set Temperature ___	Adjust the temperature between 60–85°F (15.5–29.5°C).

### Phone Voice Commands

#### Pairing a Phone

You can use voice commands to connect your Bluetooth enabled phone to the system.

#### To pair your phone, press the voice button and when prompted, say:

Voice command	Description
Pair Phone	Follow the on-screen instructions to complete the pairing process. See <b>Settings</b> (page 546).

### Making Calls

\_\_\_ is a dynamic listing, meaning that for phone voice commands it can be the name of the contact you wish to call or the digits you want to dial.

## SYNC™ 3 (If Equipped)

**Press the voice button and say a command similar to the following:**

Voice command	Description
Call ___	Allows you to call a specific contact from your phonebook such as "Call Jenny".
Call ___ at ___	Allows you to call a specific contact from your phonebook at a specific location such as "Call Jenny at Home".
Dial ___	Allows you to dial a specific number such as "Dial 867-5309".

Please make sure that you are saying the contact name exactly as it appears in your contact list.

**Once you have provided the digits of the phone number, you can say the following commands:**

Voice Command	Description
<0-9>	If the full number was not entered with the first command, you can continue saying the number.
Dial	Tells SYNC 3 to make the phone call.
Delete	Tells SYNC 3 to erase the last block of digits stated.
Clear	Tells SYNC 3 to erase the entire number.

### Text Message Voice Commands

**To access text message options, press the voice button and say:**

Voice command	Description
Listen to Message	
Listen to text message ___	You can say the number of the message you would like to hear.
Reply to Message	

# SYNC™ 3 (If Equipped)

## Navigation Voice Commands (If Equipped)

### Setting a Destination

You can use any of the following commands to set a destination or find a

point of interest.

\_\_\_ is a dynamic listing, meaning that for navigation voice commands it can be a POI category or a major brand name, where major brand name is a chain with more than 20 locations

### You can find an address, a point of interest (POI), or search for points of interest by category:

Voice command	Description
Find an Address	Allows you to enter the address search functionality. You can also search for an address in a specific state or province.
Find a ___	State the name of the POI category or major brand name you would like to search for such as "Find restaurants".
Find a POI	Allows you to enter the POI search functionality.
Find an Intersection	Allows you to enter the intersection search functionality.
Find the Nearest <POI Category>	State the name of a POI category or major brand name you would like to search for.
Show Previous Destinations	Allows you to see a list of your previous destinations.
Show Favorites	Allows you to see a list of your favorite destinations.
Drive Home	Allows you to route to your home address.
Drive to Work	Allows you to route to your work address.

### In addition, you can say these commands when a route is active:

Voice command	Description
Cancel Route	Cancels the current route.
Detour	Allows you to select an alternate route.
Repeat Instruction	Repeats the last guidance prompt.
Show Route	Displays the active route.
Route Summary	Displays the list of upcoming maneuvers.

## SYNC™ 3 (If Equipped)

Voice command	Description
Where Am I	Provides current location.
Zoom in	Allows you to zoom in on the map.
Zoom out	Allows you to zoom out from the map.

### Mobile App Voice Commands (If Equipped)

The following voice commands are always available:

Voice command	Description
Mobile Apps	SYNC 3 will prompt you to say the name of an app to start it on SYNC 3.
List Mobile Apps	SYNC 3 will list all of the currently available Mobile Apps.
Find Mobile Apps	SYNC 3 will search and connect to compatible app(s) running on your mobile device.

There are also voice commands that you can use when app(s) are connected to SYNC 3:

Voice command	Description
Say the name of an app	At any time, you can say the name of a mobile app to start the mobile app on SYNC 3.
Say the name of an app, followed by help	SYNC 3 will list the available voice commands for the specified app if the app is running on SYNC 3.

### SiriusXM Traffic and Travel Link Voice Commands (If Equipped)

SiriusXM Traffic and Travel Link may not be available in all markets. Activation and a subscription are required.

## SYNC™ 3 (If Equipped)

**You can say the following commands to access SiriusXM Traffic and Travel Link:**

Voice command	Description
Show Traffic	Displays a list of traffic incidents.
Show Weather Map	Displays the current weather map.
Show Fuel Prices	Displays a list of fuel prices.
Show 5 Day Forecast	Displays the 5 day weather forecast.
Help	

### Voice Settings Commands

**You can say the following commands to access the voice settings:**

Voice command	Description
Voice Settings	Allows you to enter the voice settings functionality.
Interaction Mode Standard	Sets standard prompting with longer prompts.
Interaction Mode Advanced	Sets advanced prompting with shorter prompts.
Call Confirmation On	Allows the system to confirm before making a phone call.
Call Confirmation Off	The system does not confirm before placing a call.
Voice Command Lists On	The system displays a short list of available commands.
Voice Command Lists Off	The system does not display the list of commands.

You can use the volume control to adjust the volume of the system voice prompts. While prompt is active, adjust the volume control up or down to your desired setting.

**Note:** Depending on the current climate control settings, the fan speed may automatically go down while issuing voice commands or while making and receiving phone calls via SYNC to reduce the amount of background noise in the vehicle. The fan speed will automatically return to normal operation once the voice session ends. Fan speed can also be adjusted normally during a voice session, simply press fan buttons (or turn fan knob) to increase or decrease fan speed to desired setting.

## SYNCTM 3 (If Equipped)

To disable this automatic fan speed reduction feature during voice sessions, press and hold the climate control AC and Recirculated air buttons simultaneously, release and then increase fan speed within 2 seconds. To re-enable this feature, repeat the above sequence.

### ENTERTAINMENT



E205443

Message	Message and description
A	Sources
B	Direct Tune
C	Presets



# SYNC™ 3 (If Equipped)

You can access these options using the touchscreen or voice commands.

## Sources

Press this button to select the source of media you want to listen to.

Menu item	
AM	
FM	
SIRIUS <sup>1</sup>	
CD <sup>1</sup>	
USB	The name of the USB that is plugged in displays here.
Bluetooth Stereo	
Apps	If you have SYNC 3 compatible apps on your connected smart phone, they display here as individual source selections.

<sup>1</sup> This feature may not be available in all markets and requires an active subscription.

## AM/FM Radio

### Tuning a Station

You can use the tune or seek controls on the radio bezel to select a station.

### To tune a station using the touchscreen, select:

Menu item
Direct Tune

A pop up appears, allowing you to type in the frequency of a station. You can only enter a valid station for the source you are currently listening to.

You can press the backspace button to delete the previously entered number.

### Once you have entered the station's call numbers, you can select:

Menu item	Action and description
Enter	Press to begin playing the station you have entered.
Cancel	Press to exit without changing the station.

## Presets

To set a new preset, tune to the station and then press and hold one of the memory preset buttons. The audio mutes briefly while the system saves the station and then returns.

## SYNCTM 3 (If Equipped)

There are two preset banks available for AM and three banks for FM. To access additional presets, tap the preset button. The indicator on the preset button shows which bank of presets you are currently viewing.

### SiriusXM® Satellite Radio (If Activated)

**Note:** *This feature may not be available in all markets and requires an active subscription.*



E234451

SiriusXM satellite radio is a subscription-based satellite radio service that broadcasts a variety of music, sports, news, weather, traffic and entertainment programming. Your factory-installed SiriusXM satellite radio system includes hardware and a limited subscription term that begins on the date of sale or lease of your vehicle. See an authorized dealer for availability.

For more information on extended subscription terms (a service fee is required), the online media player and a list of SiriusXM satellite radio channels, and other features, please visit [www.siriusxm.com](http://www.siriusxm.com) in the United States, [www.siriusxm.ca](http://www.siriusxm.ca) in Canada, or call SiriusXM at 1-888-539-7474.

**Note:** *SiriusXM reserves the unrestricted right to change, rearrange, add or delete programming. This includes canceling, moving or adding particular channels, and its prices, at any time, with or without notice to you. Ford Motor Company shall not be responsible for any such programming changes.*

**Note:** *This receiver includes the eCos real-time operating system. eCos is published under the eCos License.*

### The following buttons are available for SiriusXM:

Menu item	Action and description	
Browse	Touch this button to see a list of available stations.	
Direct Tune	A pop-up appears, allowing you to type in the call numbers of a station. Once you enter the stations call numbers, you can select:	
	Enter	The system tunes to the station you select.
	Cancel	You exit the pop-up and the current station continues to play.
	You can press the backspace button to delete the previous number.	

## SYNC™ 3 (If Equipped)

Menu item	Action and description	
Replay	Replay audio on the current channel. You can replay approximately 45 minutes of audio as long as you remain tuned to the current station. Changing stations erases the previous audio.	
	Live	When you are in replay mode, you are not able to select a different preset until you return to live audio. Pressing this button returns you to the live broadcast.
ALERT	Save the current song, artist, or team as a favorite. The system alerts you when it plays again on any channel. Selecting this button allows you to enable and edit alerts. See <b>Settings</b> (page 546).	

### Memory Presets

To set a preset, tune to the station then press and hold one of the memory preset buttons. The audio mutes briefly while the system saves the station and returns once the station is stored.

There are three preset banks available for SiriusXM. To access additional presets, tap the preset button. The indicator on the preset button shows which bank of presets you are currently viewing.

### Satellite Radio Electronic Serial Number (ESN)

You need your ESN to activate, modify or track your satellite radio account. See **Settings** (page 546).

### SiriusXM Satellite Radio Reception Factors and Troubleshooting

Potential reception issues	
Antenna obstructions	For optimal reception performance, keep the antenna clear of snow and ice build-up and keep luggage and other materials as far away from the antenna as possible.
Terrain	Hills, mountains, tall buildings, bridges, tunnels, freeway overpasses, parking garages, dense tree foliage and thunderstorms can interfere with your reception.
Station overload	When you pass a ground-based broadcast-repeating tower, a stronger signal may overtake a weaker one and the audio system may mute.
Satellite radio signal interference	Your display may show ACQUIRING... to indicate the interference and the audio system may mute.

## SYNCTM 3 (If Equipped)

<b>Troubleshooting tips</b>		
<b>Message</b>	<b>Cause</b>	<b>Action</b>
Acquiring Signal	Radio requires more than two seconds to produce audio for the selected channel.	No action required. This message should disappear shortly.
Satellite antenna fault SIRIUS system failure	There is an internal module or system failure present.	If this message does not clear shortly, or with an ignition key cycle, your receiver may have a fault. See an authorized dealer for service.
Invalid Channel	The channel is no longer available.	Tune to another channel or choose another preset.
Unsubscribed Channel	Your subscription does not include this channel.	Contact SiriusXM at 1-888-539-7474 to subscribe to the channel, or tune to another channel.
Satellite acquiring signal...	The signal is lost from the SiriusXM satellite or SiriusXM tower to your vehicle antenna.	The signal is blocked. When you move into an open area, the signal should return.
Updating...	Update of channel programming in progress.	No action required. The process may take up to three minutes.
Questions? Call 1-888-539-7474	Your satellite service is no longer available.	Contact SiriusXM at 1-888-539-7474 to resolve subscription issues.
None found. Check channel guide.	All the channels in the selected category are either skipped or locked.	Use the channel guide to turn off the Lock or Skip function on that station.
SIRIUS Subscription updated	SiriusXM has updated the channels available for your vehicle.	No action required.

### **HD Radio™ Information (If Available)**

**Note:** *This feature may not be available in all markets.*

To activate HD radio, please see the Radio Settings in the Settings Chapter. See **Settings** (page 546).

**Note:** *HD Radio broadcasts are not available in all markets.*

## SYNC™ 3 (If Equipped)

HD Radio technology is the digital evolution of analog AM/FM radio. Your system has a special receiver that allows it to receive digital broadcasts (where available) in addition to the analog broadcasts, it already receives. Digital broadcasts provide a better sound quality than analog broadcasts with free, crystal-clear audio and no static or distortion. For more information, and a guide to available stations and programming, please visit:

<b>Website</b>
<a href="http://www.hdradio.com">www.hdradio.com</a>

When HD Radio is on and you tune to a station broadcasting HD Radio technology, you may notice the following indicators on your screen:



E142616

### When HD Radio broadcasts are active, you can access the following functions:

Message	Action and description
Presets	Allows you to save an active channel as a memory preset. Touch and hold a memory preset slot until the sound returns. There is a brief mute while the radio saves the station. Sound returns when the channel saves. When switching to an HD2 or HD3 memory preset, the sound mutes before the digital audio plays, because the system has to reacquire the digital signal.

**Note:** As with any station you save, you cannot access the saved station if your vehicle is outside the station's reception area.

The HD logo is grey when acquiring a digital station, and then changes to orange when digital audio is playing. When this logo is available, you may also see Title and Artist fields on-screen.

The multicast indicator appears in FM mode (only) if the current station is broadcasting multiple digital broadcasts. The highlighted numbers signify available digital channels where new or different content is available. HD1 signifies the main programming status and is available in analog and digital broadcasts. Other multicast stations (HD2 through HD7) are only available digitally.

**Note:** There is also an additional feature for stations that have more than 1 HD multicast (For example, HD1 or HD2). The HD logo and Radio text appears as a button. Pressing this button allows you cycle through all of the HD stations on that specific frequency. For example, if you are on 101.1 and it has HD1, HD2, HD3, pressing the button repeatedly causes the radio to cycle through the HD stations in a cyclic increasing order.

## SYNCTM 3 (If Equipped)

### HD Radio Reception and Station Troubleshooting

<b>Potential reception issues</b>	
Reception area	<p>If you are listening to a multicast station and you are on the fringe of the reception area, the station may mute due to weak signal strength.</p> <p>If you are listening to HD1, the system changes back to the analog broadcast until the digital broadcast is available again. However, if you are listening to any of the possible HD2-HD7 multicast channels, the station mutes and stays muted unless it is able to connect to the digital signal again.</p>
Station blending	<p>When the system first receives a station (aside from HD2-HD7 multicast stations), it first plays the station in the analog version. Once the receiver verifies the station is an HD Radio station, it shifts to the digital version. Depending on the station quality, you may hear a slight sound change when the station changes from analog to digital. Blending is the shift from analog to digital sound or digital back to analog sound.</p>

In order to provide the best possible experience, use the contact form to report any station issues found while listening to a station broadcasting with HD Radio technology. Independent entities own and operate each station. These stations are responsible for ensuring all audio streams and data fields are accurate.

<b>Potential station issues</b>		
<b>Issues</b>	<b>Cause</b>	<b>Action</b>
Echo, stutter, skip or repeat in audio. Increase or decrease in audio volume.	This is poor time alignment by the radio broadcaster.	No action required. This is a broadcast issue.
Sound fading or blending in and out.	The radio is shifting between analog and digital audio.	No action required. The reception issue may clear up as you continue to drive.
There is an audio mute delay when selecting HD2 or HD3, multicast preset or Direct Tune.	The digital multicast is not available until the HD Radio broadcast is decoded. Once decoded, the audio is available.	No action required. This is normal behavior. Wait until the audio is available.

## SYNC™ 3 (If Equipped)

Potential station issues		
Issues	Cause	Action
Cannot access HD2 or HD3 multicast channel when recalling a preset or from a direct tune.	The previously stored multicast preset or direct tune is not available in your current reception area.	No action required. The station is not available in your current location.
Text information does not match currently playing audio.	Data service issue by the radio broadcaster.	Fill out the station issue form. <sup>1</sup>
There is no text information shown for currently selected frequency.	Data service issue by the radio broadcaster.	Fill out the station issue form. <sup>1</sup>

<sup>1</sup> You can find the form here:

Website
<a href="http://hdradio.com/stations/feedback">http://hdradio.com/stations/feedback</a>

HD Radio Technology manufactured under license from iBiquity Digital Corporation and foreign patents. HD Radio and the HD and HD Radio logos are proprietary trademarks of DTS. Ford Motor Company and DTS are not responsible for the content sent using HD Radio technology. Content may be changed, added or deleted at any time at the station owner's discretion.

### CD (If equipped)

Once you select this option, the system returns you to the main audio screen.

The current audio information appears on the screen.

### The following buttons are also available:

Button	Function
Browse	You can use the browse button to select a track.
Repeat	Select this button and a small number one displays to indicate the track is set to repeat.

## SYNC™ 3 (If Equipped)

Button	Function
	For MP3 CDs, this button allows you to toggle through repeat off, repeat one track (a small number one displays), and repeat current folder (a small folder displays).
Shuffle	Select the shuffle symbol to have the audio on the disk play in random order.

You can use the forward, reverse, pause or play buttons to control the audio playback.

### Bluetooth Stereo or USB

Bluetooth Stereo and USB allow you to access media that you store on your Bluetooth device or USB device such as music, audio books or podcasts.

### The following buttons are available for Bluetooth and USB:

Button	Function
Repeat	Pressing the repeat button toggles the repeat setting through three modes: repeat off (button not highlighted), repeat all (button highlighted) and repeat track (button highlighted with a small number one).
Shuffle	Play the tracks in random order.

You can use the forward, reverse, pause or play buttons to control the audio playback.

To get more information about the currently playing track, press the cover art or Info button.

For some devices, SYNC 3 is able to provide 30-second skip buttons when you listen to audio books or podcasts. These buttons allow you to skip forward or backward within a track.

While playing audio from a USB device you can look for certain music by selecting the following:

Button	Function
Browse	If available, displays the list of tracks in the Now Playing playlist.
New Search	This option, which is available under browse, allows you to play all tracks or to filter the available media into one of the below categories.
	Play All



## SYNC™ 3 (If Equipped)

Button	Function
	Playlists
	Artist
	Albums
	Songs
	Genres
	Podcasts
	Audio books
	Composers
A-Z Jump	This button allows you to choose a specific letter to view within the category you are browsing.
Explore Device	If available, this allows you to browse the folders and files on your USB device.

### USB Ports



E211463

The USB ports are in the center console or behind a small access door in the instrument panel.

This feature allows you to plug in USB media devices, memory sticks, flash drives or thumb drives, and charge devices if they support this feature.

Select this option to play audio from your USB device.

### Apps

The system supports the use of certain audio apps such as iHeartRadio through a USB or bluetooth-enabled device.

Each app gives you different on-screen options depending on the app's content. See **Apps** (page 543).

### Supported Media Players, Formats and Metadata Information

The system is capable of hosting nearly any digital media player, including iPod, iPhone, and most USB drives.

Supported audio formats include MP3, WMA, WAV, AAC, and FLAC.

Supported audio file extensions include MP3, WMA, WAV, M4A, M4B, AAC, and FLAC.

## SYNC™ 3 (If Equipped)

Supported USB file systems include: FAT, exFAT, and NTFS.

SYNC 3 is also able to organize the media from your USB device by metadata tags. Metadata tags, which are descriptive software identifiers embedded in the media files, provide information about the file.

If your indexed media files contain no information embedded in these metadata tags, SYNC 3 may classify the empty metadata tags as unknown.

SYNC 3 is capable of indexing up to 50,000 songs per USB device, for up to 10 devices.

## CLIMATE

Touch the climate button on the touchscreen to access your climate control features. Depending on your vehicle line and option package, your climate screen may look different from one of the screens shown below. Your screen may not contain all of the features shown.

**Note:** You can switch temperature units between Fahrenheit and Celsius. See **Settings** (page 546).

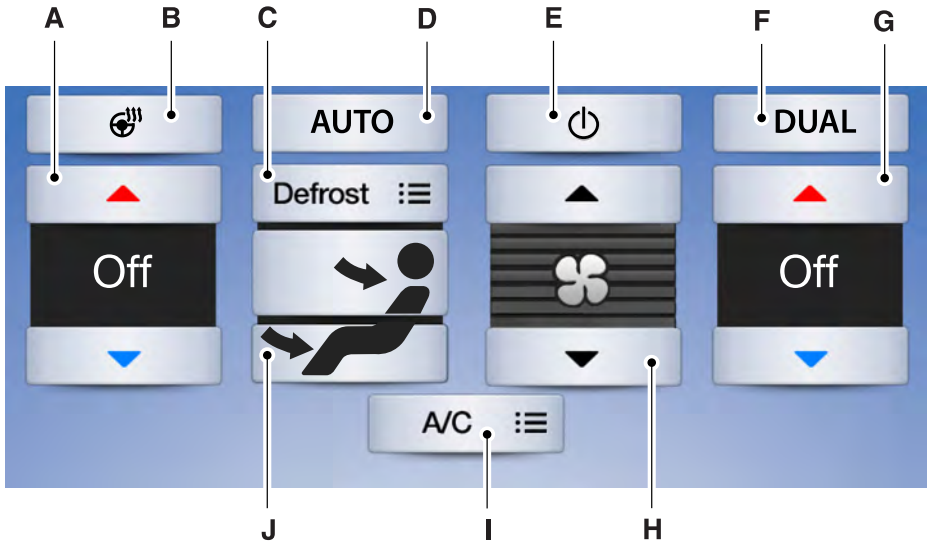

E206820

## SYNC™ 3 (If Equipped)

- A **Driver temperature:** Touch up or down to adjust the temperature.
- B **Heated steering wheel:** Touch this icon to switch the heated steering wheel on and off. It takes about 5 minutes to warm the steering wheel to 74°F (23°C) in temperatures as low as -4°F (-22°C). The wheel maintains an approximate temperature of 90°F (32°C) and operates independently from the heated seats and other climate-control functions. The heating element is in between the leather covering and foam core to help provide maximum heat without adversely affecting the feel of the steering wheel.
- Note:** This feature only functions when you switch the engine on.
- Note:** The heated steering wheel may remain on after remote starting the vehicle, based on your remote start settings. The heated steering wheel may also turn on when you start your vehicle, if it was on when you switched your vehicle off.
- Note:** For steering wheels with wood trim, the heating feature will not heat the wheel between the 10 and 2 o'clock positions.
- C **Defrost:** A pop up appears on the screen to display the defrost options.
- MAX Defrost:** Touch the button to maximize defrosting. Air flows through the windshield vents, the fan automatically adjusts to the highest speed and the driver and passenger temperatures are set to HI. You can use this setting to defog or clear a thin covering of ice from the windshield. The heated rear window also automatically turns on when you select MAX Defrost.
- Defrost:** Distributes air through the windshield defroster vents and demister vents.
- D **AUTO:** Touch the button to switch on automatic operation. Select the desired temperature using the temperature control. The system adjusts fan speed, air distribution, air conditioning operation, and selects outside air or recirculated air to heat or cool the vehicle in order to maintain the desired temperature.
- E **Power:** Touch the button to switch the system on and off. Switching off the climate control system prevents outside air from entering the vehicle.
- F **DUAL:** This button lights up when the passenger controls are active. To switch it off and link the passenger temperature to the driver temperature, touch the DUAL button.
- Note:** the passenger side temperature and the DUAL indication automatically turn on when you or your passenger adjust the passenger temperature.
- G **Passenger temperature:** Touch up or down to adjust the temperature.
- H **Fan speed:** Touch up or down to increase or decrease the volume of air that circulates in your vehicle.

**Note:** You cannot adjust the fan speed when the system is set to AUTO or MAX A/C.

**A/C:** A pop-up appears on the screen to display the air conditioning options.

**MAX A/C:** Touch the button to activate and maximize cooling. The driver and passenger temperatures are set to LO, recirculated air flows through the instrument panel vents, air conditioning automatically turns on and the fan automatically adjusts to the highest speed.

**A/C:** Touch to switch the air conditioning on or off. Use A/C with recirculated air to improve cooling performance and efficiency.

**Note:** In certain conditions (for example, Max Defrost), the air conditioning compressor may continue to operate even when you switch the air conditioning A/C button off.

**Recirculated air:** Touch to switch the recirculated air on or off. When recirculated air is on, it may reduce the amount of time needed to cool down the interior (when used with A/C) and help reduce odors from reaching the interior.

**Note:** Recirculated air may turn off automatically (or the system may not allow Recirculated air to turn on) in all airflow modes except MAX A/C to reduce risk of fogging. It may also turn on and off automatically in Panel or Panel/Floor airflow modes during hot weather in order to improve cooling efficiency.

**J Manual airflow distribution controls:** Select these controls individually, together, or with Defrost to direct the air flow to the area you desire.

**Panel:** Distributes air through the instrument panel vents.

**Floor:** Distributes air through the demister vents, floor vents and rear seat floor vents.

## PHONE

### WARNING



Driving while distracted can result in loss of vehicle control, crash and injury. We strongly recommend that you use extreme caution when using any device that may take your focus off the road. Your primary responsibility is the safe operation of your vehicle. We recommend against the use of any hand-held device while driving and encourage the use of voice-operated systems when possible. Make sure you are aware of all applicable local laws that may affect the use of electronic devices while driving.

Hands-free calling is one of the main features of the system. Once you pair your cell phone, you can access many options using the touchscreen or voice commands. While the system supports a variety of features, many are dependent on your cell phone's functionality.

### Pairing Your Cell Phone for the First Time

Pair your Bluetooth enabled phone with the system before using the functions in hands-free mode.

## SYNC™ 3 (If Equipped)

Switch on Bluetooth on your device to begin pairing. See your phone's manual if necessary.

### To add a phone, select:

Menu Item
Add Phone

1. Follow the on-screen instructions.
2. A prompt alerts you to search for the system on your phone.
3. Select your vehicle's make and model as it displays on your phone.
4. Confirm that the six-digit number appearing on your phone matches the six-digit number on the touchscreen.
5. The touchscreen indicates when the pairing is successful.
6. Your phone may prompt you to give the system permission to access information. To check your phone's compatibility, see your phone's manual or visit the website.

### Alternatively, to add a phone, select:

Menu Item
Add Phone
<b>Then select:</b>
Discover Other Bluetooth Devices

1. Follow the on-screen instructions.
2. Select your phone's name when it appears on the touchscreen.

3. Confirm that the six-digit number appearing on your phone matches the six-digit number on the touchscreen.
4. The touchscreen indicates when the pairing is successful.
5. Your phone may prompt you to give the system permission to access information. To check your phone's compatibility, see your phone's manual or visit the website.

At a minimum, most cell phones with Bluetooth wireless technology support the following functions:

- Answering an incoming call.
- Ending a call.
- Dialing a number.
- Call waiting notification.
- Caller identification.

Other features, such as text messaging using Bluetooth and automatic phonebook download, are phone-dependent features.

### To check your phone's compatibility, see your phone's manual or visit the website:

Websites
owner.ford.com www.syncmyride.ca www.syncmaroute.ca

### Phone Menu

This menu becomes available after pairing a phone.

## SYNCTM 3 (If Equipped)

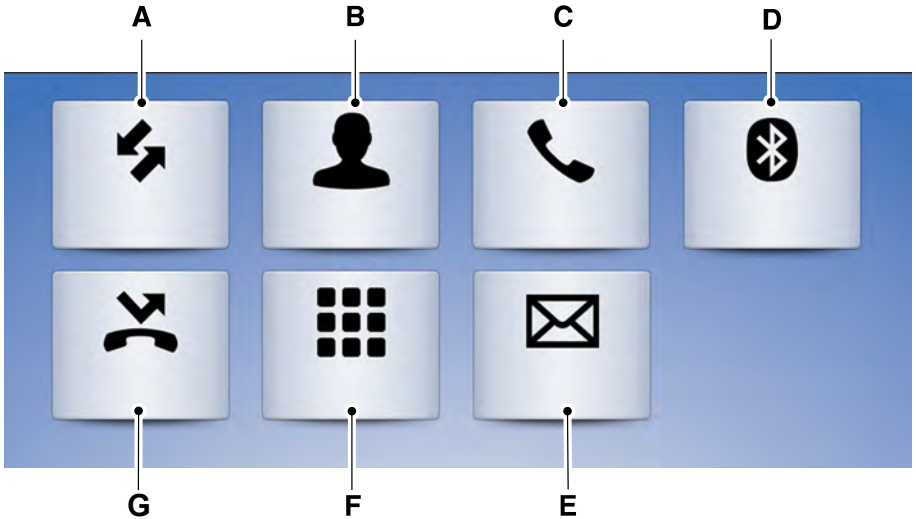

E251249

Item	Menu Item	Action and Description			
A	Recent Call List	Displays your recent calls. You can place a call by selecting an entry from this list. You can also sort the calls by selecting the drop down menu at the top of the screen. You can choose:			
		All	Incoming	Outgoing	Missed
B	Contacts	All of your contacts from your phone display in alphabetical order.			
		A-Z Jump		Selecting this button allows you to choose a specific letter to view.	
C	Phone Settings	Displays the name of your phone and takes you to the phone settings options. From this menu, you can pair subsequent devices, set ring tones and alerts.			

## SYNC™ 3 (If Equipped)

Item	Menu Item	Action and Description
D	Change Device	Gives you access to the list of paired or connected Bluetooth devices allowing you to change or select a device.
E	Text Messages	Displays all recent text messages.
F	Phone Keypad	Use this keypad to dial in a phone number. Use the backspace button to delete numbers.
		Call
G	Do Not Disturb	Touch this button to reject all incoming calls automatically. Text message notifications do not display on the screen. All ringtones and alerts are set to silent.

Users with phones having voice services may see a button to access the feature. For example, iPhone users see a Siri button. A press and hold of the voice button on the steering wheel also accesses this feature.

### Making Calls

There are many ways to make calls from the SYNC 3 system, including using voice commands. See **Using Voice Recognition** (page 510). You can use the touchscreen to place calls as well.

**To call a number in your contacts, select:**

Menu Item	Action and Description
Contacts	You can then select the name of the contact you want to call. Any numbers stored for that contact display along with any stored contact photos. You can then select the number that you want to call. The system begins the call.

**To call a number from your recent calls, select:**

Menu Item	Action and Description
Recent Call List	You can then select an entry that you want to call. The system begins the call.

**To call a number that is not stored in your phone, select:**

Menu Item	Action and Description
Phone Keypad	Select the digits of the number you wish to call.
Call	The system begins the call.

Pressing the backspace button deletes the last digit you typed.

## Receiving Calls

During an incoming call, an audible tone sounds. Caller information appears in the display if it is available.

**To accept the call, select:**

Menu Item
Accept

**Note:** You can also accept the call by pressing the phone button on the steering wheel.

**To reject the call, select:**

Menu Item
Reject

**Note:** You can also reject the call by pressing the phone button on the steering wheel.

Ignore the call by doing nothing. SYNC 3 logs it as a missed call.

## During a Phone Call

During a phone call, the contacts name and number display on the screen along with the call duration.

The phone status items are also visible:

- Signal Strength.
- Battery.
- 911 Assist (United States and Canada only). See **Settings** (page 546).

You can select any of the following during an active phone call:



## SYNC™ 3 (If Equipped)

Item	
End Call	Immediately end a phone call. You can also press the button on the steering wheel.
Keypad	Press this to access the phone keypad.
Mute	You can switch the microphone off so the caller does not hear you.

Item	
Privacy	Transfer the call to the cell phone or back to SYNC 3.

### Text Messaging

**Note:** *Downloading and sending text messages using Bluetooth are cell phone-dependent features.*

**Note:** *Certain features in text messaging are speed-dependent and not available when your vehicle is traveling at speeds over 3 mph (5 km/h).*

### Receiving a Text Message

**When a new message arrives, an audible tone sounds and the screen displays a pop-up with the caller name and ID, if supported by your cell phone. You can select:**

Menu Item	Action and Description
Hear It	Have SYNC 3 read the message to you.
View	View the text on the touchscreen.
Call	To call the sender.
Reply	You can select from 15 preset messages. Press the message that you would like to use and confirm to send the message. SYNC 3 confirms when the message is sent successfully.
Close	To exit the screen.

### Smartphone Connectivity (If Equipped)

SYNC 3 allows you to use Apple CarPlay and Android Auto to access your phone.

When you use Apple CarPlay or Android Auto, you can:

- Make calls.
- Send and receive messages.
- Listen to music.
- Use your phone's voice assistant.

Apple CarPlay and Android Auto disable some SYNC 3 features.

Most Apple CarPlay and Android Auto features use mobile data.

#### Apple CarPlay

Apple CarPlay requires an iPhone 5 or newer with iOS 7.1 or newer. Updating to the latest iOS version is recommended.

1. Plug your phone into a USB port. See **USB Port** (page 459).

## SYNC™ 3 (If Equipped)

- Follow the prompts on the touchscreen.
- Follow the prompts that appear on your phone to allow access to Apple CarPlay.

After completing the setup, your phone connects to CarPlay automatically when plugged into a USB port.

### To disable this feature from the Settings screen, select:

Menu Item
Apple CarPlay Preferences
Your device is listed if SYNC detects Apple CarPlay. Select the name of your device and select:
Disable

To return to SYNC 3, go to the Apple CarPlay home screen and select the SYNC app.

**Note:** Contact Apple for Apple CarPlay support.

### Android Auto

Android Auto is compatible with most devices with Android 5.0 or newer.

- Download the Android Auto app to your device from Google Play to prepare your device (this may require mobile data usage).

**Note:** The Android Auto App may not be available within your current market.

- Plug your device into a USB port. See **USB Port** (page 459).
- To switch this feature on from the Settings screen, scroll left on the screen and select:

Menu Item
Android Auto Preferences
Enable Android Auto

**Note:** Android Auto must be switched on after plugging in your device.

### To disable this feature from the Settings screen, select:

Menu Item
Android Auto Preferences
Your device is listed if SYNC detects Android Auto. Select the name of your device and select:
Disable

**Note:** You may need to slide your Settings screen to the left to select **Apple CarPlay Preferences** or **Android Auto Preferences**.

To return to SYNC 3, select the speedometer icon in the Android Auto menu bar at the bottom of the touchscreen, and then touch the option to return to SYNC.

**Note:** Contact Google for Android Auto support.

## NAVIGATION

Your navigation system is comprised of two main features, destination mode and map mode.

## Map Mode

Map mode shows advanced viewing comprised of 2D city maps, 3D landmarks and 3D city models (when available). 2D city maps show detailed outlines of buildings, visible land use, landscape features, and detailed railroad infrastructure for the most essential cities around the globe.

3D landmarks appear as clear, visible objects that are typically recognizable and have a certain tourism value.

3D city models are complete 3D models of entire city areas including navigable roads, parks, rivers and rendered buildings. 3D landmarks and city models appear in 3D map mode only. Coverage of these varies and improves with updated map releases.



Select the zoom in icon to see a closer view of the map.



Select the zoom out icon to see a farther away view of the map.

You can adjust the view in preset increments. You can also pinch to zoom in or out of the map.

The information bar tells you the names of streets, cities or landmarks as you hover over them with the crosshair cursor.

You can change your view of the map by tapping on the location indicator icon on the right hand side of the screen. You can choose from the following options:



**Heading up (2D map)** This always shows the direction of forward travel to be upward on the screen. This view is available for map scales up to 3 mi (5 km).



**North up (2D map)** always shows the northern direction to be upward on the screen.



**3D map mode** provides an elevated perspective of the map. Adjust this viewing angle and rotate the map 180 degrees by touching the map twice, and then dragging your finger along the shaded bar with arrows at the bottom of the map.



Re-center the map by pressing this icon whenever you scroll the map away from your vehicle's current location.



**Mute:** Press to mute the audio navigation guidance. Press the button again to un-mute the guidance.



### Points of Interest (POI)

**grouping icon:** You can choose up to three POI icons to display on the map. If the chosen POIs are located close together or are

at the same location a box is used to display a single category icon instead of repeating the same icon, in order to reduce clutter. When you select the box on the map, a pop-up appears indicating how many POIs are in this location. Select the pop up to see a list of the available POIs. You can scroll through and select POIs from this list.

If your vehicle is low on charge or fuel, station icons automatically display on the map.

## SYNCTM 3 (If Equipped)

If you have subscribed to SiriusXM Traffic and Travel Link (where available), traffic flow will be indicated on the map by green (clear), yellow (slowing), and red (stopped) road highlights. Traffic flow is indicated where the information is available and varies across the US.

You can choose to display traffic icons on the map representing twelve different types of incidents. See **Settings** (page 546).

You can set a destination by hovering above a location and selecting:

Button
Start

### Destination Mode

**To set a destination, press:**

Menu Item	Description
Destination	
Enter a navigation destination in any of the following formats:	
Search	Street Address (number, street, city, state) For example "12 Mainstreet Dearborn MI"
	Partial Address (number, street) if searching in current state (number, street and zip code (or postal code in Canada)) if searching out of state You can enter unique addresses that contain door number prefixes with or without the prefix. For example, you could enter "6N340 Fairway Lane" or "340 Fairway Lane".
	City (name or zip code)
	Point of Interest (name or category)
	Intersection (street 1 / street 2) (street 1 and street 2) (street 1 & street 2) (street 1 @ street 2) (street 1 at street 2)

## SYNC™ 3 (If Equipped)

Menu Item	Description		
	<p>Latitude and Longitude (##.##### , ##.#####) This is in a decimal degrees format, one to six decimal places are accepted.</p> <p>You are given autocomplete options below the address bar to select as you type. If you do not give an exact destination, a menu displays with your possible selections.</p>		
Previous Destina- tions	Collections of your last 40 navigation destinations display here. You can select any option from the list to select it as your destination.		
	<table border="1" style="width: 100%;"> <tr> <td style="width: 20%;">Delete All</td> <td>Select this option to remove all previous destinations.</td> </tr> </table>	Delete All	Select this option to remove all previous destinations.
Delete All	Select this option to remove all previous destinations.		
Home	Select to navigate to your set Home destination. The time it takes to travel from your current location to Home displays. To set your Home, press:		
	<table border="1" style="width: 100%;"> <tr> <td style="width: 20%;">Home</td> <td>A prompt appears asking if you would like to create a favorite for home. Select:</td> </tr> </table>	Home	A prompt appears asking if you would like to create a favorite for home. Select:
	Home	A prompt appears asking if you would like to create a favorite for home. Select:	
	<table border="1" style="width: 100%;"> <tr> <td style="width: 20%;">Yes</td> <td>Enter a location into the search bar and press:</td> </tr> </table>	Yes	Enter a location into the search bar and press:
Yes	Enter a location into the search bar and press:		
Save			
Work	Select to navigate to your set Work destination. The time it takes to travel from your current location to Work displays. To set your Work:		
	<table border="1" style="width: 100%;"> <tr> <td style="width: 20%;">Work</td> <td>A prompt appears asking if you would like to create a favorite for work. Select:</td> </tr> </table>	Work	A prompt appears asking if you would like to create a favorite for work. Select:
	Work	A prompt appears asking if you would like to create a favorite for work. Select:	
	<table border="1" style="width: 100%;"> <tr> <td style="width: 20%;">Yes</td> <td>Enter a location into the search bar and press:</td> </tr> </table>	Yes	Enter a location into the search bar and press:
Yes	Enter a location into the search bar and press:		
Save			
Favorites	Favorites include any location you have previously saved. To add Favorites:		
	<table border="1" style="width: 100%;"> <tr> <td style="width: 20%;">Add a Favorite</td> <td>Select this button and enter a location into the destination bar.</td> </tr> </table>	Add a Favorite	Select this button and enter a location into the destination bar.
	Add a Favorite	Select this button and enter a location into the destination bar.	
	<table border="1" style="width: 100%;"> <tr> <td style="width: 20%;">Search</td> <td>Select this option to have the system locate the address you have entered.</td> </tr> </table>	Search	Select this option to have the system locate the address you have entered.
Search	Select this option to have the system locate the address you have entered.		
<table border="1" style="width: 100%;"> <tr> <td style="width: 20%;">Save</td> <td>Select this button when the address you have entered appears on the screen.</td> </tr> </table>	Save	Select this button when the address you have entered appears on the screen.	
Save	Select this button when the address you have entered appears on the screen.		

## SYNCTM 3 (If Equipped)

Menu Item	Description	
	The address saves as a favorite and you see the favorites screen. You can now select this address from the favorites screen.	
Point of Interest (POI) Categories	POI categories that may display (based on market and vehicle configuration):	
	Food	
	Fuel	
	Hotel	
	ATM	
	See All	Press to view additional categories. Once you have selected a category, follow the menus to find what you are looking for.
	Inside of these categories you can search by:	
	Nearby	
	Along Route	
	Near Destination	
In a City		

### Once you have chosen your destination, press:

Menu Item	Action and Description	
Save	This saves the destination to your favorites.	
Start	This shows you a map of your entire route. You can then choose your route from three different options.	
	Fastest	Uses the fastest moving roads possible.
	Shortest	Uses the shortest distance possible.
	Economical Route	Uses the most fuel-efficient route.
	The time and distance for each route also displays.	
Cancel	On the route screen, you can choose to cancel the current navigation. The system asks for confirmation then returns you to the map mode screen.	

# SYNC™ 3 (If Equipped)

## Once you have chosen your destination, press:

Menu Item	Action and Description
Start	<p>The system uses a variety of screens and prompts to guide you to your destination.</p> <p>During Route guidance, you can press the maneuver arrow icon on the map if you want the system to repeat route guidance instructions. When the system repeats the last guidance instruction, it updates the distance to the next guidance instruction, since it detects that the vehicle is moving.</p> <p>The navigation map shows your estimated time of arrival, remaining travel time and the distance to your destination.</p> <p>SYNC 3 may not always announce vehicle arrival at the exact point of your destination and you may have to cancel a route manually.</p>

## Navigation Menu

In map mode and during active navigation you can access the navigation menu.

During active navigation, touch the bottom of the screen to view the menu and other buttons.

## To access the Navigation menu, press:

Button		
Menu		
<b>You can then select:</b>		
Screen View	Full Map	A full screen map displays during navigation.
	Highway Exit Info	<p>Highway exit information displays on the right hand side of the screen during navigation.</p> <p>Points of interest icons display for restaurants, hotels, fuel stations and ATMs when they are present at the exit. You can select the POI icons to receive a listing of specific locations. You can select the POI location as a waypoint or destination if desired.</p>
	Turn List	<p>Only available during an active route. Displays all of the turns on the current route.</p> <p>You can choose to avoid any road on the turn list by selecting the road from the list. A screen then appears and you can press:</p>
		<p>Avoid</p> <p>The system calculates a new route and displays a new turn list.</p>

## SYNCTM 3 (If Equipped)

<b>Button</b>				
Traffic List	You can find the SiriusXM Traffic and Travel Link information by pressing this button. This information requires an active subscription to SiriusXM Traffic and Travel Link. When a route is not active, a list of nearby traffic incidents displays (if any are present). When a route is active, you can choose to display a list of traffic nearby or on the route.			
Navigation Settings	Press this button to adjust your preferences. See <b>Settings</b> (page 546).			
Where Am I?	Provides your current location city and the nearest road.			
The following are only available on the menu during an active navigation route:				
Cancel Route	The system asks for confirmation and then returns you to the map mode screen.			
View Route	Press this to see a map of the full route.			
Detour	An alternate route displays in comparison with the current route.			
Edit Waypoints	Only available if you have an active waypoint on your route. See <b>Waypoints</b> later in this section for information on how to set waypoints.			
	Use this button to re-order or remove your waypoints.			
	<table border="1"> <tr> <td>You can also have the system set the order for you by pressing:</td> <td>Optimize Order</td> </tr> <tr> <td>To return to your route press:</td> <td>Go</td> </tr> </table>	You can also have the system set the order for you by pressing:	Optimize Order	To return to your route press:
You can also have the system set the order for you by pressing:	Optimize Order			
To return to your route press:	Go			

### Waypoints

You can add a waypoint to a navigation route as a destination along your route.

To add a waypoint:

1. Select the search icon (magnifying glass) while on an active route. This brings up the destination menu.
2. Set your destination using any of the given methods. Once the destination has been selected, the screen allows you to set the destination as a waypoint by selecting:



# SYNC™ 3 (If Equipped)

Menu Item	
Add Waypoint	The waypoint list then appears and you are able to re-order all of your waypoints by selecting the menu icon on the right hand side of the location. You can select up to five waypoints.
You can also have the system set the order for you by pressing:	Optimize Order
To return to your route, press:	Go

## SYNC AppLink

The AppLink app allows you to use some SYNC 3 navigation features on your phone.

### First Mile Navigation

When you switch your ignition off, the location of your vehicle is recorded and sent to your SYNC AppLink app. The location of your vehicle can be viewed within the app. You can also view walking directions to your vehicle.

### Last Mile Navigation

When you park near your destination, the system provides walking directions to your destination.

### POI Search

Your paired phone can be used to access additional points of interest (POI). These points of interest can only be accessed when your phone is paired.

### Send To Car

You can send destinations to your navigation system using a computer or phone using AppLink.

## cityseeker (If Equipped)

**Note:** *cityseeker point of interest (POI) information is limited to approximately 1,110 cities (1,049 in the United States, 36 in Canada and 15 in Mexico).*



E225487

cityseeker, when available, is a service that provides more information about certain points of interest such as restaurants, hotels and attractions.

When you have selected a point of interest, the location and information appear, such as address, phone number and a star rating.

Press **More Information** to see a photo, a review, a list of services and facilities, the average room or meal price and the web address. This screen displays the point of interest icons.

## SYNC™ 3 (If Equipped)

For restaurants, cityseeker can provide information such as star rating, average cost, review, handicap access, hours of operation, and website address.

For hotels, cityseeker can provide information such as star rating, price category, review, check-in and checkout times, hotel service icons and website address. Hotel service icons include:

- Restaurant
- Business center
- Handicap facilities
- Laundry
- Refrigerator
- 24 hour room service
- Fitness center
- Internet access
- Pool
- Wi-Fi

Attractions include nearby landmarks, amusement parks, historic buildings and more. cityseeker can provide information such as star rating, reviews, hour of operation and admission price.

### **SiriusXM Traffic and Travel Link (If Equipped)**

SiriusXM Traffic and Travel Link is available on vehicles equipped with navigation and only in select markets. You must activate and subscribe to receive SiriusXM Traffic and Travel Link information. It helps you locate the best gas prices, find movie listings, get current traffic alerts, view the weather map, get accurate ski conditions and see current sports scores. See **Apps** (page 543).

The system calculates a reasonable efficient route based on available speed limits, traffic, and road conditions. You may know a local short cut that is more efficient at a given time than the route provided by SYNC 3, but you should expect a slight difference in minutes or miles with the SYNC 3 route.

### **Navigation Map Updates**

Annual navigation map updates are available for purchase through your dealership, by calling 1-866-462-8837 in the United States and Canada or 01-800-557-5539 in Mexico. You can also visit:

Website
<a href="http://www.navigation.com/sync">www.navigation.com/sync</a>

You need to specify the make and model of your vehicle to determine if there is an update available.

HERE is the digital map provider for the navigation application. If you find map data errors, you may report them directly to HERE by going to [www.here.com/mapcreator](http://www.here.com/mapcreator). HERE evaluates all reported map errors and responds with the result of their investigation by e-mail.

Map coverage includes the USA (including Puerto Rico and the US Virgin Islands), Canada and Mexico.

### **APPS**

The system enables voice, steering wheel, and touch screen control of SYNC 3 AppLink enabled smartphone apps.

Once an app is running through AppLink, you can control main features of the app through voice commands and steering wheel controls.

# SYNC™ 3 (If Equipped)

**Note:** Available AppLink enabled apps will vary by market.

**Note:** You must pair and connect your smartphone via Bluetooth to SYNC 3 to access AppLink.

**Note:** iPhone users need to connect the phone to the USB port.

**Note:** For information on available apps, supported smartphone devices and troubleshooting tips please visit:

Websites
owner.ford.com www.syncmyride.ca www.syncmaroute.ca

**Note:** Make sure you have an active account for the app that you have downloaded. Some apps will work automatically with no setup. Other apps will want you to configure your personal settings and personalize your experience by creating stations or favorites. We recommend you do this at home or outside of your vehicle.

**Note:** We encourage you to review the smartphone app's terms of service and privacy policies because Ford is not responsible for your app or its use of data.

**Note:** AppLink is a native SYNC system feature. Accessing mobile apps through AppLink is only possible when Android Auto or Apple CarPlay are disabled. Some apps may only be accessible in the car through AppLink and others only through Android Auto or Apple CarPlay. Please refer to the Smartphone Connectivity information to disable Android Auto or Apple CarPlay.

**Note:** In order to use an app with SYNC 3, the app needs to be running in the background of your phone. If you shut down the app on your phone, it shuts down the app on SYNC 3 as well.

**Note:** If a SYNC 3 AppLink compatible app is not shown in the Apps Domain, make sure the required app is running on the mobile device.

Menu Item	Action and Description
Find Mobile Apps	SYNC 3 will search and connect to compatible app(s) running on your mobile device.

## Enabling SYNC 3 Mobile Apps

In order to enable mobile apps, SYNC 3 requires user consent to send and receive app authorization information and updates using the data plan associated with the connected device.

The connected device sends data to Ford in the United States. The information is encrypted and includes your VIN, SYNC 3 module number, odometer, usage statistics and debugging information. We retain this data for only as long as necessary to provide this service, troubleshoot, and improve products and services and to offer you products and services that may interest you where allowed by law.

**Note:** You must enable mobile apps for each connected device the first time you select a mobile app using the system.

**Note:** Ford reserves the right to limit functionality or deactivate mobile apps at any time.

**Note:** Standard data rates apply. Ford is not responsible for any additional charges you may receive from your service provider, when your vehicle sends or receives data through the connected device. This includes any additional charges incurred due to driving in areas when roaming out of a home network.

You can enable and disable apps through settings. See **Settings** (page 546).

## App Permissions

The system organizes the app permissions into groups. You can grant these group permissions individually. You can change a permission group status any time when not driving, by using the settings menu. While in the settings menu, you can also see the data included in each group.

When you launch an app using SYNC 3, the system may ask you to grant certain permissions, for example Vehicle information, Driving characteristics, GPS and Speed, and/or Push notifications. You can enable all groups or none of them during the initial app permissions prompts. The settings menu offers individual group permission control.

**Note:** You are only prompted to grant permissions the first time you use an app with SYNC 3.

**Note:** If you disable group permissions, apps will still be enabled to work with SYNC 3 unless you deactivate All Apps in the settings menu.

## SiriusXM Traffic and Travel Link (If Equipped)

### WARNING



Driving while distracted can result in loss of vehicle control, crash and injury. We strongly recommend that you use extreme caution when using any device that may take your focus off the road. Your primary responsibility is the safe operation of your vehicle. We recommend against the use of any hand-held device while driving and encourage the use of voice-operated systems when possible. Make sure you are aware of all applicable local laws that may affect the use of electronic devices while driving.

**Note:** SiriusXM Traffic and Travel Link may not be available in all markets.

**Note:** In order to use SiriusXM Traffic and Travel Link, your vehicle must have navigation.

**Note:** A paid subscription is required to access and use these features. Go to [www.siriusxm.com/travellink](http://www.siriusxm.com/travellink) for more information.

**Note:** Visit [www.siriusxm.com/traffic](http://www.siriusxm.com/traffic) and click on Coverage map and details for a complete listing of all traffic areas covered by SiriusXM Traffic and Travel Link.

**Note:** Neither Sirius nor Ford is responsible for any errors or inaccuracies in the SiriusXM Traffic and Travel Link services or its use in vehicles.

When you subscribe to SiriusXM Traffic and Travel Link, it can help you locate the best gas prices, find movie listings, get current traffic alerts, view the current weather map, get accurate ski conditions and see scores to current sports games.

# SYNC™ 3 (If Equipped)

Menu Item	Action and Description	
Traffic on Route	Touch these buttons to identify traffic incidents on your route, near your vehicle's current location or near any of your favorite places, if programmed.	
Traffic Nearby		
Fuel Prices	Touch this button to view fuel prices at stations close to your vehicle's location or on an active navigation route.	
Movie Listings	Touch this button to view nearby movie theaters and their show times, if available.	
Weather	Touch this button to view the nearby weather, current weather, or the five-day forecast for the chosen area.	
	Map	Select to see the weather map, which can show storms, radar information, charts and winds.
	Area	Select to choose from a listing of weather locations.
Sports Info	Touch this button to view scores and schedules from a variety of sports. You can also save up to 10 favorite teams for easier access. The score automatically refreshes when a game is in progress.	
Ski Conditions	Touch this button to view ski conditions for a specific area.	

## Sound

Pressing this button allows you to adjust the following:

## SETTINGS

Under this menu, you can access and adjust the settings for many of the system features. To access additional settings, swipe the screen left or right.

Sound Settings	
Reset All	Returns Treble, Midrange, and Bass sound settings to factory levels.
Treble	Adjusts the high frequency level.
Midrange	Adjusts the middle frequency level.
Bass	Adjusts the low frequency level.
Balance / Fade	Adjusts the sound ratio from side to side or front to back.

## SYNC™ 3 (If Equipped)

Sound Settings	
Speed Compensated Vol.	Adjusts the amount the audio system volume increases with speed, or turns the feature off.
Occupancy Mode	Optimizes the sound based on the location of the listeners.
Sound Settings	Stereo
	Surround

Your vehicle might not have all of these features.

### Media Player

This button is available when a media device such as a Bluetooth Stereo or USB device is the active audio source. Pressing the button allows you to access the following options for active devices only.

Menu Item	Action and Description		
Podcast Speed	For some USB devices, SYNC 3 can adjust the playback speed of podcasts. When a podcast is playing, you can choose:		
	Slower	Normal	Faster
Audiobook Speed	For some USB devices, SYNC 3 can adjust the playback speed of audiobooks. When an audiobook is playing, you can choose:		
	Slower	Normal	Faster
Cover Art Priority	Media Player	Cover art displays from your device's music files. If no cover art for the files exists on the device, then the Gracenote Database provides cover art.	
	Gracenote®	The Gracenote Database supplied cover art is used for your music files. This overrides any cover art from your device.	
Gracenote® Management	Switches on and off Gracenote® to provide metadata information such as genre, artist, album.		

## SYNC™ 3 (If Equipped)

Menu Item	Action and Description
Gracenote® Database Info	This allows you to view the version level of the Gracenote Database.
Device Information	This allows you to view the manufacturer and model number of your media device.
Update Media Index	Erase the stored in media information in order to re-index.

You can adjust the following features:

### Clock

To adjust the time, select the up and down arrows on either side of the screen. The arrows on the left adjust the hour and arrows on the right adjust the minute. You can then select AM or PM.

Menu Item	Action and Description
Clock Format	Select how time displays.
Auto Time Zone Update	When active, the clock adjusts to time zone changes. This feature is only available in vehicles with navigation.
Reset Clock to GPS Time	When selected, the vehicle clock resets to GPS satellite time.

The system automatically saves any updates you make to the settings.

### Bluetooth

Pressing this button allows you to access the following:

Menu Item	Action
Bluetooth	Turning Bluetooth off disconnects all devices and does not permit new connections.

You must activate Bluetooth to pair a Bluetooth-enabled device.

The processes of pairing a Bluetooth device is the same as pairing a phone. **See Pairing a Device** in Phone settings for how to pair a device and the available options.

### Phone

Pair your Bluetooth-enabled phone with the system before using the functions in hands-free mode.

Switch on Bluetooth on your device to begin pairing. See your phone's manual if necessary.

## SYNC™ 3 (If Equipped)

### To add a phone, select:

Menu Item
Add Phone

1. Follow the on-screen instructions.
2. A prompt alerts you to search for the system on your phone.
3. Select your vehicle's make and model as it displays on your phone.
4. Confirm that the six-digit number appearing on your phone matches the six-digit number on the touchscreen.
5. The touchscreen indicates when the pairing is successful.
6. Your phone may prompt you to give the system permission to access information. To check your phone's compatibility, see your phone's manual or visit the website.

### Alternatively, to add a phone, select:

Menu Item
Add Phone
<b>Then select:</b>
Discover Other Bluetooth Devices

1. Follow the on-screen instructions.
2. Select your phone's name when it appears on the touchscreen.
3. Confirm that the six-digit number appearing on your phone matches the six-digit number on the touchscreen.
4. The touchscreen indicates when the pairing is successful.
5. Your phone may prompt you to give the system permission to access information. To check your phone's compatibility, see your phone's manual or visit the website.

Other features, such as text messaging using Bluetooth and automatic phonebook download, are phone-dependent features.

### To check your phone's compatibility, see your phone's manual or visit the website:

Website
owner.ford.com www.syncmyride.ca www.syncmaroute.ca

Once you have paired a device you can adjust the following options.

Menu Item	Action and Description
View Devices	
<b>You can then select:</b>	
Add a Bluetooth Device	You can add a Bluetooth-enabled device by following the steps in the previous table.
You can select a phone by touching the name of the phone on the screen. You then have the following options:	
Connect	Depending on the status of the device, you can select either of these options to interact with the selected device.



## SYNC™ 3 (If Equipped)

Menu Item	Action and Description
Disconnect	
Make Primary	Allows you to select this device to be your preferred device.
Delete	Removes the selected device from the system.

Pressing the info icon next to the device name allows you to see phone and device information

Menu Item	Action and Description	
Manage Contacts		
<b>You can then select:</b>		
Auto-Download Contacts	Enable this option to have SYNC 3 periodically re-download your phonebook to keep your contact list up to date.	
Sort By:	Choose how you would like the system to display your contacts. You can choose:	
	<table border="1" style="width: 100%;"> <tr> <td style="width: 50%; text-align: center;">First Name</td> <td style="width: 50%; text-align: center;">Last Name</td> </tr> </table>	First Name
First Name	Last Name	
Re-download Contacts	Select this option to re-download your contact list manually.	
Delete Contacts	Select this option to delete the in vehicle contact list. Deleting the in vehicle list does not erase the contact list on the connected phone.	

Menu Item	Action and Description
Set Phone Ringtone	
<b>You can then select:</b>	
No Ringtone	No sound plays when a call comes to your phone.
Use Phone Ringtone	The currently selected ringtone on your phone plays when you receive a call. This option may not be available for all phones. If this option is available, it is the default setting.
You can also select one of the three available ringers.	

## SYNCTM 3 (If Equipped)

Menu Item	Action and Description
Text Messaging	
<b>You can then select:</b>	
No Alert (Silence)	No sound plays when a message comes to your phone.
You can select one of the three available notification sounds.	
Voice Readout	When enabled, a voice prompt alerts you when you receive a new message.

### You can enable and disable the following options as well:

Menu Item	Action and Description
Mute Audio in Privacy	When enabled, vehicle audio (such as radio or apps) is muted for the duration of the phone call even when the phone call is in privacy.
Roaming Warning	When enabled, an alert displays that your phone is roaming when you attempt to place a call.
Low Battery Notification	When enabled, a message displays when the battery on your phone is running low.

### 911 Assist

**Note:** *This service is only available in the United States and Canada.*

Select this button to modify the on or off setting for this feature. If the mobile phone's contacts have been downloaded, you can adjust the following option:

Menu Item	Action and Description
Set Emergency Contacts	You can select up to two numbers from your mobile device's phone-book as emergency contacts for quick access at the end of the 911 Assist call process.

### Radio

This button is available if a Radio source such as AM or FM is the active media source. Pressing the button allows you to access the following features:

## SYNC™ 3 (If Equipped)

Menu Item	Action and Description
FM HD Radio AM HD Radio (Dependent on current radio source, If Available)	Activation of this feature allows you to listen to HD radio broadcasts.
Radio Text	This feature is available when FM Radio is your active media source. Activate this feature to have the system display radio text.
Autoset Presets (AST)	Refresh Selecting this option stores the six strongest stations in your current location to the last preset bank of the currently tuned source.

### Sirius XM (If equipped)

Menu Item	Action and Description
Set Category for Seek	After selecting a category, seek function only stops on channels which are inside that selected category.
Parental Lockout	Select to create a personal identification number (PIN). This allows you to lock or unlock channels. Your initial PIN is 1234.
Edit Alerts	Select to switch on, off or delete alerts.

The Electronic Serial Number can also be found on this screen. This number is necessary to activate, modify or track your account through Sirius XM.

### Navigation

You can adjust many of the Navigation preferences by selecting the following menus.

# SYNCTM 3 (If Equipped)

## Map Preferences

Menu Item	Action and Description	
Map Preferences		
<b>Then select any of the following:</b>		
3D City Model	When this option is active, the system shows 3D renderings of buildings.	
Breadcrumbs	When enabled, your vehicle's previously traveled route displays with white dots.	
POI Icons	Enable this feature to display up to 3 POI icons on the navigation map. A rest area POI icon may display on the map regardless of this setting.	
	Once this feature is activated you can select the icons you want displayed by selecting:	Select POIs
Incident Map Icons	This menu allows you to choose which incident icons you would like to have displayed on the navigation map.	

## Route Preferences

Menu Item	Second Level Messages, Actions and Descriptions		
Route Preferences			
<b>Then select any of the following:</b>			
Preferred Route	Choose to have the system display your chosen route type.		
	Shortest	Fastest	Eco
Always Use ____ Route	Bypass route selection in destination programming. The system only calculates one route based on your preferred route setting. When activated, the system uses your selected route type to calculate only one route to the desired destination.		
Use HOV Lanes	The system selects High Occupancy Vehicle or car pool lanes when providing route guidance.		
Automatically Find Parking	The system searches for and displays available parking locations as you approach your destination.		
Eco Time Penalty	Select a level of cost for the calculated Eco Route. The higher the setting, the longer the time allotment is for the route.		

# SYNC™ 3 (If Equipped)

Menu Item	Second Level Messages, Actions and Descriptions
Dynamic Route Guidance	Enable or disable considering traffic information when planning a route. The system can find a faster route based on heavy traffic flow information or detect a Road Closed incident and find a detour route if possible.
Avoid Freeways	If selected, SYNC 3 avoids freeways when computing a navigation route.
Avoid Toll Roads	If selected, SYNC 3 avoids Toll Roads when computing a navigation route.
Avoid Ferries/Car Trains	If selected, SYNC 3 avoids the use of Ferries or Trains when computing a navigation route.

## Navigation Preferences

Menu Item	Action and Description
Navigation Preferences	
Guidance Prompts	You can adjust how the system provides prompts.
<b>Then select any of the following:</b>	
Voice and Tones	A tone sounds followed by voice instructions.
Voice Only	Only voice instructions are given.
Tones Only	Only a tone sounds to prompt you.

## Mobile Apps

You can enable the control of compatible mobile apps running on your Bluetooth or USB device on SYNC 3. In order to enable mobile apps, SYNC 3 requires user consent to send and receive app authorization information and updates using the data plan associated with the connected device.

The connected device sends data to Ford in the United States. The encrypted information includes your VIN, SYNC 3 module number, anonymous usage statistics and debugging information. Updates may take place automatically.

**Note:** *All Mobile Apps may not be compatible with the system.*

## SYNC™ 3 (If Equipped)

**Note:** Standard data rates will apply. Ford is not responsible for any additional charges you may receive from your service provider, when your vehicle sends or receives data through the connected device. This includes any additional charges incurred due to driving in areas when roaming out of a home network.

Menu Item	Action and Description		
Mobile Apps	Enable or disable the use of mobile apps on SYNC 3. Disabling mobile apps in the settings menu disables automatic updates and the use of mobile apps on SYNC 3.		
	You can view the status of mobile app permissions in the settings menu.		
Once Mobile Apps is enabled, you have the following options:			
Update Mobile Apps	This provides information on the current state of available app updates.		
	There are three possible statuses:		
	Update Needed	Up-To-Date	Updating Mobile Apps...
	The system has detected a new app requiring authorization or a general permissions update is required.	No update is required.	The system is trying to receive an update.
	Request Update		Select this button if an update is required and you want to request this update manually. For example, when your mobile device is connected to a Wi-Fi hotspot, select:

## SYNC™ 3 (If Equipped)

Menu Item	Action and Description
	Request Update
All Apps	Grant or deny permissions to all apps at once.
There may also be SYNC 3 enabled apps listed under these options.	Grant or deny an individual app particular permissions. App permissions are organized into groups. By pressing the info book icon, you can see which signals are included in each group.

**Note:** Ford is not responsible or liable for any damages or loss of privacy relating to usage of an app, or dissemination of any vehicle data that you approve Ford to provide to an app.

### General

Access and adjust the system settings, voice features, as well as phone, navigation and wireless settings.

Menu Item	
Language	Select to have the touchscreen display in English, Spanish or French.
Distance	Select to display units in kilometers or miles.
Temperature	Select to display units in Celsius or Fahrenheit.
Touch Panel Beep	Select to have the system beep to confirm choices made through the touchscreen.
Automatic System Updates	When you activate this option, the system automatically updates when you have an available Internet connection through a Wi-Fi network or mobile connection.
About SYNC	Information pertaining to the system and its software.
Software Licenses	Documentation of the software license for the system.
Master Reset	Select to restore factory defaults. This erases all personal settings and personal data.

### Wi-Fi & Hotspot

Access SYNC Wi-Fi and Vehicle Hotspot settings and information.

### System Wi-Fi

You can access the following:

## SYNC™ 3 (If Equipped)

Menu Item	Action and Description
Wi-Fi	Enable this option to connect to Wi-Fi for SYNC 3 vehicle software updates.
Available Networks	This provides you with a list of available Wi-Fi networks within range.
	Clicking on a network from the list allows you to connect or disconnect from that network. The system may require a security code to connect.
	When you click the information button next to a network, more information about the network displays such as the signal strength, connection status and security type.
Wi-Fi Available Notifications	The system alerts you when your vehicle is parked and a Wi-Fi network is within range if SYNC is not already connected.

### Vehicle Hotspot (If Equipped)

You can access the following:

Menu Item	Action and Description
Wi-Fi Hotspot On/Off	Allows you to turn the hotspot on and off.
Settings	Allows you to view and edit hotspot settings such as the SSID and password.
Data Usage	Allows you to view your vehicle's hotspot plan and data usage.
Manage Devices	Allows you to manage devices connected to your hotspot.

**Note:** *The Vehicle Wi-Fi Hotspot (Vehicle Hotspot) may be operational while ignition is On and may remain operational while the ignition is Off.*

**Note:** *Vehicle Hotspot services are provided by the vehicle network carrier, subject to your vehicle network carrier agreement, coverage and availability.*

**Note:** *It is the account owner's responsibility to remove the vehicle from the vehicle network carrier account when ownership of the vehicle is transferred. If the owner would like to remove the vehicle from the account for any reason, please contact your vehicle network carrier for more information.*



## SYNC™ 3 (If Equipped)

**Note:** : Data, e.g. the Vehicle Identification Number (VIN), SIM Card ID, and data plan usage, is shared between Ford and the vehicle network carrier to provide the Vehicle Hotspot service in accordance with your vehicle network carrier agreement, coverage and availability, and may be used to enable a seamless transition from an old to new embedded modem and to confirm any updates are successfully delivered.

**Note:** : For your convenience data usage may be available for monitoring under Settings but may not reflect actual or current usage. The vehicle network carrier is responsible for providing information about your account. Please contact the vehicle network carrier for more information.

**Note:** : Ford may need to update operating system software on your vehicle, including security updates and bug fixes, to keep connected services current, like Vehicle Hotspot, without prior notice to you.

**Note:** If you do not have an active vehicle hotspot data plan, open your web browser and go to a website using the HTTP protocol to be automatically redirected to the vehicle network carrier landing page where you can purchase data. Websites using HTTPS will not automatically redirect.

### Camera Settings

**To make adjustments using the touchscreen, select:**

Message	Action and Description
Camera Settings	
<b>Then select from the following:</b>	
Enhanced Park Aids	When the reverse sensing system detects an object, it displays red, yellow and green highlights at the top of the image.
Rear Camera Delay	You can enable or disable this option using the slider.

You can find more information on the rear-view camera system in the parking aids chapter of your owner manual.

### Ambient Lighting (If Equipped)

Tap a color once to active ambient lighting. This sets the color to the highest intensity.

You can drag the colors up and down to increase or decrease the intensity.

To switch ambient lighting off, press the active color once or drag the active color all the way down to zero intensity.

### Vehicle

**Note:** Your vehicle may not have all of these features.

You can select the following features to update their settings.

### Door Keypad Code (If equipped)

Select this button to add or erase a personal door keypad code. To add or erase a personal code, you first need to enter the five-digit factory set code. You can find this code on the owner's wallet card in the glove box or from your authorized dealer.

# SYNCTM 3 (If Equipped)

## Onboard Modem Serial Number (ESN)

Selecting this button on the settings menu

shows you the ESN number for your system. You need this number for certain registrations such as Satellite Radio.

## Display

To make adjustments using the touchscreen, select:

Menu Item	Action and Description	
Brightness	Make the screen display brighter or dimmer.	
Mode	You can select:	
	Auto	The screen automatically switches between day and night modes based on the outside light level.
	Day	The screen displays with a light background to enhance daytime viewing.
	Night	The screen displays with a darker background to make nighttime viewing easier.
	Off	The screen goes black and does not display anything. To switch the screen back on, simply tap the screen.
Auto Dim	Enable this option to automatically dim the display brightness based on ambient lighting conditions.	

## Voice Control

You can adjust the voice control settings by selecting the following options.

Menu Item	
Advanced Mode	Enable this option to remove additional voice prompts and confirmations.
Phone Confirmation	Enable this option to have the system confirm a contacts name with you before making a call.
Voice Command List	Enable this option to have the system display a list of available voice commands when the voice button is pressed.

# SYNC™ 3 (If Equipped)

## Valet Mode

Valet mode allows you to lock the system. No information is accessible until the system is unlocked with the correct PIN.

When you select valet mode a pop up appears informing you that a four digit code must be entered to enable and disable valet mode. You can use any PIN you chose but you must use the same PIN to disable valet mode. The system asks you to input the code.

**Note:** *If the system is locked and you cannot remember the PIN, please contact the Customer Relationship Center.*

United States: 1-800-392-3673

Canada: 1-800-565-3673

To enable valet mode, enter your chosen PIN. The system then asks to confirm your PIN by reentering it. The system then locks.

To unlock the system, enter the same pin number. The system reconnects to your phone and all of your options are available again.

## SYNC™ 3 TROUBLESHOOTING

Your SYNC 3 system is easy to use. However, should questions arise, please refer to the tables below.

To check your cell phone's compatibility, refer to the regional Ford or Lincoln website.

Cell phone issues		
Issue	Possible cause	Possible solution
There is background noise during a phone call.	The audio control settings on your cell phone may be affecting SYNC 3 performance.	Refer to your device's manual about audio adjustments.
During a call, I can hear the other person but they cannot hear me.	Possible cell phone malfunction.	Try switching your cell phone off, resetting it or removing the battery, then try again.
		Make sure that the microphone for SYNC 3 is not set to off. Look for the microphone icon on the phone screen.
During a call, I cannot hear the other person and they cannot hear me.	The system may need to be restarted.	To restart your system, shut down the engine, open and close the door, and then lock the door and wait for 2-3 minutes. Make sure that your SYNC 3 screen is black and the lighted USB port is off.
SYNC 3 is not able to download my phone-book.	This is a cell phone-dependent feature.	Check your cell phone's compatibility.
	Possible cell phone malfunction.	Make sure you allow SYNC 3 to retrieve contacts from your phone. Refer to your cell manual.

## SYNC™ 3 (If Equipped)

<b>Cell phone issues</b>		
<b>Issue</b>	<b>Possible cause</b>	<b>Possible solution</b>
		You must switch on your cell phone and the automatic phonebook download feature on SYNC 3.
		Try switching your cell phone off, resetting it or removing the battery, then try again.
The system says "Phone-book down-loaded" but my SYNC 3 phone-book is empty or is missing contacts.	Limitations on your cell phone's capability.	Make sure you allow SYNC 3 to retrieve contacts from your phone. Refer to your cell manual.
		If the missing contacts are stored on your SIM card, move them to your cell phone's memory.
		You must switch on your cell phone and the automatic phonebook download feature on SYNC 3.
I am having trouble connecting my cell phone to SYNC 3.	This is a cell phone-dependent feature.	Check your cell phone's compatibility.
	Possible cell phone malfunction.	Try switching your cell phone off, resetting it or removing the battery, then try again.
		Try deleting your device from SYNC 3 and deleting SYNC from your device, then trying again.
		Always check the security and auto accept prompt settings relative to the SYNC 3 Bluetooth connection on your cell phone.
		Update your cell phone's firmware.
		Switch the auto download setting off.
Text messaging is not working on SYNC 3.	This is a cell phone-dependent feature.	Check your cell phone's compatibility.
	Possible cell phone malfunction.	Try switching your cell phone off, resetting it or removing the battery, then try again.
	iPhone	<ul style="list-style-type: none"> <li>• Go to your cell phone's Settings.</li> <li>• Go to the Bluetooth Menu.</li> </ul>

## SYNC™ 3 (If Equipped)

<b>Cell phone issues</b>		
<b>Issue</b>	<b>Possible cause</b>	<b>Possible solution</b>
		<ul style="list-style-type: none"> <li>• Press the blue circle to the right of the device named with your vehicle make and model to enter the next menu.</li> <li>• Turn Show Notifications on.</li> <li>• Disconnect then reconnect your iPhone from the SYNC 3 system to activate this settings update.</li> </ul> <p>Your iPhone is now set up to forward incoming text messages to SYNC 3. Repeat these steps for every other SYNC 3 vehicle that you connect. Your iPhone will only forward incoming text messages to SYNC 3 if the iPhone is not unlocked in the messaging application. Replying to text messages using SYNC 3 is not supported by iPhone. Text messages from WhatsApp and Facebook Messenger are not supported.</p>
Audible text messages do not work on my cell phone.	This is a cell phone-dependent feature.	Your cell phone must support downloading text messages through Bluetooth to receive incoming text messages.
	This is a cell phone limitation.	Because each cell phone is different, refer to your device's manual for the specific cell phone you are pairing. In fact, there can be differences between cell phones due to brand, model, service provider and software version.

## SYNC™ 3 (If Equipped)

<b>USB and Bluetooth Stereo issues</b>		
<b>Issue</b>	<b>Possible cause</b>	<b>Possible solution</b>
I am having trouble connecting my device.	Possible device malfunction.	Disconnect the device from SYNC 3. Try switching your device off, resetting it or removing the battery, then reconnect it to SYNC 3.
		Make sure you are using the manufacturer's cable.
		Make sure to correctly insert the USB cable into the device and your vehicle's USB port.
	Make sure that the device does not have an auto-install program or active security settings.	
	The device has a lock screen enabled.	Make sure your device is unlocked before connecting it to SYNC 3.
SYNC 3 does not recognize my device when I start my vehicle.	This is a device limitation.	Make sure you are not leaving the device in your vehicle during very hot or cold temperatures.
Bluetooth audio does not stream.	This is a device-dependent feature.	Make sure you connect the device to SYNC 3 and that you have started the media player on your device.
	The device is not connected.	
	The device is in a bad state.	Try switching your device off, resetting it or removing the battery, then reconnect it to SYNC 3.
SYNC 3 does not recognize music that is on my device.	Your music files may not contain the correct artist, song title, album or genre information.	Make sure that all song details are populated.
	The file may be corrupted.	Try replacing the corrupt file with a new version.
	The song may have copyright protection that does not allow it to play.	Some devices require you to change the USB settings from mass storage to media transfer protocol class.

## SYNC™ 3 (If Equipped)

<b>USB and Bluetooth Stereo issues</b>		
<b>Issue</b>	<b>Possible cause</b>	<b>Possible solution</b>
	The file format is not supported by SYNC 3.	Convert the file to a supported format. See <b>Entertainment</b> (page 517).
	The device needs to be re-indexed.	Update media index. See <b>Settings</b> (page 546).
	The device has a lock screen enabled.	Make sure your device is unlocked before connecting it to SYNC 3.
When I connect my device, I sometimes do not hear any sound.	This is a device limitation.	Disconnect the device from SYNC 3. Try switching your device off, resetting it or removing the battery, then connect it back to SYNC 3.
		To listen to Apple devices through USB, select AirPlay from the devices Control Center, then select Dock Connector.
		To listen to Apple devices through Bluetooth Stereo, select AirPlay from the devices Control Center, then select SYNC.
SYNC 3 does not display the song information, repeat, or shuffle buttons.	The device or media player is incompatible.	Connect a compatible device or media player.

<b>Wi-Fi Issues</b>		
<b>Issue</b>	<b>Possible cause</b>	<b>Possible solution</b>
Failed connection.	Password error.	Verify password.
	Weak signal.	Check for a poor Wi-Fi signal.
	Multiple Access points within range with the same SSID.	Use a unique name for your SSID, don't use the default name unless it contains a unique identifier, such as part of the MAC address.

## SYNC™ 3 (If Equipped)

<b>Wi-Fi Issues</b>		
<b>Issue</b>	<b>Possible cause</b>	<b>Possible solution</b>
Disconnecting after successful connection.	Weak signal probably due to distance from the hotspot, obstruction or high interference.	Position the vehicle close to the hotspot with the front of the vehicle facing the hotspot direction and remove obstacles if possible. Other Wi-Fi, Bluetooth, microwave and cordless phones may cause interference.
Poor signal seen by SYNC 3 despite being near a hotspot.	There may be an obstruction between SYNC 3 and the hotspot.	If the vehicle is equipped with heated windshield, try positioning the vehicle so that the windshield is not facing the hotspot. If you have metallic window tinting but not on the windshield, position the vehicle to face the hotspot. If all windows are tinted, you can open the windows in the direction of the hotspot if that is feasible. Try to remove other obstructions that may impact signal quality such as opening the garage door.
A hotspot is not listed in the list of available networks.	The hotspot was defined as a hidden network.	Please set the network to visible and try again.



## SYNC™ 3 (If Equipped)

<b>Wi-Fi Issues</b>		
<b>Issue</b>	<b>Possible cause</b>	<b>Possible solution</b>
SYNC 3 is not seen when searching for Wi-Fi networks from your phone or other devices.	SYNC 3 does not currently provide a hotspot.	SYNC 3 currently does not provide a hotspot.
Software download takes too long.	Poor signal strength, too far from the hotspot, hotspot is supporting multiple connections, slow Internet connection or other problems.	Check the signal quality (under network details), if SYNC 3 indicates good or excellent, test with another high-speed equipped hotspot where the environment is more predictable.
SYNC 3 seems to connect with a hotspot and the signal strength is excellent but the software is not being updated.	It is possible that there is no new software. The connected hotspot may be a managed one and it requires either a subscription or agreeing to the terms and conditions.	Test the connection with another device, if the hotspot requires a subscription, you may contact the service provider.

## SYNC™ 3 (If Equipped)

<b>AppLink issues</b>		
<b>Issue</b>	<b>Possible cause(s)</b>	<b>Possible solution(s)</b>
AppLink Mobile Applications: When I select "Find Mobile Apps," SYNC 3 does not find any applications.	You did not connect an AppLink Compatible phone to SYNC 3.	Make sure you have a compatible smartphone; an Android with OS 2.3 or higher or an iPhone 3GS or newer with iOS 5.0 or higher. Additionally, make sure you pair and connect your phone to SYNC 3 in order to find AppLink-capable apps on your device. iPhone users must also connect to a USB port with an Apple USB cable.
My phone is connected, but I still cannot find any apps.	AppLink-enabled apps are not installed and running on your mobile device.	Make sure you have downloaded and installed the latest version of the app from your phone's app store. Make sure the app is running on your phone. Some apps require you to register or login to the app on the phone before using them with AppLink. Also, some may have a "Ford SYNC" setting, so check the app's settings menu on the phone.
My phone is connected, my app(s) are running, but I still cannot find any apps.	Sometimes apps do not properly close and re-open their connection to SYNC 3, over ignition cycles, for example.	<p>Closing and restarting apps may help SYNC 3 find the application if you cannot discover it inside the vehicle. On an Android device, if apps have an 'Exit' or 'Quit' option, then select it and restart the app. If the app does not have that option, select the phone's settings menu and select 'Apps', then find the particular app and choose 'Force stop.' Do not forget to restart the app afterward, then select "Find Mobile Apps" on SYNC 3.</p> <p>On an iPhone with iOS7+, to force close an app, double tap the home button then swipe up on the app to close it. Tap the home button again, then select the app again to restart it. After a few seconds, the app should then appear in SYNC 3's Mobile App's Menu.</p>

## SYNC™ 3 (If Equipped)

<b>AppLink issues</b>		
<b>Issue</b>	<b>Possible cause(s)</b>	<b>Possible solution(s)</b>
My Android phone is connected, my app(s) are running, I restarted them, but I still cannot find any apps.	There is a Bluetooth issue on some older versions of the Android operating system that may cause apps that were found on your previous vehicle drive to not be found again if you did not switch Bluetooth off.	Switch Bluetooth off and then on to reset it on your phone. If you are in your vehicle, SYNC 3 should be able to automatically re-connect to your phone if you press the "Phone" button.
My iPhone is connected, my app is running, I restarted the app but I still cannot find it on SYNC 3.	You may need to reset the USB connection to SYNC 3.	Unplug the USB cable from the phone, wait a moment, and plug the USB cable back in to the phone. After a few seconds, the app should appear in SYNC 3's Mobile Apps Menu. If not, "Force Close" the application and restart it.
I have an Android phone. I found and started my media app on SYNC 3, but there is no sound or the sound is very low.	The Bluetooth volume on the phone may be low.	Increase the Bluetooth volume of the device by using the device's volume control buttons which are most often found on the side of the device.
I can only see some of the AppLink apps running on my phone listed in the SYNC 3 Mobile Apps Menu.	Some Android devices have a limited number of Bluetooth ports that apps can use to connect. If you have more AppLink apps on your phone than the number of available Bluetooth ports, you will not see all of your apps listed in the SYNC 3 mobile apps menu.	Force close or uninstall the apps you do not want SYNC 3 to find. If the app has a "Ford SYNC" setting, disable that setting in the app's settings menu on the phone.

## SYNC™ 3 (If Equipped)

<b>Voice command issues</b>		
<b>Issue</b>	<b>Possible cause</b>	<b>Possible solution</b>
SYNC 3 does not understand what I am saying.	You may be using the wrong voice commands.	Review the cell phone voice commands and the media voice commands at the beginning of their respective sections.
		Refer to the audio display during an active voice session to find a list of voice commands there.
	You may be speaking too soon or at the wrong time.	Wait for the system to prompt you before you state your command.
SYNC 3 does not understand the name of a song or artist.	You may be using the wrong voice commands.	Review the media voice commands at the beginning of the media section.
	You may not be saying the name exactly as it appears on your device.	Say the song or artist name exactly as it is displayed on your device. For example, say "Play Artist Prince" or "Play song Purple Rain".
		Make sure you are saying the complete title such as "California remix featuring Jennifer Nettles".
		If there are any abbreviations in the name, like ESPN or CNN, you have to spell those: "E-S-P-N" or "C-N-N".
The song or artist name may have some special characters that are not being recognized by SYNC 3.	Make sure that song titles, artists, album, and playlists names do not have any special characters like *, - or +.	
SYNC 3 does not understand or is calling the wrong contact when I want to make a call.	You may not be saying the name exactly as it appears on your phone-book.	Make sure that you are saying the name exactly as it appears on your phone. For example, if your contact is "Joe Wilson", say "Call Joe Wilson". If your contact name is "Mom", say "Call Mom".
	The contact name may contain special characters.	Make sure that your contact names do not have any special characters like *, - or +.

## SYNC™ 3 (If Equipped)

<b>Voice command issues</b>		
<b>Issue</b>	<b>Possible cause</b>	<b>Possible solution</b>
The SYNC 3 voice control system is having trouble recognizing foreign names stored on my cell phone.	You may not be saying the name exactly as it appears on your phonebook.	SYNC 3 applies the phonetic pronunciation rules of the selected language to the contact names stored on your cell phone.
		<b>Helpful Hint:</b> You can select your contact manually. Press <b>PHONE</b> . Select the option for phonebook and then contact name. Press the soft-key option to hear it. SYNC 3 will read the contact name to you, giving you some idea of the pronunciation it is expecting.
The SYNC 3 voice control system is having trouble recognizing foreign tracks, artists, albums, genres and playlist names from my media player or USB flash drive.	You may be saying the foreign names using the currently selected language for SYNC 3.	SYNC 3 applies the phonetic pronunciation rules of the selected language to the names stored on your media player or USB flash drive. It is able to make some exceptions for very popular artist names (for example, U2) such that you can always use the English pronunciation for these artists.
The system generates voice prompts and the pronunciation of some words may not be accurate for my language.	SYNC 3 uses text-to-speech voice prompt technology.	SYNC 3 uses a synthetically generated voice rather than pre-recorded human voice.
		SYNC 3 offers several new voice control features for a wide range of languages. Dialing a contact name directly from the phonebook without pre-recording (for example, "call John Smith") or selecting a track, artist, album, genre or playlist directly from your media player (for example, "play artist Madonna").

## SYNCTM 3 (If Equipped)

<b>Personal Profiles</b>	
<b>Issue</b>	<b>Possible cause and solution</b>
I cannot create a profile.	Personal Profiles have not been set up.
	An invalid profile name was entered.
	A memory button was not selected when prompted.
	The vehicle's ignition was not On and in Park or was shifted out of Run or Park while creating a profile.
	Personal Profiles is turned off.
I cannot link a keyfob.	The lock button was not selected on a keyfob when prompted.
	The keyfob selected was already associated to another profile and an overwrite was declined.
	A profile recall was performed while linking a keyfob.
	The vehicle's ignition was not On and in Park, or was shifted out of Run or Park while linking a keyfob.
	The old linking method is used.
My personalized settings do not save.	The unsaved setting is not supported by Personal Profiles.
	A different Personal Profile is active than expected.
	Another user has changed settings for the wrong Personal Profile.
My profile will not recall.	A Personal Profile has not been created.
	Personal Profiles is turned off.
	The requested profile is already active.
	The memory button being used is not linked to a profile.

## SYNC™ 3 (If Equipped)

<b>Personal Profiles</b>	
<b>Issue</b>	<b>Possible cause and solution</b>
	The keyfob being used is not linked to a profile.
	The wrong keyfob is being used.
	A button other than unlock or remote start is being pressed on a linked keyfob.
	The Personal Profile was deleted.
My preset positions recall but my profile does not.	Personal Profiles is turned off.
My profile recalls but my preset positions do not.	The vehicle is in motion.
	The preset positions are the same as the Guest or previously active profile.
I lost a keyfob.	Unlink and relink your keyfob in the Personal Profiles menu. You may need to see your authorized dealer.
I lost all profiles.	Keyfobs had been erased and reprogramed. This could happen if you let dealership add a new keyfob to replace lost one.
	Master Reset had been performed without your acknowledgement.

## SYNC™ 3 (If Equipped)

<b>General</b>		
<b>Issue</b>	<b>Possible cause</b>	<b>Possible solution</b>
<p>The language selected for the instrument cluster and information and entertainment display does not match the SYNC 3 language (phone, USB, Bluetooth audio, voice control and voice prompts).</p>	<p>SYNC 3 does not support the currently selected language for the instrument cluster and information and entertainment display.</p>	<p>SYNC 3 only supports four languages in a single module for text display, voice control and voice prompts. The country where you bought your vehicle dictates the four languages based on the most popular languages spoken. If the selected language is not available, SYNC 3 remains in the current active language.</p> <p>SYNC 3 offers several new voice control features for a wide range of languages. Dialing a contact name directly from the phonebook without pre-recording (for example, "call John Smith") or selecting a track, artist, album, genre or playlist directly from your media player (for example, "play artist Madonna").</p>

<b>SYNC 3 System Reset</b>
<p>The system has a System Reset feature that can be performed if the function of a SYNC 3 feature is lost. This reset is intended to restore functionality and will not erase any information previously stored in the system (such as paired devices, phonebook, call history, text messages, or user settings). To perform a System Reset, press and hold the Seek Up (&gt;&gt; ) button while pressing and holding the Radio Power button. After approximately 5 seconds the screen will go black. Allow 1-2 minutes for the system reset to complete. You may then resume using the SYNC 3 system.</p>

For additional assistance with SYNC 3 troubleshooting, refer to the regional Ford or Lincoln website.



# Accessories

---

For a complete listing of the accessories that are available for your vehicle, please contact your authorized dealer or visit the online store web site:

<b>Web Address (United States)</b>
------------------------------------

<a href="http://www.Accessories.Ford.com">www.Accessories.Ford.com</a>
--

<b>Web Address (Canada)</b>
-----------------------------

<a href="http://www.Accessories.Ford.ca">www.Accessories.Ford.ca</a>
--

Ford Custom Accessories are available for your vehicle through an authorized dealer. Ford Motor Company will repair or replace any properly authorized dealer-installed Ford Original Accessory found to be defective in factory-supplied materials or workmanship during the warranty period, as well as any component damaged by the defective accessories.

Ford Motor Company will warrant your vehicle through the warranty that provides the greatest benefit:

- 24 months, unlimited mileage.
- The remainder of your new vehicle limited warranty.

Contact an authorized dealer for details and a copy of the warranty.

## Exterior style

- Commercial graphics\*
- Commercial LED warning strobe lights\*
- Hood deflectors.
- Exhaust tip.
- Running boards.
- Side window deflectors\*
- Splash guards.
- Stainless-steel wheel covers\*.

- Step bars.
- Wheel well liners.

## Interior style

- Ambient lighting.
- Cargo organizers.
- Custom seat covers\*.
- Floor liners.
- Floor mats.

## Lifestyle

- Ash cup/smoker's package.
- Bed cargo net, tie down plates and cleats.
- Bed extender.
- Bedliners and bedmats.
- Bed ramps.
- Hitches.
- Racks and carriers\*.
- Sportliner cargo liner\*.
- Tonneau/bed cover\*.
- Tow hooks.
- Towing accessories.
- Trailer back-up camera.
- Trailer brake control.
- Truck bed camping tent\*.
- Trailer TPMS.

## Peace of mind

- Back-up alarm\*.
- Bed hooks\*.
- Bumper and hitch-mounted parking sensors\*.
- Ford Telematics.
- Keyless entry keypad.
- Protective seat covers\*.
- Remote start and alarms.
- Roadside assistance kits\*.

# Accessories

---

- Cruise control.
- Tool or Cargo boxes\*:
- Vehicle security system.
- Wheel locks.
- Wheel well liners.

\*The accessory manufacturer designs, develops and therefore warrants Ford Licensed Accessories, and does not design or test these accessories to Ford Motor Company engineering requirements. Contact an authorized Ford dealer for the manufacturer's limited warranty details, and request a copy of the Ford Licensed Accessories product limited warranty from the accessory manufacturer.

For maximum vehicle performance, keep the following information in mind when adding accessories or equipment to your vehicle:

- When adding accessories, equipment, passengers and luggage to your vehicle, do not exceed the total weight capacity of the vehicle or of the front or rear axle (GVWR or GAWR as indicated on the Safety Compliance Certification label). Ask an authorized dealer for specific weight information.
- The Federal Communications Commission (FCC) and Canadian Radio Telecommunications Commission (CRTC) regulate the use of mobile communications systems that are equipped with radio transmitters, for example two-way radios, telephones and theft alarms. Any such equipment installed in your vehicle should comply with Federal Communications Commission (FCC) and Canadian Radio Telecommunications Commission (CRTC) regulations and should be installed only by an authorized dealer.

- An authorized dealer needs to install mobile communications systems. Improper installation may harm the operation of your vehicle, particularly if the manufacturer did not design the mobile communication system specifically for automotive use.
- If you or an authorized Ford dealer add any non-Ford electrical or electronic accessories or components to your vehicle, you may adversely affect battery performance and durability. In addition, you may also adversely affect the performance of other electrical systems in the vehicle.

## **AUXILIARY SWITCHES (If Equipped)**

For maximum vehicle performance, keep the following information in mind when adding accessories or equipment to your vehicle:

- When adding accessories, equipment, passengers and luggage to your vehicle, do not exceed the total weight capacity of the vehicle or of the front or rear axle (GVWR or GAWR as indicated on the Safety Compliance Certification label). Ask an authorized dealer for specific weight information.
- The Federal Communications Commission (FCC) and Canadian Radio Telecommunications Commission (CRTC) regulate the use of mobile communications systems equipped with radio transmitters, for example, two-way radios, telephones and theft alarms. Any such equipment installed in your vehicle should comply with Federal Communications Commission (FCC) and Canadian Radio Telecommunications Commission (CRTC) regulations, and should be installed by an authorized dealer.

## Accessories

- An authorized dealer needs to install mobile communications systems. Improper installation may harm the operation of your vehicle, particularly if the manufacturer did not design the mobile communication system specifically for automotive use.
- If you or an authorized Ford dealer add any non-Ford electrical or electronic accessories or components to your vehicle, you may adversely affect battery performance and durability. In addition, you may also adversely affect the performance of other electrical systems in the vehicle.



E220728

The auxiliary switch option package provides six switches mounted in the overhead console. These switches operate when the vehicle is running or from battery power, depending on the switchable fuse AUXF4's location in the upfitter relay box. We recommend, however, that the engine remain running to maintain battery charge when using the auxiliary switches for extended periods of time or higher current draws.

**Note:** *When your vehicle has a diesel engine, use the auxiliary switches only when the engine is running. The glow plugs also drain battery power when the ignition key is in the on position. Using the auxiliary switches, even for limited amounts of time, can cause your battery to drain quickly and prevent your vehicle from restarting.*

When switched on, the auxiliary switches provide electrical battery power for a variety of personal or commercial uses. Switches 1 through 4 provide 25 amps. Switches 5 and 6 provide 40 amps.

The relay box for the auxiliary switches is in the rear of the engine compartment, near the back wall. See your authorized dealer for service.

The relays are coded as shown:

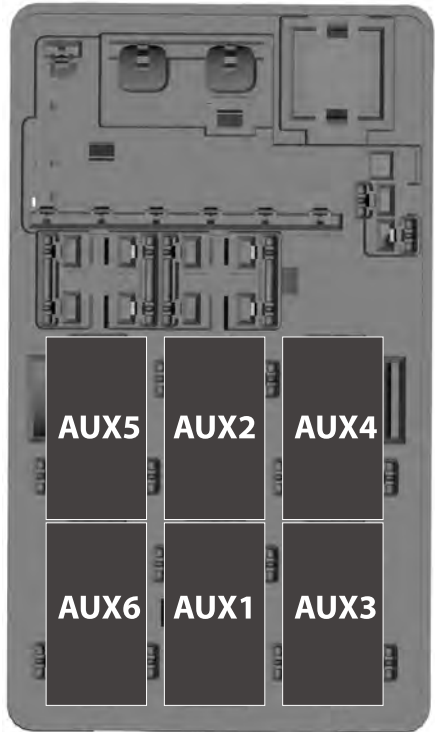

E220729

# Accessories

Each switch includes a blunt-cut, sealed wire. The wires are under the instrument

panel on the right-hand side of the passenger footwell.

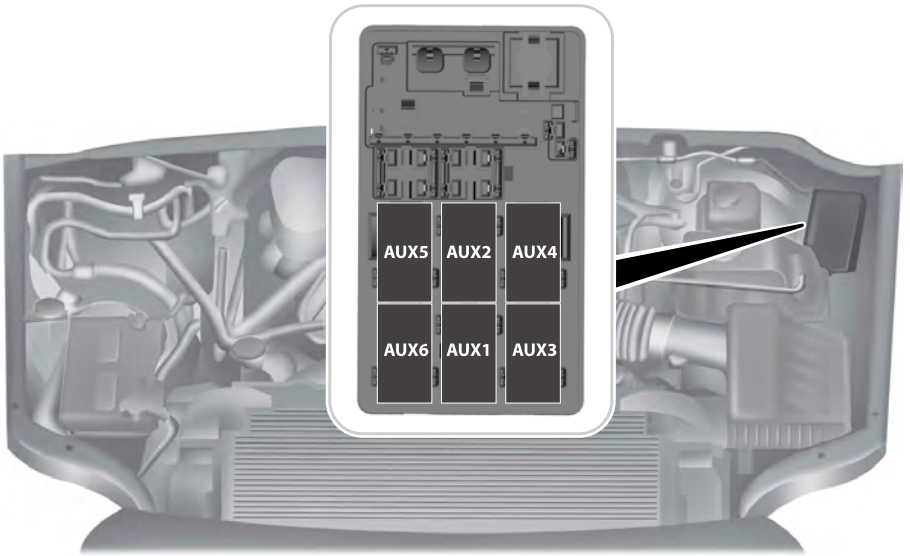

E220730

The power leads are coded as shown:

Switch	Circuit Number	Wire Color	Fuse Amp Rating
AUX 1	CB117A	Brown with green trace	25A
AUX 2	CB114A	Violet with orange trace	25A
AUX 3	CB116A	Blue with green trace	25A

# Accessories

Switch	Circuit Number	Wire Color	Fuse Amp Rating
AUX 4	CB113A	Gray with brown trace	25A
AUX 5	CB115A	Brown with blue trace	40A
AUX 6	CB118A	Gray with orange trace	40A

## Upfitter Interface Module (If Equipped)

The Upfitter Interface Module (UIM) is an electronic control module that operates equipment (such as lift buckets, cranes, motors, salt spreaders and snow plows) with external relays.

If you replace the module, it will require additional programming by the upfitter. Obtain this data directly from the upfitter company. The upfitter contact information is in the vehicle door opening.

For more information on the Upfitter Interface Module and the auxiliary switches, contact your upfitter.

# Ford Protect

---

PROTECT YOURSELF FROM THE RISING COST OF VEHICLE REPAIRS WITH A FORD PROTECT EXTENDED SERVICE PLAN.

## **Ford Protect Extended Service Plans (U.S. Only)**

Ford Protect extended service plan means peace of mind. It's the extended service plan backed by Ford Motor Company, and provides more protection beyond the New Vehicle Limited Warranty coverage. When you visit your Ford Dealer, Insist on Ford Protect extended service plans!

## **Ford Protect Can Quickly Pay for Itself**

One trip to the Service Center could easily exceed the price of your Ford Protect extended service plan. With Ford Protect extended service plan you minimize your risk for unexpected repair bills and rising repair costs.

## **Up to 1,000+ Covered Vehicle Components**

There are four mechanical Ford Protect extended service plans with different levels of coverage. Ask your authorized dealer for details.

1. PremiumCARE - Our most comprehensive coverage. With over 1,000 covered components, this plan is so complete it's probably easier to list what's not covered.
2. ExtraCARE - Covers 113 components, and includes many high-tech items.
3. BaseCARE - Covers 84 components.
4. PowertrainCARE - Covers 29 critical components.

Ford Protect extended service plans are honored by all authorized Ford dealers in the U.S., Canada and Mexico.

That means you get:

- Reliable, quality service at any Ford or Lincoln dealership.
- Repairs performed by factory trained technicians, using genuine parts.

## **Rental Car Reimbursement**

### ***1st day Rental Benefit***

If you bring your car into your dealer for service, we'll give you a loaner to use for the day.

### ***Extended Rental Benefits***

If your vehicle is kept overnight for covered repairs, you are eligible for rental car coverage, including warranty repairs, and Field Service Actions.

## **Roadside Assistance**

Exclusive 24/7 roadside assistance, including:

- Towing, flat-tire change and battery jump starts.
- Out of fuel and lock-out assistance.
- Travel expense reimbursement for lodging, meals and rental car.
- Assistance for taxi, shuttle, rental car coverage or other transportation.

## **Transferable Coverage**

If you sell your vehicle before your Ford Protect extended service plan coverage expires, you can transfer any remaining coverage to the new owner. Which should give you and your potential buyer a little more peace of mind.

# Ford Protect

---

## Less Cost to Properly Maintain Your Vehicle

Ford Protect extended service plan also offers a Premium Maintenance Plan that covers all scheduled maintenance, and selected wear items. The coverage is prepaid, so you never have to worry about the cost of your vehicle's maintenance.

Covered maintenance includes:

- Windshield wiper blades.
- Spark plugs.
- The clutch disc (if equipped).
- Brake pads and linings.
- Shock absorbers.
- Struts.
- Engine Belts.
- Engine coolant hoses, clamps and o-rings.
- Diesel exhaust fluid replenishment (if equipped).
- Cabin air filter replacement every 20,000 mi (32,000 km) (electric vehicles only).

## Interest Free Finance Options

Just a 10% down payment will provide you with an affordable, no interest, no fee payment program allowing you all the security and benefits Ford Protect extended service plan has to offer while paying over time. You are pre-approved with no credit check or hassles. To learn more, call our Ford Protect extended service plan specialists at 800-367-3377.

Ford Protect Extended Service Plan  
P.O. Box 321067  
Detroit, MI 48232

## Ford Protect Extended Service Plan (CANADA ONLY)

You can get more protection for your vehicle by purchasing a Ford Protect extended service plan. Ford Protect extended service plan is the only service contract backed by Ford Motor Company of Canada, Limited. Depending on the plan you purchase, Ford Protect extended service plan provides benefits such as:

- Rental reimbursement.
- Coverage for certain maintenance and wear items.
- Protection against repair costs after your New Vehicle Limited Warranty Coverage expires.
- Roadside Assistance benefits.

There are several Ford Protect extended service plans available in various time, distance and deductible combinations. Each plan is tailored to fit your own driving needs, including reimbursement for towing and rental. When you purchase Ford Protect extended service plan, you receive added peace-of-mind protection throughout Canada, the United States and Mexico, provided by a network of participating authorized Ford Motor Company dealers.

**Note:** *Repairs performed outside of Canada, the United States and Mexico are not eligible for Ford Protect extended service plan coverage.*

This information is subject to change. For more information; visit your local Ford of Canada dealer or [www.ford.ca](http://www.ford.ca) to find the Ford Protect extended service plan that is right for you.

# Scheduled Maintenance

---

## GENERAL MAINTENANCE INFORMATION

### Why Maintain Your Vehicle?

Carefully following the maintenance schedule helps protect against major repair expenses resulting from neglect or inadequate maintenance and may help to increase the value of your vehicle when you sell or trade it. Keep all receipts for completed maintenance with your vehicle.

We have established regular maintenance intervals for your vehicle based upon rigorous testing. It is important that you have your vehicle serviced at the proper times. These intervals serve two purposes; one is to maintain the reliability of your vehicle and the second is to keep your cost of owning your vehicle down.

It is your responsibility to have all scheduled maintenance performed and to make sure that the materials used meet the specifications identified in this owner's manual. See **Capacities and Specifications** (page 420).

Failure to perform scheduled maintenance invalidates warranty coverage on parts affected by the lack of maintenance.

### Why Maintain Your Vehicle at Your Dealership?

#### Factory-Trained Technicians

Service technicians participate in extensive factory-sponsored certification training to help them become experts on the operation of your vehicle. Ask your dealership about the training and certification their technicians have received.

### Genuine Ford and Motorcraft® Replacement Parts

Dealerships stock Ford, Motorcraft and Ford-authorized branded re-manufactured replacement parts. These parts meet or exceed our specifications. Parts installed at your dealership carry a nationwide 24-month or unlimited mile (kilometer) parts and labor limited warranty.

If you do not use Ford authorized parts they may not meet our specifications and depending on the part, it could affect emissions compliance.

### Convenience

Many dealerships have extended evening and Saturday hours to make your service visit more convenient and they offer one stop shopping. They can perform any services that are required on your vehicle, from general maintenance to collision repairs.

**Note:** *Not all dealers have extended hours or body shops. Please contact your dealer for details.*

### Protecting Your Investment

Maintenance is an investment that pays dividends in the form of improved reliability, durability and resale value. To maintain the proper performance of your vehicle and its emission control systems, make sure you have scheduled maintenance performed at the designated intervals.

Your vehicle is equipped with the Intelligent Oil-Life Monitor system, which displays a message in the information display at the proper oil change interval. This interval may be up to one year or 10,000 mi (16,000 km).



# Scheduled Maintenance

---

When the oil change message appears in the information display, it is time for an oil change. Make sure you perform the oil change within two weeks or 500 mi (800 km) of the message appearing. Make sure you reset the Intelligent Oil-Life Monitor after each oil change. See **Oil Change Indicator Reset** (page 337).

If your information display resets prematurely or becomes inoperative, you should perform the oil change interval at six months or 5,000 mi (8,000 km) from your last oil change. Never exceed one year or 10,000 mi (16,000 km) between oil change intervals.

Your vehicle is very sophisticated and built with multiple, complex, performance systems. Every manufacturer develops these systems using different specifications and performance features. That is why it is important to rely upon your dealership to properly diagnose and repair your vehicle.

Ford Motor Company has recommended maintenance intervals for various parts and component systems based upon engineering testing. Ford Motor Company relies upon this testing to determine the most appropriate mileage for replacement of oils and fluids to protect your vehicle at the lowest overall cost to you and recommends against maintenance schedules that deviate from the scheduled maintenance information.

We strongly recommend the use of only genuine Ford, Motorcraft or Ford-authorized re-manufactured replacement parts engineered for your vehicle.

## Additives and Chemicals

This owner's manual and the Ford Workshop Manual list the recommended additives and chemicals for your vehicle. We do not recommend using chemicals or additives not approved by us as part of your vehicle's normal maintenance. Please consult your warranty information.

## Oils, Fluids and Flushing

In many cases, fluid discoloration is a normal operating characteristic and, by itself, does not necessarily indicate a concern or that the fluid needs to be changed. However, a qualified expert, such as the factory-trained technicians at your dealership, should inspect discolored fluids that also show signs of overheating or foreign material contamination immediately.

Make sure to change your vehicle's oils and fluids at the specified intervals or in conjunction with a repair. Flushing is a viable way to change fluid for many vehicle sub-systems during scheduled maintenance. It is critical that systems are flushed only with new fluid that is the same as that required to fill and operate the system or using a Ford-approved flushing chemical.

## Owner Checks and Services

Make sure you perform the following basic maintenance checks and inspections every month or at six-month intervals.

# Scheduled Maintenance

---

<b>Check Every Month</b>
Air filter restriction gauge.
Engine oil level.
Function of all interior and exterior lights.
Tires including the spare for wear and proper pressure.
Windshield washer fluid level.
Fuel and water separator. Drain if necessary or if indicated by the information display.
Holes and slots in the tail pipe to make sure they are functional and clear of debris.

<b>Check Every Six Months</b>
Battery connections. Clean if necessary.
Body and door drain holes for obstructions. Clean if necessary.
Cooling system fluid level and coolant strength.
Door weatherstrips for wear. Lubricate if necessary.
Hinges, latches and outside locks for proper operation. Lubricate if necessary.
Parking brake for proper operation.
Safety belts and seat latches for wear and function.
Safety warning lamps, brake, ABS, airbag and safety belt for operation.
Washer spray and wiper operation. Clean or replace blades as necessary.

## Multi-Point Inspection

In order to keep your vehicle running right, it is important to have the systems on your vehicle checked regularly. This can help identify potential issues and prevent major problems. We recommend having the following multi-point inspection performed at every scheduled maintenance interval to help make sure your vehicle keeps running great.

# Scheduled Maintenance

---

<b>Multi-Point Inspection</b>	
Accessory drive belt(s)	Hazard warning system operation
Battery performance	Horn operation
Engine air filter	Radiator, cooler, heater and air conditioning hoses
Exhaust system	Suspension components for leaks or damage
Exterior lamps operation	Steering and linkage
Fluid levels <sup>1</sup> ; fill if necessary	Tires including the spare for wear and proper pressure <sup>2</sup>
For oil and fluid leaks	Windshield for cracks, chips or pits
Half-shaft dust boots	Washer spray and wiper operation

<sup>1</sup> Brake, coolant recovery reservoir, automatic transmission and window washer

<sup>2</sup> If your vehicle is equipped with a temporary mobility kit, check the tire sealant expiration Use By date on the canister. Replace as needed.

Be sure to ask your dealership service advisor or technician about the multi-point vehicle inspection. It is a comprehensive way to perform a thorough inspection of your vehicle. Your checklist gives you immediate feedback on the overall condition of your vehicle.

## **NORMAL SCHEDULED MAINTENANCE**

# Scheduled Maintenance

## Gasoline Engine

### Normal Maintenance Intervals

<b>7,500 mi (12,000 km) or Six Months Whichever Comes First</b>
Change engine oil and filter.
Rotate tires <sup>1</sup> , inspect tire wear and measure tread depth.
Inspect wheels and related components for abnormal noise, wear, looseness or drag.
Perform multi-point inspection recommended.

<sup>1</sup>Vehicles with dual rear wheels should rotate the front wheels when specified; rear wheels only if unusual wear is noted.

<b>15,000 mi (24,000 km) or 12 Months Whichever Comes First</b>
Inspect automatic transmission fluid level. Consult dealer for requirements.
Inspect brake pads, shoes, rotors, drums, brake linings, hoses and parking brake.
Inspect engine coolant concentration, freeze-point protection, level and hoses.
Inspect exhaust system and heat shields.
Inspect front axle and U-joints. Lubricate if equipped with grease fittings. Four-wheel drive vehicles.
Inspect steering linkage, ball joints, suspension, tie-rod ends, driveshaft and U-joints. Lubricate if equipped with grease fittings.

<b>Other Maintenance Items</b>	
Every 15,000 mi (24,000 km)	Replace cabin air filter.
Every 30,000 mi (48,000 km)	Replace engine air filter.
Every 60,000 mi (96,000 km)	Replace front wheel bearing grease and grease seal if non-sealed bearings are used.
Every 97,000 mi (156,000 km)	Replace spark plugs.
Every 105,000 mi (168,000 km)	Change engine coolant. <sup>1</sup>

# Scheduled Maintenance

Other Maintenance Items	
	Inspect accessory drive belt or belts. <sup>2</sup>
Every 150,000 mi (240,000 km)	Change automatic transmission fluid and filter on 6-speed transmission. Consult dealer for requirements.
	Replace the accessory drive belt or belts if not replaced within the last 100,000 mi (160,000 km).
	Replace front wheel bearings and seals if non-sealed bearings are used.
	Change axle(s) fluid. See exceptions.
	Change transfer case fluid if equipped.

<sup>1</sup> Initial replacement at six years or 105,000 mi (168,000 km), then every three years or 45,000 mi (72,000 km).

<sup>2</sup> If not replaced, inspect the belt or belts every 15,000 mi (24,000 km).

## Diesel Engine

### Intelligent Oil-Life Monitor

Your vehicle has an Intelligent Oil-Life Monitor that determines when you should change the engine oil based on how you use your vehicle. By using several important factors in its calculations, the monitor helps reduce the cost of owning your vehicle and reduces environmental waste at the same time.

This means you do not have to remember to change the oil on a mileage-based schedule. Your vehicle lets you know when an oil change is due by displaying a message in the information display.

The following table provides examples of vehicle use and its impact on oil change intervals. It is a guideline only. Actual oil change intervals depend on several factors and generally decrease with severity of use.

When to Expect the Message Prompting You to Change Your Oil	
Miles (km)	Vehicle Use and Example
7,500–10,000 mi (12,000–16,000 km)	<b>Normal</b>
	Normal commuting with highway driving. No, or moderate, load or towing. Flat to moderately hilly roads. No extended idling.
5,000–7,500 mi (8,000–12,000 km)	<b>Severe</b>
	Moderate to heavy load or towing. Mountainous or off-road conditions.

# Scheduled Maintenance

When to Expect the Message Prompting You to Change Your Oil	
Miles (km)	Vehicle Use and Example
	Extended idling, 200-300 hours. Extended hot or cold operation.
2,500–5,000 mi (4,000–8,000 km)	<b>Extreme</b>
	Maximum load or towing. Extreme hot or cold operation. Use of high sulfur diesel fuel.

**Note:** Use the appropriate special operating condition for maintenance information when using high sulfur diesel fuels, operating your vehicle off-road or in dusty conditions, such as unpaved roads.

**Note:** For every hour that your vehicle idles, it has accumulated the equivalent of approximately 25 mi (40 km).

## Normal Maintenance Intervals

At Every Oil Change Interval as Indicated by the Information Display <sup>1</sup>
Change the engine oil and filter. <sup>2</sup>
Fuel and water separator. Drain if necessary or if indicated by the information display.
Refill the diesel exhaust fluid tank.
Rotate the tires <sup>3</sup> , inspect the tires for wear and measure tread depth.
Perform a multi-point inspection, recommended.
Inspect the air filter restriction gauge. Replace the filter if necessary.
Inspect the automatic transmission fluid level. Consult dealer for requirements.
Inspect the brake pads, shoes, rotors, drums, brake linings, hoses and parking brake.
Inspect the engine and secondary cooling system coolant concentration freeze-point protection, level and hoses.
Inspect the exhaust system and heat shields.

# Scheduled Maintenance

## At Every Oil Change Interval as Indicated by the Information Display<sup>1</sup>

Inspect the front axle and U-joints. Lubricate any grease fittings. Four-wheel drive vehicles.

Inspect the steering linkage, ball joints, suspension, tie-rod ends, driveshaft and U-joints. Lubricate any grease fittings.

<sup>1</sup> Do not exceed one year or 10,000 mi (16,000 km) between service intervals.

<sup>2</sup> Reset the Intelligent Oil-Life Monitor after engine oil and filter changes.

<sup>3</sup> Vehicles with dual rear wheels should rotate the front wheels when specified; rear wheels only if unusual wear is noted.

## Other maintenance items<sup>1</sup>

Every 20,000 mi (32,000 km)	Replace the cabin air filter.
Every 30,000 mi (48,000 km)	Replace the engine-mounted and frame-mounted fuel filters. Inspect the engine and secondary cooling system coolant concentration freeze-point protection, additive corrosion inhibitor strength, coolant level, and hoses. Add coolant additive if necessary.
Every 45,000 mi (72,000 km)	Replace the air inlet foam filter.
Every 60,000 mi (96,000 km)	Replace the front wheel bearing grease and grease seal if using non-sealed bearings. Two-wheel drive vehicles.
At 90,000 mi (144,000 km)	Inspect the accessory drive belt or belts. <sup>2</sup>
Every 100,000 mi (160,000 km)	Change the crankcase ventilation filter element if equipped. Dual rear wheel and incomplete chassis configurations only. Change the engine and secondary cooling system coolant. <sup>3</sup>
Every 150,000 mi (240,000 km)	Change the automatic transmission fluid and filter. Consult dealer for requirements.
	Replace the accessory drive belt or belts if not replaced within the last 100,000 mi (160,000 km)
	Replace the front wheel bearings and seals if using non-sealed bearings. Two-wheel drive vehicles.

# Scheduled Maintenance

Other maintenance items <sup>1</sup>	
	Change axle(s) fluid. See exceptions.
	Change transfer case fluid, if equipped.

<sup>1</sup> You can perform these maintenance items within 3,000 mi (4,800 km) of the last oil change. Do not exceed the designated distance for the interval.

**Note:** When adding coolant additive, do not exceed the specified maximum of 50 fl oz (1.4 L) for the engine and 20 fl oz (473 ml) for the secondary cooling system. Operating the engine with excessive coolant additive may cause overheating which could lead to severe, permanent engine damage.

<sup>2</sup> Perform follow-up inspections every 15,000 mi (24,000 km) after the initial inspection. Replace the belt or belts at 150,000 mi (240,000 km).

<sup>3</sup> Initial replacement is at six years or 105,000 mi (168,000 km), then every three years or 45,000 mi (72,000 km).

## SPECIAL OPERATING CONDITIONS SCHEDULED MAINTENANCE

### Gasoline Engine

If you operate your vehicle primarily in any of the following conditions, you need to perform extra maintenance as indicated.

If you operate your vehicle occasionally under any of these conditions, it is not necessary to perform the extra maintenance. For specific recommendations, see your dealership service advisor or technician.

Towing a Trailer or Using a Car-top Carrier	
Inspect frequently, service as required	Inspect and lubricate U-joints if equipped with grease fittings.
	See axle maintenance items under <b>Exceptions</b> .
Every 5,000 mi (8,000 km)	Inspect the wheels and related components for abnormal noise, wear, looseness or drag.



## Scheduled Maintenance

<b>Towing a Trailer or Using a Car-top Carrier</b>	
	Rotate tires <sup>1</sup> , inspect tires for wear and measure tread depth.
Every 5,000 mi (8,000 km) or six months.	Change engine oil and filter.
	Inspect and lubricate U-joints if equipped with grease fittings.
Every 30,000 mi (48,000 km)	Replace front wheel bearing grease and grease seals if non-sealed bearings are used.
Every 60,000 mi (96,000 km)	Change transfer case fluid (Four-wheel drive vehicles).
	Replace spark plugs.

<sup>1</sup>Vehicles with dual rear wheels should rotate the front wheels when specified; rear wheels only if unusual wear is noted.

<b>Extensive Idling or Low-speed Driving for Long Distances, as in Heavy Commercial Use (Such as Delivery, Taxi, Patrol Car or Livery)</b>	
Inspect frequently, service as required	Replace engine air filter.
	Replace cabin air filter.
Every 5,000 mi (8,000 km)	Inspect brake system.
	Inspect wheels and related components for abnormal noise, wear, looseness or drag.
	Lubricate control arm and steering ball joints if equipped with grease fittings.
	Rotate tires <sup>1</sup> , inspect tires for wear and measure tread depth.
Every 5,000 mi (8,000 km) or six months	Inspect and lubricate U-joints if equipped with grease fittings.
Every 5,000 mi (8,000 km) or six months or 200 engine hours.	Change engine oil and filter.

## Scheduled Maintenance

<b>Extensive Idling or Low-speed Driving for Long Distances, as in Heavy Commercial Use (Such as Delivery, Taxi, Patrol Car or Livery)</b>	
Every 30,000 mi (48,000 km)	Replace front wheel bearing grease and grease seals if non-sealed bearings are used.
Every 60,000 mi (96,000 km)	Replace spark plugs.

<sup>1</sup>Vehicles with dual rear wheels should rotate the front wheels when specified; rear wheels only if unusual wear is noted.

<b>Operating in Dusty or Sandy Conditions (Such as Unpaved or Dusty Roads)</b>	
Inspect frequently, service as required	Replace engine air filter.
	Replace cabin air filter.
Every 5,000 mi (8,000 km)	Inspect the wheels and related components for abnormal noise, wear, looseness or drag.
	Rotate tires <sup>1</sup> , inspect tires for wear and measure tread depth.
Every 5,000 mi (8,000 km) or six months	Change engine oil and filter.
	Inspect and lubricate U-joints if equipped with grease fittings.
Every 30,000 mi (48,000 km)	Replace front wheel bearing grease and grease seals if non-sealed bearings are used.

<sup>1</sup>Vehicles with dual rear wheels should rotate the front wheels when specified; rear wheels only if unusual wear is noted.

<b>Off-road operation</b>	
Inspect frequently, service as required	Inspect steering linkage, ball joints and U-joints, Lubricate if equipped with grease fittings.
	Replace engine air filter.
Every 5,000 mi (8,000 km) or six months	Change engine oil and filter.
	Replace cabin air filter.
	Inspect the wheels and related components for abnormal noise, wear, looseness or drag.

## Scheduled Maintenance

<b>Off-road operation</b>	
	Rotate tires <sup>1</sup> , inspect tires for wear and measure tread depth.
Every 30,000 mi (48,000 km)	Replace front wheel bearing grease and grease seals if non-sealed bearings are used.

<sup>1</sup>Vehicles with dual rear wheels should rotate the front wheels when specified; rear wheels only if unusual wear is noted.

<b>Exclusive use of E85 (Flex Fuel Vehicles Only)</b>	
Every oil change interval	If ran exclusively on E85, fill the fuel tank full with regular unleaded fuel.

### Diesel Engine

If you operate your vehicle primarily in any of the following conditions, you need to perform extra maintenance as indicated.

If you operate your vehicle occasionally under any of these conditions, it is not necessary to perform the extra maintenance. For specific recommendations, see your dealership service advisor or technician.

<b>Towing a Trailer or Using a Car-top Carrier</b>	
As required	Change the engine oil and filter as indicated by the information display, and perform the services listed in the scheduled maintenance chart.
	See the axle maintenance items under <b>Exceptions</b> .
Every 15,000 mi (24,000 km) or six months, 600 engine hours	Replace the engine-mounted and frame-mounted fuel filters.
Every 30,000 mi (48,000 km)	Replace the wheel bearing grease and grease seals if using non-sealed bearings. (Two-wheel drive vehicles)

## Scheduled Maintenance

Towing a Trailer or Using a Car-top Carrier	
Every 30,000 mi (48,000 km) or 1200 engine hours	Inspect the engine and secondary cooling system coolant concentration (freeze-point protection) and additive (corrosion inhibitor) strength. Add coolant additive if necessary.
Every 60,000 mi (96,000 km) or 2400 engine hours	Flush and refill the coolant. Do not add coolant additive.

**Note:** When adding coolant additive, do not exceed the specified maximum of 50 fl oz (1.4 L) for the engine and 20 fl oz (473 ml) for the secondary cooling system. Operating the engine with excessive coolant additive may cause overheating which could lead to severe, permanent engine damage.

**Note:** After the initial coolant flush and fill at 60,000 mi (96,000 km) or 2400 engine hours, flush and fill every 45,000 mi (72,000 km) or 1800 engine hours thereafter.

Frequent or Extended Idling (Over 10 Minutes Per Hour of Normal Driving) or Frequent Low-speed Operation if your Vehicle is Used for Stationary Operation	
As required	Change the engine oil and filter as indicated by the information display, and perform the services listed in the scheduled maintenance chart.
Every 15,000 mi (24,000 km), six months or 600 engine hours	Replace the engine-mounted and frame-mounted fuel filters.
Every 30,000 mi (48,000 km) or 1200 engine hours	Inspect the engine and secondary cooling system coolant concentration (freeze-point protection) and additive (corrosion inhibitor) strength. Add coolant additive if necessary.
Every 60,000 mi (96,000 km) or 2400 engine hours	Flush and refill the coolant. Do not add coolant additive.

**Note:** When adding coolant additive, do not exceed the specified maximum of 50 fl oz (1.4 L) for the engine and 20 fl oz (473 ml) for the secondary cooling system. Operating the engine with excessive coolant additive may cause overheating which could lead to severe, permanent engine damage.

**Note:** After the initial coolant flush and fill at 60,000 mi (96,000 km) or 2400 engine hours, flush and fill every 45,000 mi (72,000 km) or 1800 engine hours thereafter.

## Scheduled Maintenance

<b>Frequent Low-speed Operation, Consistent Heavy Traffic Under 25 mph (40 km/h) or Long Rush-hour Traffic</b>	
As required	Change the engine oil and filter as indicated by the information display, and perform the services listed in the scheduled maintenance chart.
Every 15,000 mi (24,000 km), six months or 600 engine hours	Replace the engine-mounted and frame-mounted fuel filters.
Every 30,000 mi (48,000 km) or 1200 engine hours	Inspect the engine and secondary cooling system coolant concentration (freeze-point protection) and additive (corrosion inhibitor) strength. Add coolant additive if necessary.
Every 60,000 mi (96,000 km) or 2400 engine hours	Flush and refill the coolant. Do not add coolant additive.

**Note:** When adding coolant additive, do not exceed the specified maximum of 50 fl oz (1.4 L) for the engine and 20 fl oz (473 ml) for the secondary cooling system. Operating the engine with excessive coolant additive may cause overheating which could lead to severe, permanent engine damage.

**Note:** After the initial coolant flush and fill at 60,000 mi (96,000 km) or 2400 engine hours, flush and fill every 45,000 mi (72,000 km) or 1800 engine hours thereafter.

<b>Sustained High-speed Driving at Gross Vehicle Weight Rating (Maximum Loaded Weight for Vehicle Operation)</b>	
As required	Change the engine oil and filter as indicated by the information display, and perform the services listed in the scheduled maintenance chart.
Every 15,000 mi (24,000 km), six months or 600 engine hours	Replace the engine-mounted and frame-mounted fuel filters.
Every 30,000 mi (48,000 km)	Replace the wheel bearing grease and grease seals if using non-sealed bearings. (Two-wheel drive vehicles)

## Scheduled Maintenance

<b>Sustained High-speed Driving at Gross Vehicle Weight Rating (Maximum Loaded Weight for Vehicle Operation)</b>	
Every 30,000 mi (48,000 km) or 1200 engine hours	Inspect the engine and secondary cooling system coolant concentration (freeze-point protection) and additive (corrosion inhibitor) strength. Add coolant additive if necessary.
Every 60,000 mi (96,000 km) or 2400 engine hours	Flush and refill the coolant. Do not add coolant additive.

**Note:** When adding coolant additive, do not exceed the specified maximum of 48 fluid ounces (1.4 liters) for the engine and 16 fluid ounces (473 ml) for the secondary cooling system. Operating the engine with excessive coolant additive may cause overheating which could lead to severe, permanent engine damage.

**Note:** After the initial coolant flush and fill at 60,000 mi (96,000 km) or 2400 engine hours, flush and fill every 45,000 mi (72,000 km) or 1800 engine hours thereafter.

<b>Operating in Sustained Ambient Temperatures Below -9°F (-23°C) or Above 100°F (38°C)</b>	
As required	Change the engine oil and filter as indicated by the information display, and perform the services listed in the scheduled maintenance chart.
Every 15,000 mi (24,000 km), six months or 600 engine hours	Replace the engine-mounted and frame-mounted fuel filters.
Every 30,000 mi (48,000 km)	Replace the wheel bearing grease and grease seals if using non-sealed bearings. (Two-wheel drive vehicles)

<b>Operating in Dusty or Sandy Conditions (Such as Unpaved or Dusty Roads)</b>	
Every 7,500 mi (12,000 km)	Rotate the tires <sup>1</sup> , inspect the tires for wear and measure tread depth.
	Inspect the brake system pads and rotors.
	Inspect the air filter restriction gauge. Replace the filter if necessary.
	Inspect the steering and suspension ball joints and tie rods. Lubricate any grease fittings.

## Scheduled Maintenance

<b>Operating in Dusty or Sandy Conditions (Such as Unpaved or Dusty Roads)</b>	
Every 7,500 mi (12,000 km), six months or 300 engine hours	Change the engine oil and filter. <sup>2</sup>
	Inspect and lubricate the U-joints.
Every 15,000 mi (24,000 km), 6 months or 600 engine hours	Replace the engine-mounted and frame-mounted fuel filters.
Every 30,000 mi (48,000 km)	Replace the air inlet foam filter.
	Replace the wheel bearing grease and grease seals if using non-sealed bearings. (Two-wheel drive vehicles)

<sup>1</sup>Vehicles with dual rear wheels should rotate the front wheels when specified; rear wheels only if unusual wear is noted.

<sup>2</sup>Reset the Intelligent Oil-Life Monitor after engine oil and filter changes.

<b>Off-road Operation</b>	
As required	Inspect functional holes in each leg of the twin exhaust tips and the holes under the shield just inboard of the right rear tire to make sure they are clean and clear of debris or foreign materials. Refer to the Vehicle Care chapter of your owner's manual for more information.
	Inspect the steering and suspension ball joints and tie rods. Lubricate any grease fittings.
Every 7,000 mi (12,000 km), six months or 300 engine hours	Rotate the tires <sup>1</sup> , inspect the tires for wear and measure tread depth.
	Inspect the brake system pads and rotors.
	Inspect the air filter restriction gauge. Replace the filter if necessary.
Every 7,000 mi (12,000 km) or 300 engine hours	Change the engine oil and filter. <sup>2</sup>
Every 15,000 mi (24,000 km), six months or 600 engine hours	Replace the engine-mounted and frame-mounted fuel filters.
Every 30,000 mi (48,000 km)	Replace the air inlet foam filter.
	Replace the wheel bearing grease and grease seals if using non-sealed bearings. (Two-wheel drive vehicles).

# Scheduled Maintenance

<b>Off-road Operation</b>	
Every 50,000 mi (80,000 km)	Change the rear axle fluid (Dana rear axles only - some F-350s; all F-450s and F-550s).
	Change the transfer case fluid. (Four-wheel drive vehicles)
	Inspect the front axle fluid. (Four-wheel drive vehicles)

<sup>1</sup>Vehicles with dual rear wheels should rotate the front wheels when specified; rear wheels only if unusual wear is noted.

<sup>2</sup>Reset the Intelligent Oil-Life Monitor after engine oil and filter changes.

<b>Using Biodiesel, up to and Including 20% Biodiesel (B20)</b>	
As required	Change the engine oil and filter as indicated by the information display, and perform the services listed in the scheduled maintenance chart.
Every 15,000 mi (24,000 km), six months or 300 engine hours	Replace the engine-mounted and frame-mounted fuel filters.

<b>Using Fuel Other Than Ultra-low Sulfur Diesel Fuel - Vehicles Operated Where Ultra-low Sulfur Diesel Fuel is not Required or Available</b>	
Every 2,500 mi (4,000 km) or three months (if using high sulfur fuel with more than 500 ppm sulfur)	Change engine oil and filter.
Every 5,000 mi (8,000 km) or six months (if using high sulfur fuel with fewer than 500 ppm sulfur)	Change engine oil and filter.

## Exceptions

### Axle and Transfer Case Maintenance

Axle(s) and transfer case (4X4 only) fluid changes or level checks are not required unless a leak is suspected or the assembly has been submerged in water. During long periods of trailer towing with outside temperatures above 70°F (21°C) or at

wide-open throttle for long periods above 45 mph (72 km/h), change the rear axle fluid every 30,000 mi (48,000 km) if the rear axle is filled with non-synthetic fluid. This interval can be waived and the 150,000 mi (240,000 km) service interval can continue if the rear axle is filled with 75W140 synthetic gear fluid meeting Ford



# Scheduled Maintenance

---

specification WSL-M2C192-A, part number XY-75W140-QL, or equivalent. Add friction modifier XL-3 (EST-M2C118-A) or equivalent for complete refill of Traction-Lok rear axles. See **Capacities and Specifications** (page 420).

## **Additional Axle Maintenance for Dual Rear Wheels**

Change rear axle fluid every 250,000 mi (400,000 km) under normal driving conditions on all commercial applications. When operating your vehicle at or near maximum gross vehicle weights, change the rear axle fluid every 60,000 mi (96,000 km). In addition, follow this 60,000 mi (96,000 km) schedule when operating your vehicle under the special operating conditions where noted.

## **California Fuel Filter Replacement**

If you register your vehicle in California, the California Air Resources Board has determined that the failure to perform this maintenance item does not nullify the emission warranty or limit recall liability before the completion of your vehicle's useful life. Ford Motor Company, however, urges you to have all recommended maintenance services performed at the specified intervals and to record all vehicle service.

## **Hot Climate Oil Change Intervals**

Vehicles operating in the Middle East, North Africa, Sub-Saharan Africa or locations with similar climates using an American Petroleum Institute (API) Certified for Gasoline Engines (Certification mark) oil of SM or SN quality, the normal oil change interval is 3,000 mi (5,000 km).

If the available API SM or SN oils are not available, then the oil change interval is 2,000 mi (3,000 km).

## **Engine Air Filter and Cabin Air Filter Replacement**

The life of the engine air filter and cabin air filter is dependent on exposure to dusty and dirty conditions. Vehicles operated in these conditions require frequent inspection and replacement of the engine air filter and cabin air filter.

## **Diesel Particulate Filter**

Over time, a slight amount of ash builds up in the diesel particulate filter, which is not removed during the regeneration process. The filter may need to be replaced with a new or remanufactured part at approximately 250,000 mi (400,000 km). Actual mileage varies depending on engine and vehicle operating conditions.

In this case, the engine control system sets a service light (wrench icon) to inform you to bring your vehicle to the dealer for service. If there are any issues with the oxidation catalyst or particulate filter system, a service light (wrench or engine icon) sets by the engine control system to inform you to bring your vehicle into a dealer for service.

## **SCHEDULED MAINTENANCE RECORD**

# Scheduled Maintenance

<input type="radio"/> Repair Order #:	<p>Dealer stamp</p>
<input type="radio"/> Distance:	
<input type="radio"/> Engine hours (optional):	
<input type="radio"/> Multi-point inspection (recommended): <input type="checkbox"/>	
<input type="radio"/> Signature:	

<input type="radio"/> Repair Order #:	<p>Dealer stamp</p>
<input type="radio"/> Distance:	
<input type="radio"/> Engine hours (optional):	
<input type="radio"/> Multi-point inspection (recommended): <input type="checkbox"/>	
<input type="radio"/> Signature:	

# Scheduled Maintenance

<input type="radio"/> Repair Order #:	<p>Dealer stamp</p>
<input type="radio"/> Distance:	
<input type="radio"/> Engine hours (optional):	
<input type="radio"/> Multi-point inspection (recommended): <input type="checkbox"/>	
<input type="radio"/> Signature:	

<input type="radio"/> Repair Order #:	<p>Dealer stamp</p>
<input type="radio"/> Distance:	
<input type="radio"/> Engine hours (optional):	
<input type="radio"/> Multi-point inspection (recommended): <input type="checkbox"/>	
<input type="radio"/> Signature:	

# Scheduled Maintenance

---

<input type="radio"/> Repair Order #:	<p>Dealer stamp</p>
<input type="radio"/> Distance:	
<input type="radio"/> Engine hours (optional):	
<input type="radio"/> Multi-point inspection (recommended): <input type="checkbox"/>	
<input type="radio"/> Signature:	

<input type="radio"/> Repair Order #:	<p>Dealer stamp</p>
<input type="radio"/> Distance:	
<input type="radio"/> Engine hours (optional):	
<input type="radio"/> Multi-point inspection (recommended): <input type="checkbox"/>	
<input type="radio"/> Signature:	

# Scheduled Maintenance

<input type="radio"/> Repair Order #:	<p>Dealer stamp</p>
<input type="radio"/> Distance:	
<input type="radio"/> Engine hours (optional):	
<input type="radio"/> Multi-point inspection (recommended): <input type="checkbox"/>	
<input type="radio"/> Signature:	

<input type="radio"/> Repair Order #:	<p>Dealer stamp</p>
<input type="radio"/> Distance:	
<input type="radio"/> Engine hours (optional):	
<input type="radio"/> Multi-point inspection (recommended): <input type="checkbox"/>	
<input type="radio"/> Signature:	

# Scheduled Maintenance

---

<input type="radio"/> Repair Order #:	<p>Dealer stamp</p>
<input type="radio"/> Distance:	
<input type="radio"/> Engine hours (optional):	
<input type="radio"/> Multi-point inspection (recommended): <input type="checkbox"/>	
<input type="radio"/> Signature:	

<input type="radio"/> Repair Order #:	<p>Dealer stamp</p>
<input type="radio"/> Distance:	
<input type="radio"/> Engine hours (optional):	
<input type="radio"/> Multi-point inspection (recommended): <input type="checkbox"/>	
<input type="radio"/> Signature:	

# Scheduled Maintenance

<input type="radio"/> Repair Order #:	Dealer stamp
<input type="radio"/> Distance:	
<input type="radio"/> Engine hours (optional):	
<input type="radio"/> Multi-point inspection (recommended): <input type="checkbox"/>	
<input type="radio"/> Signature:	

<input type="radio"/> Repair Order #:	Dealer stamp
<input type="radio"/> Distance:	
<input type="radio"/> Engine hours (optional):	
<input type="radio"/> Multi-point inspection (recommended): <input type="checkbox"/>	
<input type="radio"/> Signature:	

# Scheduled Maintenance

---

<input type="radio"/> Repair Order #:	<p>Dealer stamp</p>
<input type="radio"/> Distance:	
<input type="radio"/> Engine hours (optional):	
<input type="radio"/> Multi-point inspection (recommended): <input type="checkbox"/>	
<input type="radio"/> Signature:	

<input type="radio"/> Repair Order #:	<p>Dealer stamp</p>
<input type="radio"/> Distance:	
<input type="radio"/> Engine hours (optional):	
<input type="radio"/> Multi-point inspection (recommended): <input type="checkbox"/>	
<input type="radio"/> Signature:	



# Scheduled Maintenance

<input type="radio"/> Repair Order #:	Dealer stamp
<input type="radio"/> Distance:	
<input type="radio"/> Engine hours (optional):	
<input type="radio"/> Multi-point inspection (recommended): <input type="checkbox"/>	
<input type="radio"/> Signature:	

<input type="radio"/> Repair Order #:	Dealer stamp
<input type="radio"/> Distance:	
<input type="radio"/> Engine hours (optional):	
<input type="radio"/> Multi-point inspection (recommended): <input type="checkbox"/>	
<input type="radio"/> Signature:	

# Scheduled Maintenance

<input type="radio"/> Repair Order #:	<p>Dealer stamp</p>
<input type="radio"/> Distance:	
<input type="radio"/> Engine hours (optional):	
<input type="radio"/> Multi-point inspection (recommended): <input type="checkbox"/>	
<input type="radio"/> Signature:	

<input type="radio"/> Repair Order #:	<p>Dealer stamp</p>
<input type="radio"/> Distance:	
<input type="radio"/> Engine hours (optional):	
<input type="radio"/> Multi-point inspection (recommended): <input type="checkbox"/>	
<input type="radio"/> Signature:	

# Scheduled Maintenance

<input type="radio"/> Repair Order #:	Dealer stamp
<input type="radio"/> Distance:	
<input type="radio"/> Engine hours (optional):	
<input type="radio"/> Multi-point inspection (recommended): <input type="checkbox"/>	
<input type="radio"/> Signature:	

<input type="radio"/> Repair Order #:	Dealer stamp
<input type="radio"/> Distance:	
<input type="radio"/> Engine hours (optional):	
<input type="radio"/> Multi-point inspection (recommended): <input type="checkbox"/>	
<input type="radio"/> Signature:	

# Appendices

## ELECTROMAGNETIC COMPATIBILITY

### WARNINGS



Do not place objects or mount equipment on or near the airbag cover, on the side of the seatbacks (of the front seats), or in front seat areas that may come into contact with a deploying airbag. Failure to follow these instructions may increase the risk of personal injury in the event of a crash.



Do not fasten antenna cables to original vehicle wiring, fuel pipes and brake pipes.



Keep antenna and power cables at least 4 in (10 cm) from any electronic modules and airbags.

**Note:** We test and certify your vehicle to meet electromagnetic compatibility legislation (UNECE Regulation 10 or other applicable local requirements). It is your responsibility to make sure that any equipment an authorized dealer installs on your vehicle complies with applicable local legislation and other requirements.

**Note:** Any radio frequency transmitter equipment in your vehicle (such as cellular telephones and amateur radio transmitters) must keep to the parameters in the following table. We do not provide special provisions or conditions for installations or use.

### Car

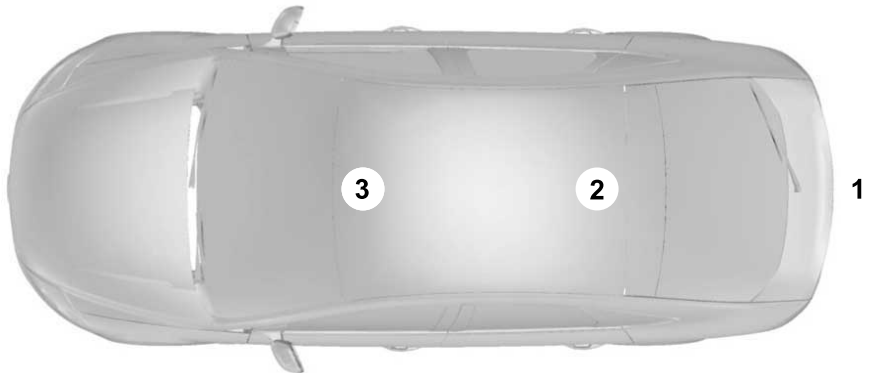

E239120

# Appendices

---

## Van

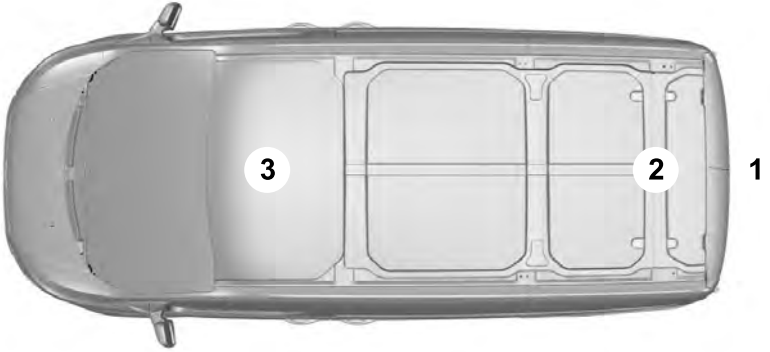

E239122

## Truck

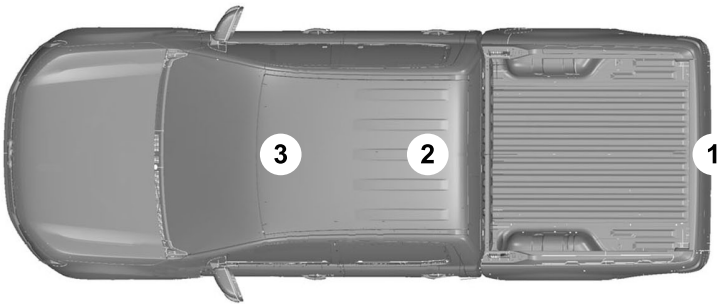

E239121

# Appendices

Frequency Band MHz	Maximum output power Watt (Peak RMS)	Antenna Positions
1-30	50	1
50-54	50	2, 3
68-88	50	2, 3
142-176	50	2, 3
380-512	50	2, 3
806-870	10	2, 3

**Note:** After the installation of radio frequency transmitters, check for disturbances from and to all electrical equipment in your vehicle, both in the standby and transmit modes.

Check all electrical equipment:

- With the ignition ON.
- With the engine running.
- During a road test at various speeds.

Check that electromagnetic fields generated inside your vehicle cabin by the transmitter installed do not exceed applicable human exposure requirements.

## END USER LICENSE AGREEMENT

### VEHICLE SOFTWARE END USER LICENSE AGREEMENT (EULA)

- You ("You" or "Your" as applicable) have acquired a vehicle having several devices, including SYNC ® and various control modules, ("DEVICES") that include software licensed or owned by Ford Motor Company and its affiliates ("FORD MOTOR COMPANY"). Those software products of FORD MOTOR COMPANY origin, as well as associated media, printed materials, and "online" or electronic documentation ("SOFTWARE") are protected by international intellectual property laws and treaties. The SOFTWARE is licensed, not sold. All rights reserved.
- The SOFTWARE may interface with and/or communicate with, or may be later upgraded to interface with and/or communicate with additional software and/or systems provided by FORD MOTOR COMPANY.

# Appendices

---

**IF YOU DO NOT AGREE TO THIS END USER LICENSE AGREEMENT ("EULA") DO NOT USE THE DEVICES OR COPY THE SOFTWARE. ANY USE OF THE SOFTWARE, INCLUDING BUT NOT LIMITED TO USE ON THE DEVICES, WILL CONSTITUTE YOUR AGREEMENT TO THIS EULA (OR RATIFICATION OF ANY PREVIOUS CONSENT).**

**GRANT OF SOFTWARE LICENSE:** This EULA grants you the following license:

- You may use the SOFTWARE as installed on the DEVICES and as otherwise interfacing with systems and/or services provide by or through FORD MOTOR COMPANY or its third party software and service providers.

## **Description of Other Rights and Limitations**

- **Speech Recognition:** If the SOFTWARE includes speech recognition component(s), you should understand that speech recognition is an inherently statistical process and that recognition errors are inherent in the process. Neither FORD MOTOR

COMPANY nor its suppliers shall be liable for any damages arising out of errors in the speech recognition process. It is your responsibility to monitor any speech recognition functions included in the system.

- **Limitations on Reverse Engineering, Decompilation and Disassembly:**

You may not reverse engineer, decompile, translate, disassemble or attempt to discover any source code or underlying ideas or algorithms of the SOFTWARE nor permit others to reverse engineer, decompile or disassemble the SOFTWARE, except and only to the extent that such activity is expressly permitted by applicable law notwithstanding this limitation or to the extent as may be permitted by the licensing terms governing use of any open source components included with the SOFTWARE.

- **Limitations on Distributing, Copying, Modifying and Creating Derivative Works:**

You may not distribute, copy, make modifications to or create derivative works based on the SOFTWARE, except and only to the extent that such activity is expressly permitted by applicable law notwithstanding this limitation or to the extent as may be permitted by the licensing terms governing use of any open source components included with the SOFTWARE.

- **Single EULA:** The end user documentation for the DEVICES and related systems and services may contain multiple EULAs, such as multiple translations and/or multiple media versions (e.g., in the user documentation and in the software). Even if you receive multiple EULAs, you are licensed to use only one (1) copy of the SOFTWARE.

# Appendices

---

- **SOFTWARE Transfer:** You may permanently transfer your rights under this EULA only as part of a sale or transfer of the DEVICES, provided you retain no copies, you transfer all of the SOFTWARE (including all component parts, the media and printed materials, any upgrades, and, if applicable, the Certificate(s) of Authenticity), and the recipient agrees to the terms of this EULA. If the SOFTWARE is an upgrade, any transfer must include all prior versions of the SOFTWARE.
- **Termination:** Without prejudice to any other rights, FORD MOTOR COMPANY may terminate this EULA if you fail to comply with the terms and conditions of this EULA.
- **Internet-Based Services Components:** The SOFTWARE may contain components that enable and facilitate the use of certain Internet-based services. You acknowledge and agree that FORD MOTOR COMPANY, third party software and service suppliers, its affiliates and/or its designated agent may automatically check the version of the SOFTWARE and/or its components that you are utilizing and may provide upgrades or supplements to the SOFTWARE that may be automatically downloaded to your DEVICES.
- **Additional Software/Services:** The SOFTWARE may permit FORD MOTOR COMPANY, third party software and service suppliers, its affiliates and/or its designated agent to provide or make available to you SOFTWARE updates, supplements, add-on components, or Internet-based services components of the SOFTWARE after the date you obtain your initial copy of the SOFTWARE ("Supplemental Components".) SOFTWARE updates may cause you to incur additional charges from your wireless service provider. If FORD MOTOR COMPANY or third party software and services suppliers provide or make available to you Supplemental Components and no other EULA terms are provided along with the Supplemental Components, then the terms of this EULA shall apply. FORD MOTOR COMPANY, its affiliates and/or its designated agent reserve the right to discontinue without liability any Internet-based services provided to you or made available to you through the use of the SOFTWARE.
- **Links to Third Party Sites:** The SOFTWARE may provide you with the ability to link to third party sites. The third party sites are not under the control of FORD MOTOR COMPANY, its affiliates and/or its designated agent. Neither FORD MOTOR COMPANY nor its affiliates nor its designated agent are responsible for (i) the contents of any third party sites, any links contained in third party sites, or any changes or updates to third party sites, or (ii) webcasting or any other form of transmission received from any third party sites. If the SOFTWARE provides links to third party sites, those links are provided to you only as a convenience, and the inclusion of any link does not imply an endorsement of the third party site by FORD MOTOR COMPANY, its affiliates and/or its designated agent.
- **Obligation to Drive Responsibly:** You recognize your obligation to drive responsibly and keep attention on the road. You will read and abide with the DEVICES operating instructions particularly as they pertain to safety and you agree to assume any risk associated with the use of the DEVICES.



# Appendices

---

## **UPGRADES AND RECOVERY MEDIA:**

If the SOFTWARE is provided by FORD MOTOR COMPANY separate from the DEVICES on media such as a ROM chip, CD ROM disk(s) or via web download or other means, and is labeled "For Upgrade Purposes Only" or "For Recovery Purposes Only" you may install one (1) copy of such SOFTWARE onto the DEVICES as a replacement copy for the existing SOFTWARE, and use it in accordance with this EULA, including any additional EULA terms accompanying the upgrade SOFTWARE.

## **INTELLECTUAL PROPERTY RIGHTS:**

All title and intellectual property rights in and to the SOFTWARE (including but not limited to any images, photographs, animations, video, audio, music, text and "applets" incorporated into the SOFTWARE), the accompanying printed materials, and any copies of the SOFTWARE, are owned by FORD MOTOR COMPANY, or its affiliates or suppliers. The SOFTWARE is licensed, not sold. You may not copy the printed materials accompanying the SOFTWARE. All title and intellectual property rights in and to the content which may be accessed through use of the SOFTWARE is the property of the respective content owner and may be protected by applicable copyright or other intellectual property laws and treaties. This EULA grants you no rights to use such content outside its intended use. All rights not specifically granted under this EULA are reserved by FORD MOTOR COMPANY, its affiliates, and third party software and service providers and suppliers. Use of any on-line services which may be accessed through the SOFTWARE may be governed by the respective terms of use relating to such services. If this SOFTWARE contains documentation that is provided only in electronic form, you may print one copy of such electronic documentation.

**EXPORT RESTRICTIONS:** You acknowledge that the SOFTWARE is subject to U.S. and European Union export jurisdiction. You agree to comply with all applicable international and national laws that apply to the SOFTWARE, including the U.S. Export Administration Regulations, as well as end-user, end-use and destination restrictions issued by U.S. and other governments.

**TRADEMARKS:** This EULA does not grant you any rights in connection with any trademarks or service marks of FORD MOTOR COMPANY, its affiliates, and third party software and service providers.

**PRODUCT SUPPORT:** Please refer to FORD MOTOR COMPANY instructions provided in the documentation for the DEVICES product support, such as the vehicle owner guide.

Should you have any questions concerning this EULA, or if you desire to contact FORD MOTOR COMPANY for any other reason, please refer to the address provided in the documentation for the DEVICES.

## **No Liability for Certain Damages:**

EXCEPT AS PROHIBITED BY LAW, FORD MOTOR COMPANY, ANY THIRD PARTY SOFTWARE OR SERVICES SUPPLIERS, AND THEIR AFFILIATES SHALL HAVE NO LIABILITY FOR ANY INDIRECT, SPECIAL, CONSEQUENTIAL OR INCIDENTAL DAMAGES ARISING FROM OR IN CONNECTION WITH THE USE OR PERFORMANCE OF THE SOFTWARE. THIS LIMITATION SHALL APPLY EVEN IF ANY REMEDY FAILS OF ITS ESSENTIAL PURPOSE. THERE ARE NO WARRANTIES OTHER THAN THOSE THAT MAY BE EXPRESSLY PROVIDED FOR YOUR NEW VEHICLE.

# Appendices

---

## **SYNC® Automotive Important Safety Information Read and follow instructions:**

- Before using your SYNC® system, read and follow all instructions and safety information provided in this end user manual ("Owner Guide".) Not following precautions found in the Owner Guide can lead to an accident or other serious injuries.

### General Operation

- **Voice Command Control:** Certain functions within the SYNC® system may be accomplished using voice commands. Using voice commands while driving helps you to operate the system without removing your hands from the wheel or eyes from the road.
- **Prolonged Views of Screen:** Do not access any function requiring a prolonged view of the screen while you are driving. Pull over in a safe and legal manner before attempting to access a function of the system requiring prolonged attention.
- **Volume Setting:** Do not raise the volume excessively. Keep the volume at a level where you can still hear outside traffic and emergency signals while driving. Driving while unable to hear these sounds could cause an accident.
- **Navigation Features:** Any navigation features included in the system are intended to provide turn by turn instructions to get you to a desired destination. Please make certain all persons using this system carefully read and follow instructions and safety information fully.
- **Distraction Hazard:** Any navigation features may require manual (non-verbal) setup. Attempting to perform such set-up or insert data while driving can distract your attention and could cause an accident or other serious injury. Stop the vehicle in a safe and legal manner before attempting these operations.
- **Let Your Judgment Prevail:** Any navigation features are provided only as an aid. Make your driving decisions based on your observations of local conditions and existing traffic regulations. Any such feature is not a substitute for your personal judgment. Any route suggestions made by this system should never replace any local traffic regulations or your personal judgment or knowledge of safe driving practices.
- **Route Safety:** Do not follow the route suggestions if doing so would result in an unsafe or illegal maneuver, if you would be placed in an unsafe situation, or if you would be directed into an area that you consider unsafe. The driver is ultimately responsible for the safe operation of the vehicle and therefore, must evaluate whether it is safe to follow the suggested directions.
- **Potential Map Inaccuracy:** Maps used by this system may be inaccurate because of changes in roads, traffic controls or driving conditions. Always use good judgment and common sense when following the suggested routes.
- **Emergency Services:** Do not rely on any navigation features included in the system to route you to emergency services. Ask local authorities or an emergency services operator for these locations. Not all emergency services such as police, fire stations, hospitals and clinics are likely to be contained in the map database for such navigation features.

# Appendices

---

## Your Responsibilities and Assumptions of Risk

- You agree to each of the following: (a) Any use of the SOFTWARE while driving an automobile or other vehicle in violation of applicable law or otherwise driving in an unsafe manner presents a significant risk of distracted driving and should not be attempted under any circumstances; (b) Use of the SOFTWARE at excessive volume poses a significant risk of hearing damage and should not be attempted under any circumstances; (c) The SOFTWARE may not be compatible with new or different versions of an operating system, third party software, or third party services, and the SOFTWARE may potentially cause a critical failure of an operating system, third party software, or third party service. (d) Any third party service accessed by or third party software used with the SOFTWARE (i) may charge an additional fee for access, (ii) may not work correctly, on an uninterrupted basis, or error free, (iii) may change streaming formats or discontinue operation, (iv) may contain adult, profane or offensive content; and (v) may contain inaccurate, false or misleading traffic, weather, financial or safety information or other content; and (e) Use of the SOFTWARE may cause you to incur additional charges from your wireless service provider (WSP) and any data or minute calculators that may be included in the software program are for reference only, are not warranted in any way and should not be relied upon in anyway.
- When using the SOFTWARE, you agree to be responsible for and assume the entire risk to the items set forth in Section (a) – (e) above.

## Disclaimer of Warranty

YOU EXPRESSLY ACKNOWLEDGE AND AGREE THAT USE OF THE DEVICES AND SOFTWARE IS AT YOUR SOLE RISK AND THAT THE ENTIRE RISK AS TO SATISFACTORY QUALITY, PERFORMANCE, COMPATIBILITY, ACCURACY AND EFFORT IS WITH YOU. TO THE MAXIMUM EXTENT PERMITTED BY APPLICABLE LAW, THE SOFTWARE AND ANY THIRD PARTY SOFTWARE OR THIRD-PARTY SERVICES ARE PROVIDED "AS IS" AND "AS AVAILABLE", WITH ALL FAULTS AND WITHOUT WARRANTY OF ANY KIND, AND FORD MOTOR COMPANY HEREBY DISCLAIMS ALL WARRANTIES AND CONDITIONS WITH RESPECT TO THE SOFTWARE, THIRD PARTY SOFTWARE, AND THIRD-PARTY SERVICES, EITHER EXPRESS, IMPLIED OR STATUTORY, INCLUDING, BUT NOT LIMITED TO, THE IMPLIED WARRANTIES AND/OR CONDITIONS OF MERCHANTABILITY, OF SATISFACTORY QUALITY, OF FITNESS FOR AN PARTICULAR PURPOSE, OF ACCURACY, OF QUIET ENJOYMENT, AND NON-INFRINGEMENT OF THIRD-PARTY RIGHTS. FORD MOTOR COMPANY DOES NOT WARRANT (a) AGAINST INTERFERENCE WITH YOUR ENJOYMENT OF THE SOFTWARE, THIRD PARTY SOFTWARE, OR THIRD-PARTY SERVICES, (b) THAT THE SOFTWARE, THIRD PARTY SOFTWARE, OR THIRD-PARTY SERVICES WILL MEET YOUR REQUIREMENTS, (c) THAT THE OPERATION OF THE SOFTWARE, THIRD PARTY SOFTWARE, OR THIRD-PARTY SERVICES WILL BE UNINTERRUPTED OR ERROR-FREE, (d) OR THAT DEFECTS IN THE SOFTWARE, THIRD PARTY SOFTWARE, OR THIRD-PARTY SERVICES WILL BE CORRECTED. NO ORAL OR WRITTEN INFORMATION OR ADVICE GIVEN BY FORD MOTOR COMPANY OR ITS AUTHORIZED REPRESENTATIVE SHALL

# Appendices

CREATE A WARRANTY. SHOULD THE SOFTWARE, THIRD PARTY SOFTWARE, OR THIRD-PARTY SERVICES PROVE DEFECTIVE, YOU ASSUME THE ENTIRE COST OF ALL NECESSARY SERVICING, REPAIR OR CORRECTION. SOME JURISDICTIONS DO NOT ALLOW THE DISCLAIMER OF IMPLIED WARRANTIES OR LIMITATIONS ON APPLICABLE STATUTORY RIGHTS OF A CONSUMER, SO THE ABOVE DISCLAIMER MAY NOT FULLY APPLY TO YOU. THE SOLE WARRANTY PROVIDED BY FORD MOTOR COMPANY SHALL BE FOUND IN THE WARRANTY INFORMATION INCLUDING WITH YOUR OWNER GUIDE. TO THE EXTENT THAT THERE IS ANY CONFLICT BETWEEN THE TERMS OF THIS SECTION AND THE WARRANTY BOOKLET, THE WARRANTY BOOKLET SHALL CONTROL.

## Applicable Law, Venue, Jurisdiction

- The laws of the State of Michigan govern this EULA and Your use of the SOFTWARE. Your use of the SOFTWARE may also be subject to other local, state, national, or international laws. Any litigation arising out of or related to this EULA shall be brought and maintained exclusively in a court of the State of Michigan located in Wayne County or in the United States District Court for the Eastern District of Michigan. You hereby consent to submit to the personal jurisdiction of a court in the State of Michigan located in Wayne County and the United States District Court for the Eastern District of Michigan for any dispute arising out of or relating to this EULA.

## Binding Arbitration and Class Action Waiver

**(a) Application.** This Section applies to any dispute EXCEPT IT DOES NOT INCLUDE A DISPUTE RELATING TO COPYRIGHT INFRINGEMENT, OR TO THE ENFORCEMENT OR VALIDITY OF YOUR, FORD MOTOR COMPANY, OR ANY OF FORD MOTOR COMPANY'S LICENSORS' INTELLECTUAL PROPERTY RIGHTS.

Dispute means any dispute, action, or other controversy between You and FORD MOTOR COMPANY, other than the exceptions listed above, concerning the SOFTWARE (including its price) or this EULA, whether in contract, warranty, tort, statute, regulation, ordinance, or any other legal or equitable basis.

**(b) Notice of Dispute.** In the event of a Dispute, You or FORD MOTOR COMPANY must give the other a "Notice of Dispute", which is a written statement of the name, address, and contact information of the party giving it, the facts giving rise to the dispute, and the relief requested. You and FORD MOTOR COMPANY will attempt to resolve any dispute through informal negotiation within 60 days from the date the Notice of Dispute is sent. After 60 days, You or FORD MOTOR COMPANY may commence arbitration.

**(c) Small claims court.** You may also litigate any dispute in small claims court in your county of residence or FORD MOTOR COMPANY'S principal place of business, if the dispute meets all requirements to be heard in the small claims court. You may litigate in small claims court whether or not You negotiated informally first.

**(d) Binding arbitration.** If You and FORD MOTOR COMPANY, do not resolve any dispute by informal negotiation or in small claims court, any other effort to resolve the dispute will be conducted exclusively by binding arbitration. You are giving up

## Appendices

---

the right to litigate (or participate in as a party or class member) all disputes in court before a judge or jury. Instead, all disputes will be resolved before a neutral arbitrator, whose decision will be final except for a limited right of appeal under the Federal Arbitration Act. Any court with jurisdiction over the parties may enforce the arbitrator's award.

**(e) Class action waiver.** Any proceedings to resolve or litigate any dispute in any forum will be conducted solely on an individual basis. Neither you nor FORD MOTOR COMPANY, will seek to have any dispute heard as a class action, as a private attorney general action, or in any other proceeding in which any party acts or proposes to act in a representative capacity. No arbitration or proceeding will be combined with another without the prior written consent of all parties to all affected arbitrations or proceedings.

**(f) Arbitration procedure.** Any arbitration will be conducted by the American Arbitration Association (the "AAA"), under its Commercial Arbitration Rules. If You are an individual and use the SOFTWARE for personal or vehicle use, or if the value of the dispute is \$75,000 or less whether or not You are an individual or how You use the SOFTWARE, the AAA Supplementary Procedures for Consumer-Related Disputes will also apply. To commence arbitration, submit a Commercial Arbitration Rules Demand for Arbitration form to the AAA. You may request a telephonic or in-person hearing by following the AAA rules. In a dispute involving \$10,000 or less, any hearing will be telephonic unless the arbitrator finds good cause to hold an in-person hearing instead. For more information, see [adr.org](http://adr.org) or call 1-800-778-7879. You agree to commence arbitration only in your county of residence or FORD MOTOR COMPANY'S principal place of business. The arbitrator

may award the same damages to You individually as a court could. The arbitrator may award declaratory or injunctive relief only to You individually, and only to the extent required to satisfy Your individual claim.

### **(g) Arbitration fees and incentives.**

- I. Disputes involving \$75,000 or less. FORD MOTOR COMPANY will promptly reimburse your filing fees and pay the AAA's and arbitrator's fees and expenses. If you reject FORD MOTOR COMPANY'S last written settlement offer made before the arbitrator was appointed ("last written offer"), your dispute goes all the way to an arbitrator's decision (called an "award"), and the arbitrator awards you more than the last written offer, FORD MOTOR COMPANY will give you three incentives: (1) pay the greater of the award or \$1,000; (2) pay twice your reasonable attorney's fees, if any; and (3) reimburse any expenses (including expert witness fees and costs) that your attorney reasonably accrues for investigating, preparing, and pursuing your claim in arbitration. The arbitrator will determine the amounts.
- ii. Disputes involving more than \$75,000. The AAA rules will govern payment of filing fees and the AAA's and arbitrator's fees and expenses.
- iii. Disputes involving any amount. In any arbitration you commence, FORD MOTOR COMPANY will seek its AAA or arbitrator's fees and expenses, or Your filing fees it reimbursed, only if the arbitrator finds the arbitration frivolous or brought for an improper purpose. In any arbitration FORD MOTOR COMPANY commences, it will pay all

# Appendices

---

filing, AAA, and arbitrator's fees and expenses. It will not seek its attorney's fees or expenses from you in any arbitration. Fees and expenses are not counted in determining how much a dispute involves.

**(h) Claims or disputes must be filed within one year.** To the extent permitted by law, any claim or dispute under this EULA to which this Section applies must be filed within one year in small claims court (Section c) or in arbitration (Section d). The one-year period begins when the claim or dispute first could be filed. If such a claim or dispute is not filed within one year, it is permanently barred.

**(i) Severability.** If the class action waiver (Section e) is found to be illegal or unenforceable as to all or some parts of a dispute, then that portion of Section e will not apply to those parts. Instead, those parts will be severed and proceed in a court of law, with the remaining parts proceeding in arbitration. If any other provision of that portion Section e is found to be illegal or unenforceable, that provision will be severed with the remainder of Section e remaining in full force and effect.

## **Telenav Software End User License Agreement**

Please read these terms and conditions carefully before you use the TeleNav Software. Your use of the TeleNav Software indicates that you accept these terms and conditions. If you do not accept these terms and conditions, do not break the seal of the package, launch, or otherwise use the TeleNav Software. TeleNav may revise this Agreement and the privacy policy at any time, with or without notice to you. You agree to visit <http://www.telenav.com> from time to time to review the then current version of this Agreement and of the privacy policy.

## **1. Safe and Lawful Use**

You acknowledge that devoting attention to the TeleNav Software may pose a risk of injury or death to you and others in situations that otherwise require your undivided attention, and you therefore agree to comply with the following when using the TeleNav Software:

- (a) observe all traffic laws and otherwise drive safely;
- (b) use your own personal judgment while driving. If you feel that a route suggested by the TeleNav Software instructs you to perform an unsafe or illegal maneuver, places you in an unsafe situation, or directs you into an area that you consider to be unsafe, do not follow such instructions;
- (c) do not input destinations, or otherwise manipulate the TeleNav Software, unless your vehicle is stationary and parked;
- (d) do not use the TeleNav Software for any illegal, unauthorized, unintended, unsafe, hazardous, or unlawful purposes, or in any manner inconsistent with this Agreement;
- (e) arrange all GPS and wireless devices and cables necessary for use of the TeleNav Software in a secure manner in your vehicle so that they will not interfere with your driving and will not prevent the operation of any safety device (such as an airbag).

You agree to indemnify and hold TeleNav harmless against all claims resulting from any dangerous or otherwise inappropriate use of the TeleNav Software in any moving vehicle, including as a result of your failure to comply with the directions above.

# Appendices

---

## 2. Account Information

You agree: (a) when registering the TeleNav Software, to provide TeleNav with true, accurate, current, and complete information about yourself, and (b) to inform TeleNav promptly of any changes to such information, and to keep it true, accurate, current and complete.

## 3. Software License

- Subject to your compliance with the terms of this Agreement, TeleNav hereby grants to you a personal, non-exclusive, non-transferable license (except as expressly permitted below in connection with your permanent transfer of the TeleNav Software license), without the right to sublicense, to use the TeleNav Software (in object code form only) in order to access and use the TeleNav Software. This license shall terminate upon any termination or expiration of this Agreement. You agree that you will use the TeleNav Software only for your personal business or leisure purposes, and not to provide commercial navigation services to other parties.

### 3.1 License Limitations

- **(a)** reverse engineer, decompile, disassemble, translate, modify, alter or otherwise change the TeleNav Software or any part thereof; **(b)** attempt to derive the source code, audio library or structure of the TeleNav Software without the prior express written consent of TeleNav; **(c)** remove from the TeleNav Software, or alter, any of TeleNav's or its suppliers' trademarks, trade names, logos, patent or copyright notices, or other notices or markings; **(d)**

distribute, sublicense or otherwise transfer the TeleNav Software to others, except as part of your permanent transfer of the TeleNav Software; or **(e)** use the TeleNav Software in any manner that

- i. infringes the intellectual property or proprietary rights, rights of publicity or privacy or other rights of any party,
- ii. violates any law, statute, ordinance or regulation, including but not limited to laws and regulations related to spamming, privacy, consumer and child protection, obscenity or defamation, or
- iii. is harmful, threatening, abusive, harassing, tortuous, defamatory, vulgar, obscene, libelous, or otherwise objectionable; and (f) lease, rent out, or otherwise permit unauthorized access by third parties to the TeleNav Software without advanced written permission of TeleNav.

## 4. Disclaimers

- To the fullest extent permissible pursuant to applicable law, in no event will TeleNav, its licensors and suppliers, or agents or employees of any of the foregoing, be liable for any decision made or action taken by you or anyone else in reliance on the information provided by the TeleNav Software. TeleNav also does not warrant the accuracy of the map or other data used for the TeleNav Software. Such data may not always reflect reality due to, among other things, road closures, construction, weather, new roads and other changing conditions. You are responsible for the entire risk arising out of your use of the TeleNav Software. For example but without limitation, you agree not to rely on the TeleNav Software for critical navigation in areas where the well-being or survival of you or others

# Appendices

---

is dependent on the accuracy of navigation, as the maps or functionality of the TeleNav Software are not intended to support such high risk applications, especially in more remote geographical areas.

- TELENAV EXPRESSLY DISCLAIMS AND EXCLUDES ALL WARRANTIES IN CONNECTION WITH THE TELENAV SOFTWARE, WHETHER STATUTORY, EXPRESS OR IMPLIED, INCLUDING ALL WARRANTIES WHICH MAY ARISE FROM COURSE OF DEALING, CUSTOM OR TRADE AND INCLUDING, BUT NOT LIMITED TO, THE IMPLIED WARRANTIES OF MERCHANTABILITY, FITNESS FOR A PARTICULAR PURPOSE AND NON-INFRINGEMENT OF THIRD PARTY RIGHTS WITH RESPECT TO THE TELENAV SOFTWARE.
- Certain jurisdictions do not permit the disclaimer of certain warranties, so this limitation may not apply to you.

## **5. Limitation of Liability**

- TO THE EXTENT PERMITTED UNDER APPLICABLE LAW, UNDER NO CIRCUMSTANCES SHALL TELENAV OR ITS LICENSORS AND SUPPLIERS BE LIABLE TO YOU OR TO ANY THIRD PARTY FOR ANY INDIRECT, INCIDENTAL, CONSEQUENTIAL, SPECIAL OR EXEMPLARY DAMAGES (INCLUDING IN EACH CASE, BUT NOT LIMITED TO, DAMAGES FOR THE INABILITY TO USE THE EQUIPMENT OR ACCESS DATA, LOSS OF DATA, LOSS OF BUSINESS, LOSS OF PROFITS, BUSINESS INTERRUPTION OR THE LIKE) ARISING OUT OF THE USE OF OR INABILITY TO USE THE TELENAV SOFTWARE, EVEN IF TELENAV HAS BEEN ADVISED OF THE POSSIBILITY OF SUCH DAMAGES. NOTWITHSTANDING ANY DAMAGES THAT YOU MIGHT INCUR FOR ANY

REASON WHATSOEVER (INCLUDING, WITHOUT LIMITATION, ALL DAMAGES REFERENCED HEREIN AND ALL DIRECT OR GENERAL DAMAGES IN CONTRACT, TORT (INCLUDING NEGLIGENCE) OR OTHERWISE), THE ENTIRE LIABILITY OF TELENAV AND OF ALL OF TELENAV'S SUPPLIERS SHALL BE LIMITED TO THE AMOUNT ACTUALLY PAID BY YOU FOR THE TELENAV SOFTWARE. SOME STATES AND/OR JURISDICTIONS DO NOT ALLOW THE EXCLUSION OR LIMITATION OF INCIDENTAL OR CONSEQUENTIAL DAMAGES, SO THE ABOVE LIMITATIONS OR EXCLUSIONS MAY NOT APPLY TO YOU.

## **6. Arbitration and Governing Law**

- You agree that any dispute, claim or controversy arising out of or relating to this Agreement or the TeleNav Software shall be settled by independent arbitration involving a neutral arbitrator and administered by the American Arbitration Association in the County of Santa Clara, California. The arbitrator shall apply the Commercial Arbitration Rules of the American Arbitration Association, and the judgment upon the award rendered by the arbitrator may be entered by any court having jurisdiction. Note that there is no judge or jury in an arbitration proceeding and the decision of the arbitrator shall be binding upon both parties. You expressly agree to waive your right to a jury trial. This Agreement and performance hereunder will be governed by and construed in accordance with the laws of the State of California, without giving effect to its conflict of law provisions. To the extent judicial action is necessary in connection with the binding arbitration, both TeleNav and you agree to submit



# Appendices

---

to the exclusive jurisdiction of the courts of the County of Santa Clara, California. The United Nations Convention on Contracts for the International Sale of Goods shall not apply.

## **7. Assignment**

- You may not resell, assign, or transfer this Agreement or any of your rights or obligations, except in totality, in connection with your permanent transfer of the TeleNav Software, and expressly conditioned upon the new user of the TeleNav Software agreeing to be bound by the terms and conditions of this Agreement. Any such sale, assignment or transfer that is not expressly permitted under this paragraph will result in immediate termination of this Agreement, without liability to TeleNav, in which case you and all other parties shall immediately cease all use of the TeleNav Software. Notwithstanding the foregoing, TeleNav may assign this Agreement to any other party at any time without notice, provided the assignee remains bound by this Agreement.

## **8. Miscellaneous**

### **8.1**

This Agreement constitutes the entire agreement between TeleNav and you with respect to the subject matter hereof.

### **8.2**

Except for the limited licenses expressly granted in this Agreement, TeleNav retains all right, title and interest in and to the TeleNav Software, including without limitation all related intellectual property rights. No licenses or other rights which are not expressly granted in this Agreement are intended to, or shall be, granted or

conferred by implication, statute, inducement, estoppel or otherwise, and TeleNav and its suppliers and licensors hereby reserve all of their respective rights other than the licenses explicitly granted in this Agreement.

### **8.3**

By using the TeleNav Software, you consent to receive from TeleNav all communications, including notices, agreements, legally required disclosures or other information in connection with the TeleNav Software (collectively, "Notices") electronically. TeleNav may provide such Notices by posting them on TeleNav's Website or by downloading such Notices to your wireless device. If you desire to withdraw your consent to receive Notices electronically, you must discontinue your use of the TeleNav Software.

### **8.4**

TeleNav's or your failure to require performance of any provision shall not affect that party's right to require performance at any time thereafter, nor shall a waiver of any breach or default of this Agreement constitute a waiver of any subsequent breach or default or a waiver of the provision itself.

### **8.5**

If any provision herein is held unenforceable, then such provision will be modified to reflect the intention of the parties, and the remaining provisions of this Agreement will remain in full force and effect.

# Appendices

## 8.6

The headings in this Agreement are for convenience of reference only, will not be deemed to be a part of this Agreement, and will not be referred to in connection with the construction or interpretation of this Agreement. As used in this Agreement, the words "include" and "including" and variations thereof, will not be deemed to be terms of limitation, but rather will be deemed to be followed by the words "without limitation".

## 9. Other Vendors Terms and Conditions

- The Telenav Software utilizes map and other data licensed to Telenav by third party vendors for the benefit of you and other end users. This Agreement includes end-user terms applicable to these companies (included at the end of this Agreement), and thus your use of the Telenav Software is also subject to such terms. You agree to comply with the following additional terms and conditions, which are applicable to Telenav's third party vendor licensors::

### 9.1 End User Terms Required by HERE North America, LLC

The data ("Data") is provided for your personal, internal use only and not for resale. It is protected by copyright, and is subject to the following terms and conditions which are agreed to by you, on the one hand, and Telenav ("Telenav") and its licensors (including their licensors and suppliers) on the other hand.

© 2013 HERE. All rights reserved.

The Data for areas of Canada includes information taken with permission from Canadian authorities, including: © Her Majesty the Queen in Right of Canada, © Queen's Printer for Ontario, © Canada Post Corporation, GeoBase®, © Department of Natural Resources Canada.

HERE holds a non-exclusive license from the United States Postal Service® to publish and sell ZIP+4® information.

©United States Postal Service® 2014. Prices are not established, controlled or approved by the United States Postal Service®. The following trademarks and registrations are owned by the USPS: United States Postal Service, USPS, and ZIP+4

The Data for Mexico includes certain data from Instituto Nacional de Estadística y Geografía.

### 9.2 End User Terms Required by NAV2 (Shanghai) Co., Ltd

The data ("Data") is provided for your personal, internal use only and not for resale. It is protected by copyright, and is subject to the following terms and conditions which are agreed to by you, on the one hand, and NAV2 (Shanghai) Co., Ltd ("NAV2") and its licensors (including their licensors and suppliers) on the other hand. 20xx. All rights reserved

#### Terms and Conditions

**Permitted Use.** You agree to use this Data together with the Telenav Software solely for the internal business and personal purposes for which you were licensed, and not for service bureau, time-sharing or other similar purposes. Accordingly, but subject to the restrictions set forth in the following paragraphs, you agree not to otherwise reproduce, copy, modify, decompile, disassemble, create any derivative works of, or reverse engineer any portion of this Data, and may not transfer or distribute it in any form, for any purpose, except to the extent permitted by mandatory laws.

# Appendices

---

**Restrictions.** Except where you have been specifically licensed to do so by Telenav, and without limiting the preceding paragraph, you may not use this Data (a) with any products, systems, or applications installed or otherwise connected to or in communication with vehicles, capable of vehicle navigation, positioning, dispatch, real time route guidance, fleet management or similar applications; or (b) with or in communication with any positioning devices or any mobile or wireless-connected electronic or computer devices, including without limitation cellular phones, palmtop and handheld computers, pagers, and personal digital assistants or PDAs.

**Warning.** The Data may contain inaccurate or incomplete information due to the passage of time, changing circumstances, sources used and the nature of collecting comprehensive geographic data, any of which may lead to incorrect results.

**No Warranty.** This Data is provided to you “as is,” and you agree to use it at your own risk. Telenav and its licensors (and their licensors and suppliers) make no guarantees, representations or warranties of any kind, express or implied, arising by law or otherwise, including but not limited to, content, quality, accuracy, completeness, effectiveness, reliability, fitness for a particular purpose, usefulness, use or results to be obtained from this Data, or that the Data or server will be uninterrupted or error-free.

**Disclaimer of Warranty:** TELENAV AND ITS LICENSORS (INCLUDING THEIR LICENSORS AND SUPPLIERS) DISCLAIM ANY WARRANTIES, EXPRESS OR IMPLIED, OF QUALITY, PERFORMANCE, MERCHANTABILITY, FITNESS FOR A

PARTICULAR PURPOSE OR NON-INFRINGEMENT. Some States, Territories and Countries do not allow certain warranty exclusions, so to that extent the above exclusion may not apply to you.

**Disclaimer of Liability:** TELENAV AND ITS LICENSORS (INCLUDING THEIR LICENSORS AND SUPPLIERS) SHALL NOT BE LIABLE TO YOU: IN RESPECT OF ANY CLAIM, DEMAND OR ACTION, IRRESPECTIVE OF THE NATURE OF THE CAUSE OF THE CLAIM, DEMAND OR ACTION ALLEGING ANY LOSS, INJURY OR DAMAGES, DIRECT OR INDIRECT, WHICH MAY RESULT FROM THE USE OR POSSESSION OF THE INFORMATION; OR FOR ANY LOSS OF PROFIT, REVENUE, CONTRACTS OR SAVINGS, OR ANY OTHER DIRECT, INDIRECT, INCIDENTAL, SPECIAL OR CONSEQUENTIAL DAMAGES ARISING OUT OF YOUR USE OF OR INABILITY TO USE THIS INFORMATION, ANY DEFECT IN THE INFORMATION, OR THE BREACH OF THESE TERMS OR CONDITIONS, WHETHER IN AN ACTION IN CONTRACT OR TORT OR BASED ON A WARRANTY, EVEN IF TELENAV OR ITS LICENSORS HAVE BEEN ADVISED OF THE POSSIBILITY OF SUCH DAMAGES. Some States, Territories and Countries do not allow certain liability exclusions or damages limitations, so to that extent the above may not apply to you.

**Export Control.** You shall not export from anywhere any part of the Data or any direct product thereof except in compliance with, and with all licenses and approvals required under, applicable export laws, rules and regulations, including but not limited to the laws, rules and regulations administered by the Office of Foreign Assets Control of the U.S. Department of Commerce and the Bureau of Industry and Security of the U.S. Department of Commerce. To the extent that any such

# Appendices

export laws, rules or regulations prohibit HERE from complying with any of its obligations hereunder to deliver or distribute Data, such failure shall be excused and shall not constitute a breach of this Agreement.

**Entire Agreement.** These terms and conditions constitute the entire agreement between Telenav (and its licensors, including their licensors and suppliers) and you pertaining to the subject matter hereof, and supersedes in their entirety any and all written or oral agreements previously existing between us with respect to such subject matter.

**Governing Law.** The above terms and conditions shall be governed by the laws of the State of Illinois [insert "Netherlands" where European HERE Data is used], without giving effect to (i) its conflict of laws provisions, or (ii) the United Nations Convention for Contracts for the International Sale of Goods, which is explicitly excluded. You agree to submit to the jurisdiction of the State of Illinois [insert "The Netherlands" where European HERE Data is used] for any and all disputes, claims and actions arising from or in connection with the Data provided to you hereunder.

**Government End Users.** If the Data is being acquired by or on behalf of the United States government or any other entity seeking or applying rights similar to those customarily claimed by the United States government, this Data is a "commercial item" as that term is defined at 48 C.F.R. ("FAR") 2.101, is licensed in accordance with these End-User Terms, and each copy of Data delivered or otherwise furnished shall be marked and embedded as appropriate with the following "Notice of Use," and shall be treated in accordance with such Notice:

NOTICE OF USE
CONTRACTOR (MANUFACTURER/ SUPPLIER) NAME: HERE
CONTRACTOR (MANUFACTURER/ SUPPLIER) ADDRESS: c/o Nokia, 425 West Randolph Street, Chicago, Illinois 60606
This Data is a commercial item as defined in FAR 2.101 and is subject to these End-User Terms under which this Data was provided.
© 1987 – 2014 HERE – All rights reserved.

If the Contracting Officer, federal government agency, or any federal official refuses to use the legend provided herein, the Contracting Officer, federal government agency, or any federal official must notify HERE prior to seeking additional or alternative rights in the Data.

## I. US/Canada Territory

A. United States Data. The End-User Terms for any Application containing Data for the United States shall contain the following notices:

"HERE holds a non-exclusive license from the United States Postal Service® to publish and sell ZIP+4® information."

"©United States Postal Service® 20XX. Prices are not established, controlled or approved by the United States Postal Service®. The following trademarks and registrations are owned by the USPS: United States Postal Service, USPS, and ZIP+4."

## Appendices

---

B. Canada Data. The following provisions apply to the Data for Canada, which may include or reflect data from third party licensors (“Third Party Data”), including Her Majesty the Queen in Right of Canada (“Her Majesty”), Canada Post Corporation (“Canada Post”) and the Department of Natural Resources of Canada (“NRCan”):

1. Disclaimer and Limitation: Client agrees that its use of the Third Party Data is subject to the following provisions:

a. Disclaimer: The Third Party Data is licensed on an “as is” basis. The licensors of such data, including Her Majesty, Canada Post and NRCan, make no guarantees, representations or warranties respecting such data, either express or implied, arising by law or otherwise, including but not limited to, effectiveness, completeness, accuracy or fitness for a particular purpose.

b. Limitation on Liability: The Third Party Data licensors, including Her Majesty, Canada Post and NRCan, shall not be liable: (i) in respect of any claim, demand or action, irrespective of the nature of the cause of the claim, demand or action alleging any loss, injury or damages, direct or indirect, which may result from the use or possession of such Data; or (ii) in any way for loss of revenues or contracts, or any other consequential loss of any kind resulting from any defect in the Data.

2. Copyright Notice: In connection with each copy of all or any portion of the Data for the Territory of Canada, Client shall affix in a conspicuous manner the following copyright notice on at least one of: (i) the label for the storage media of the copy; (ii) the packaging for the copy; or (iii) other materials packaged with the copy, such as user manuals or end user license agreements: “This data includes information taken with permission from Canadian authorities, including © Her Majesty the Queen in Right of Canada, © Queen’s Printer for Ontario, © Canada Post Corporation, GeoBase®, © The Department of Natural Resources Canada. All rights reserved.”

3. End-User Terms: Except as otherwise agreed by the parties, in connection with the provision of any portion of the Data for the Territory of Canada to End-Users as may be authorized under the Agreement, Client shall provide such End-Users, in a reasonably conspicuous manner, with terms (set forth with other end user terms required to be provided under the Agreement, or as otherwise may be provided, by Client) which shall include the following provisions on behalf of the Third Party Data licensors, including Her Majesty, Canada Post and NRCan:

The Data may include or reflect data of licensors, including Her Majesty the Queen in the Right of Canada (“Her Majesty”), Canada Post Corporation (“Canada Post”) and the Department of Natural Resources Canada (“NRCan”). Such data is licensed on an “as is” basis. The licensors, including Her Majesty, Canada Post and NRCan, make no guarantees, representations or warranties respecting such data,

# Appendices

---

either express or implied, arising by law or otherwise, including but not limited to, effectiveness, completeness, accuracy or fitness for a particular purpose. The licensors, including Her Majesty, Canada Post and NRCan, shall not be liable in respect of any claim, demand or action, irrespective of the nature of the cause of the claim, demand or action alleging any loss, injury or damages, direct or indirect, which may result from the use or possession of the data or the Data. The licensors, including Her Majesty, Canada Post and NRCan, shall not be liable in any way for loss of revenues or contracts, or any other consequential loss of any kind resulting from any defect in the data or the Data.

End User shall indemnify and save harmless the licensors, including Her Majesty, Canada Post and NRCan, and their officers, employees and agents from and against any claim, demand or action, irrespective of the nature of the cause of the claim, demand or action, alleging loss, costs, expenses, damages or injuries (including injuries resulting in death) arising out of the use or possession of the data or the Data.

4. Additional Provisions: The terms contained in this Section are in addition to all of the rights and obligations of the parties under the Agreement. To the extent that any of the provisions of this Section are inconsistent with, or conflict with, any other provisions of the Agreement, the provisions of this Section shall prevail.

II. Mexico. The following provision applies to the Data for Mexico, which includes certain data from the Instituto Nacional de Estadística y Geografía (“INEGI”):

A. Any and all copies of the Data and/or packaging containing Data for Mexico shall contain the following notice: “Fuente: INEGI (Instituto Nacional de Estadística y Geografía)”

III. Latin America Territory

A. Third Party Notices. Any and all copies of the Data and/or packaging relating thereto shall include the respective Third Party Notices set forth below and used as described below corresponding to the Territory (or portion thereof) included in such copy:

Territory Notice

Ecuador “INSTITUTO GEOGRAFICO MILITAR DEL ECUADOR AUTORIZACION N° IGM-2011-01- PCO-01 DEL 25 DE ENERO DE 2011”  
“source: © IGN 2009 - BD TOPO ®”

Guadeloupe,  
French  
Guiana  
and

Martinique “Fuente: INEGI (Instituto Nacional de Estadística y Geografía)”  
Mexico

IV. Middle East Territory

# Appendices

---

A. Third Party Notices. Any and all copies of the Data and/or packaging relating thereto shall include the respective Third Party Notices set forth below and used as described below corresponding to the Territory (or portion thereof) included in such copy:

Country Notice

Jordan “© Royal Jordanian Geographic Centre”. The foregoing notice requirement for Jordan Data is a material term of the Agreement. If Client or any of its permitted sublicensees (if any) fail to meet such requirement, HERE shall have the right to terminate Client’s license with respect to the Jordan Data.

B. Jordan Data. Client and its permitted sublicensees (if any) are restricted from licensing and/or otherwise distributing HERE’s database for the country of Jordan (“Jordan Data”) for use in Enterprise Applications to (i) non-Jordanian entities for use of the Jordan Data solely in Jordan or (ii) Jordan-based customers. In addition, Client, its permitted sublicensees (if any) and End-Users are restricted from using the Jordan Data in Enterprise Applications if such party is (i) a non-Jordanian entity using the Jordan Data solely in Jordan or (ii) a Jordan-based customer. For purposes of the foregoing, “Enterprise Applications” shall mean Geomarketing applications, GIS applications, mobile business asset management applications, call center applications, telematics applications, public organization Internet applications or for providing geocoding services.

## V. Europe Territory

### A. Use of Certain Traffic Codes in Europe

1. General Restrictions Applicable to Traffic Codes. Client acknowledges and agrees that in certain countries of the Europe Territory, Client will need to obtain rights directly from third party RDS-TMC code providers to receive and use the Traffic Codes in the Data and to deliver to End-Users Transactions in any way derived from or based on such Traffic Codes. For such countries, HERE shall deliver the Data incorporating Traffic Codes to Client only after receiving certification from Client of its having obtained such rights.

2. Display of Third Party Rights Legends for Belgium. Client shall, for each Transaction that uses Traffic Codes for Belgium, provide the following notice to the End-User: “Traffic Codes for Belgium are provided by the Ministerie van de Vlaamse Gemeenschap and the Ministère de l’Equipeement et des Transports.”

B. Paper Maps. With respect to any license granted to Client relating to making, selling or distributing paper maps (i.e., a map fixed on a paper or paper-like medium): (a) such license with respect to Data for the Territory of Great Britain is conditioned on Client’s entering into and complying with a separate written agreement with the Ordnance Survey (“OS”) to create and sell paper maps, Client’s paying to the OS any and all applicable paper map royalties, and Client’s complying with the OS copyright notice requirements; (b) such license for selling or otherwise distributing for charge with respect to Data for the Territory of Czech Republic

# Appendices

is conditioned on Client's obtaining prior written consent from Kartografie a.s.; (c) such license for selling or distributing with respect to Data for the Territory of Switzerland is conditioned on Client's obtaining a permit from Bundesamt für Landestopografie of Switzerland; (d) Client is restricted from using Data for the Territory of France to create paper maps with a scale between 1:5,000 and 1:250,000; and (e) Client is restricted from using any Data to create, sell or distribute paper maps that are the same or substantially similar, in terms of data content and specific use of color, symbols and scale, to paper maps published by the European national mapping agencies, including without limitation, Landervermessungämter of Germany, Topografische Dienst of the Netherlands, Nationaal Geografisch Instituut of Belgium, Bundesamt für Landestopografie of Switzerland, Bundesamt für Eich-und Vermessungswesen of Austria, and the National Land Survey of Sweden.

C. OS Enforcement. Without limiting Section IV(B) above, with respect to Data for the Territory of Great Britain, Client acknowledges and agrees that the Ordnance Survey ("OS") may bring a direct action against Client to enforce compliance with the OS copyright notice (see Section IV(D) below) and paper map requirements (see Section IV(B) above) contained in this Agreement.

D. Third Party Notices. Any and all copies of the Data and/or packaging relating thereto shall include the respective Third Party Notices set forth below and used as described below corresponding to the Territory (or portion thereof) included in such copy:

Country(ies) Notice

Austria	"© Bundesamt für Eich- und Vermessungswesen"
Croatia Cyprus, Estonia, Latvia, Lithuania, Moldova, Poland, Slovenia and/or Ukraine	"© EuroGeographics"
France	"source: © IGN 2009 – BD TOPO ®"
Germany	"Die Grundlagendaten wurden mit Genehmigung der zuständigen Behörden entnommen"
Great Britain	"Contains Ordnance Survey data © Crown copyright and database right 2010 Contains Royal Mail data © Royal Mail copyright and database right 2010"
Greece	"Copyright Geomatics Ltd."
Hungary	"Copyright © 2003; Top-Map Ltd."
Italy	"La Banca Dati Italiana è stata prodotta usando quale riferimento anche cartografia numerica ed al tratto prodotta e fornita dalla Regione Toscana."
Norway	"Copyright © 2000; Norwegian Mapping Authority"
Portugal	"Source: IgeoE – Portugal"



# Appendices

Spain “Información geográfica propiedad del CNIG”

Sweden “Based upon electronic data © National Land Survey Sweden.”

Switzerland “Topografische Grundlage: © Bundesamt für Landestopographie.

E. Respective Country Distribution. Client acknowledges that HERE has not received approvals to distribute map data for the following countries in such respective countries: Albania, Belarus, Kyrgyzstan, Moldova and Uzbekistan. HERE may update such list from time to time. The license rights granted to Client under this TL with respect to the Data for such countries are contingent upon Client’s compliance with all applicable laws and regulations, including, without limitation, any required licenses or approvals to distribute the Application incorporating such Data in such respective countries.

## VI. Australia Territory

A. Third Party Notices. Any and all copies of the Data and/or packaging relating thereto shall include the respective Third Party Notices set forth below and used as described below corresponding to the Territory (or portion thereof) included in such copy:

Copyright. Based on data provided under license from PSMA Australia Limited ([www.pasma.com.au](http://www.pasma.com.au)).

Product incorporates data which is © 20XX Telstra Corporation Limited, GM Holden Limited, Intelomatics Australia Pty Ltd and Continental Pty Ltd.

B. Third Party Notices for Australia. In addition to the foregoing, the End-User Terms for any Application containing RDS-TMC Traffic Codes for Australia shall contain the following notice: “Product incorporates traffic location codes which is © 20XX Telstra Corporation Limited and its licensors.”

## **AT&T Vehicle Network Carrier Telematics Disclosure**

END USER FOR PURPOSES OF THIS SECTION MEANS YOU AND YOUR HEIRS, EXECUTORS, LEGAL PERSONAL REPRESENTATIVES AND PERMITTED ASSIGNS. FOR PURPOSES OF THIS SECTION “UNDERLYING WIRELESS SERVICE CARRIER” INCLUDES ITS AFFILIATES AND CONTRACTORS AND THEIR RESPECTIVE OFFICERS, DIRECTORS, EMPLOYEES, SUCCESSORS AND ASSIGNS. END USER HAS NO CONTRACTUAL RELATIONSHIP WITH THE UNDERLYING WIRELESS SERVICE CARRIER AND END USER IS NOT A THIRD PARTY BENEFICIARY OF ANY AGREEMENT BETWEEN FORD AND UNDERLYING CARRIER. END USER UNDERSTANDS AND AGREES THAT THE UNDERLYING CARRIER HAS NO LEGAL, EQUITABLE, OR OTHER LIABILITY OF ANY KIND TO END USER. IN ANY EVENT, REGARDLESS OF THE FORM OF THE ACTION, WHETHER FOR BREACH OF CONTRACT, WARRANTY, NEGLIGENCE, STRICT LIABILITY IN TORT OR OTHERWISE, END USER’S EXCLUSIVE REMEDY FOR CLAIMS ARISING IN ANY WAY IN CONNECTION WITH THIS AGREEMENT, FOR ANY CAUSE WHATSOEVER, INCLUDING BUT NOT LIMITED TO ANY FAILURE OR

# Appendices

DISRUPTION OF SERVICE PROVIDED HEREUNDER, IS LIMITED TO PAYMENT OF DAMAGES IN AN AMOUNT NOT TO EXCEED THE AMOUNT PAID BY END USER FOR THE SERVICES DURING THE TWO-MONTH PERIOD PRECEDING THE DATE THE CLAIM AROSE.

(ii) END USER AGREES TO INDEMNIFY AND HOLD HARMLESS THE UNDERLYING WIRELESS SERVICE CARRIER AND ITS OFFICERS, EMPLOYEES, AND AGENTS AGAINST ANY AND ALL CLAIMS, INCLUDING WITHOUT LIMITATION CLAIMS FOR LIBEL, SLANDER, OR ANY PROPERTY DAMAGE, PERSONAL INJURY OR DEATH, ARISING IN ANY WAY, DIRECTLY OR INDIRECTLY, IN CONNECTION WITH THIS AGREEMENT OR THE USE, FAILURE TO USE, OR INABILITY TO USE THE DEVICE EXCEPT WHERE THE CLAIMS RESULT FROM THE UNDERLYING CARRIER'S GROSS NEGLIGENCE OR WILLFUL MISCONDUCT. THIS INDEMNITY WILL SURVIVE THE TERMINATION OF THE AGREEMENT.

(iii) END USER HAS NO PROPERTY RIGHT IN ANY NUMBER ASSIGNED TO THE DEVICE.

(iv) END USER UNDERSTANDS THAT FORD AND THE UNDERLYING CARRIER CANNOT GUARANTY THE SECURITY OF WIRELESS TRANSMISSIONS, AND WILL NOT BE LIABLE FOR ANY LACK OF SECURITY RELATING TO THE USE OF THE SERVICES

THE SERVICE IS FOR [END USER'S] USE ONLY AND END USER MAY NOT RESELL THE SERVICE TO ANY OTHER PARTY END USER UNDERSTANDS THAT THE UNDERLYING CARRIER DOES NOT GUARANTEE ANY END USER UNINTERRUPTED SERVICE OR COVERAGE. THE UNDERLYING CARRIER DOES NOT WARRANT THAT END USERS CAN OR WILL BE LOCATED USING THE SERVICE. THE UNDERLYING CARRIER

MAKES NO WARRANTY, EXPRESS OR IMPLIED, OF MERCHANTABILITY OR FITNESS FOR A PARTICULAR PURPOSE, SUITABILITY, OR PERFORMANCE REGARDING ANY SERVICES OR GOODS, AND IN NO EVENT SHALL AT&T BE LIABLE, WHETHER OR NOT DUE TO ITS OWN NEGLIGENCE, FOR ANY: (A) ACT OR OMISSION OF A THIRD PARTY; (B) MISTAKES, OMISSIONS, INTERRUPTIONS, ERRORS, FAILURES TO TRANSMIT, DELAYS, OR DEFECTS IN THE SERVICE PROVIDED BY OR THROUGH THE UNDERLYING CARRIER; (C) DAMAGE OR INJURY CAUSED BY SUSPENSION OR TERMINATION BY THE UNDERLYING CARRIER; OR (D) DAMAGE OR INJURY CAUSED BY A FAILURE OR DELAY IN CONNECTING A CALL TO ANY ENTITY, INCLUDING 911 OR ANY OTHER EMERGENCY SERVICE. TO THE FULL EXTENT ALLOWED BY LAW, THE END USER RELEASES, INDEMNIFIES AND HOLDS THE UNDERLYING CARRIER HARMLESS FROM AND AGAINST ANY AND ALL CLAIMS OF ANY PERSON OR ENTITY FOR DAMAGES OF ANY NATURE ARISING IN ANY WAY FROM OR RELATING TO, DIRECTLY OR INDIRECTLY, SERVICES PROVIDED BY THE UNDERLYING CARRIER OR ANY PERSON'S USE THEREOF, INCLUDING CLAIMS ARISING IN WHOLE OR IN PART FROM THE ALLEGED NEGLIGENCE OF THE UNDERLYING CARRIER.

## **VII. China Territory**

### ***Personal Use Only***

You agree to use this Data together with [insert name of Client Application] for the solely personal, non-commercial purposes for which you were licensed, and not for service bureau, time-sharing or other similar purposes. Accordingly, but subject to the restrictions set forth in the following paragraphs, you may copy this Data only as necessary for your personal use to (i)

# Appendices

---

view it, and (ii) save it, provided that you do not remove any copyright notices that appear and do not modify the Data in any way. You agree not to otherwise reproduce, copy, modify, decompile, disassemble or reverse engineer any portion of this Data, and may not transfer or distribute it in any form, for any purpose, except to the extent permitted by mandatory laws.

## **Restrictions**

Except where you have been specifically licensed to do so by NAV2, and without limiting the preceding paragraph, you may not (a) use this Data with any products, systems, or applications installed or otherwise connected to or in communication with vehicles, capable of vehicle navigation, positioning, dispatch, real time route guidance, fleet management or similar applications; or (b) with or in communication with any positioning devices or any mobile or wireless-connected electronic or computer devices, including without limitation cellular phones, palmtop and handheld computers, pagers, and personal digital assistants or PDAs. You agree to cease using this Data if you fail to comply with these terms and conditions.

## **Limited Warranty**

NAV2 warrants that (a) the Data will perform substantially in accordance with the accompanying written materials for a period of ninety (90) days from the date of receipt, and (b) any support services provided by NAV2 shall be substantially as described in applicable written materials provided to you by NAV2, and NAV2's support engineers will make commercially reasonable efforts to solve any problem issues.

## **rigCustomer Remedies**

NAV2 and its suppliers' entire liability and your exclusive remedy shall be, at NAV2's sole discretion, either (a) return of the price paid, if any, or (b) repair or replacement of the Data that do not meet NAV2's Limited Warranty and that are returned to NAV2 with a copy of your receipt. This Limited Warranty is void if failure of the Data has resulted from accident, abuse, or misapplication. Any replacement Data will be warranted for the remainder of the original warranty period or thirty (30) days, whichever is longer. Neither these remedies nor any product support services offered by NAV2 are available without proof of purchase from an authorized international source.

## **No Other Warranty:**

EXCEPT FOR THE LIMITED WARRANTY SET FORTH ABOVE AND TO THE EXTENT PERMITTED BY APPLICABLE LAW, NAV2 AND ITS LICENSORS (INCLUDING THEIR LICENSORS AND SUPPLIERS) DISCLAIM ANY WARRANTIES, EXPRESS OR IMPLIED, OF QUALITY, PERFORMANCE, MERCHANTABILITY, FITNESS FOR A PARTICULAR PURPOSE, OWNERSHIP OR NON-INFRINGEMENT. Certain warranty exclusions may not be permitted under applicable law, so to that extent the above exclusion may not apply to you.

## **Limited Liability:**

TO THE EXTENT PERMITTED BY APPLICABLE LAW, NAV2 AND ITS LICENSORS (INCLUDING THEIR LICENSORS AND SUPPLIERS) SHALL NOT BE LIABLE TO YOU: IN RESPECT OF ANY CLAIM, DEMAND OR ACTION, IRRESPECTIVE OF THE NATURE OF THE CAUSE OF THE CLAIM, DEMAND OR ACTION ALLEGING ANY LOSS, INJURY OR DAMAGES, DIRECT OR INDIRECT, WHICH MAY RESULT FROM THE USE OR POSSESSION OF THE INFORMATION; OR

# Appendices

---

FOR ANY LOSS OF PROFIT, REVENUE, CONTRACTS OR SAVINGS, OR ANY OTHER DIRECT, INDIRECT, INCIDENTAL, SPECIAL OR CONSEQUENTIAL DAMAGES ARISING OUT OF YOUR USE OF OR INABILITY TO USE THIS INFORMATION, ANY DEFECT IN THE INFORMATION, OR THE BREACH OF THESE TERMS OR CONDITIONS, WHETHER IN AN ACTION IN CONTRACT OR TORT OR BASED ON A WARRANTY, EVEN IF NAV2 OR ITS LICENSORS HAVE BEEN ADVISED OF THE POSSIBILITY OF SUCH DAMAGES. UNDER NO CIRCUMSTANCES SHALL NAV2'S OR ITS SUPPLIERS' LIABILITY HEREUNDER EXCEED THE PRICE PAID. Certain liability exclusions may not be permitted under applicable law, so to that extent the above exclusion may not apply to you.

## **Export Control**

You agree not to export to anywhere any part of the Data provided to you or any direct product thereof except in compliance with, and with all licenses and approvals required under, applicable export laws, rules and regulations.

## **IP Protection**

The Data are owned by NAV2 or its suppliers and are protected by applicable copyright and other intellectual property law and treaties. The Data are provided solely on the basis of a license to use, not sale.

## **Entire Agreement**

These terms and conditions constitute the entire agreement between NAV2 (and its licensors, including their licensors and suppliers) and you pertaining to the subject matter hereof, and supersedes in their entirety any and all written or oral agreements previously existing between us with respect to such subject matter.

## **Governing Law.**

The above terms and conditions shall be governed by the laws of the People's Republic of China, without giving effect to (i) its conflict of laws provisions, or (ii) the United Nations Convention for Contracts for the International Sale of Goods, which is explicitly excluded. Any dispute arising from or in connection with the Data provided to you hereunder shall be submitted to the Shanghai International Economic and Trade Arbitration Commission for arbitration.

## **Gracenote® Copyright**

CD and music-related data from Gracenote, Inc., copyright©

2000-2007 Gracenote. Gracenote Software, copyright © 2000-2007 Gracenote. This product and service may practice one or more of the following U.S. Patents 5,987,525; 6,061,680; 6,154,773; 6,161,132; 6,230,192; 6,230,207; 6,240,459; 6,330,593 and other patents issued or pending. Some services supplied under license from Open Globe, Inc. for U.S. Patent 6,304,523.

Gracenote and CDDB are registered trademarks of Gracenote. The Gracenote logo and logotype, and the "Powered by Gracenote™" logo are trademarks of Gracenote.

## **Gracenote® End User License Agreement (EULA)**

This device contains software from Gracenote, Inc. of 2000 Powell Street Emeryville, California 94608 ("Gracenote").

The software from Gracenote (the "Gracenote Software") enables this device to do disc and music file identification and obtain music-related information, including name, artist, track, and title information ("Gracenote Data") from online servers

## Appendices

---

("Gracenote Servers"), and to perform other functions. You may use Gracenote Data only by means of the intended End User functions of this device. This device may contain content belonging to Gracenote's providers. If so, all of the restrictions set forth herein with respect to Gracenote Data shall also apply to such content and such content providers shall be entitled to all of the benefits and protections set forth herein that are available to Gracenote. You agree that you will use the content from Gracenote ("Gracenote Content"), Gracenote Data, the Gracenote Software, and Gracenote Servers for your own personal, non-commercial use only. You agree not to assign, copy, transfer or transmit the Gracenote Content, Gracenote Software or any Gracenote Data (except in a Tag associated with a music file) to any third party. YOU AGREE NOT TO USE OR EXPLOIT GRACENOTE CONTENT, GRACENOTE DATA, THE GRACENOTE SOFTWARE, OR GRACENOTE SERVERS, EXCEPT AS EXPRESSLY PERMITTED HEREIN.

You agree that your non-exclusive licenses to use the Gracenote Content, Gracenote Data, the Gracenote Software, and Gracenote Servers will terminate if you violate these restrictions. If your licenses terminate, you agree to cease any and all use of the Gracenote Content, Gracenote Data, the Gracenote Software, and Gracenote Servers.

Gracenote, respectively, reserve all rights in Gracenote Data, the Gracenote Software, and the Gracenote Servers and Gracenote Content, including all ownership rights. Under no circumstances will either Gracenote become liable for any payment to you for any information that you provide,

including any copyrighted material or music file information. You agree that Gracenote may enforce its respective rights, collectively or separately, under this agreement against you, directly in each company's own name.

Gracenote uses a unique identifier to track queries for statistical purposes. The purpose of a randomly assigned numeric identifier is to allow Gracenote to count queries without knowing anything about who you are. For more information, see the web page at [www.gracenote.com](http://www.gracenote.com) for the Gracenote Privacy Policy.

THE GRACENOTE SOFTWARE, EACH ITEM OF GRACENOTE DATA AND THE GRACENOTE CONTENT ARE LICENSED TO YOU "AS IS". NEITHER GRACENOTE MAKES ANY REPRESENTATIONS OR WARRANTIES, EXPRESS OR IMPLIED, REGARDING THE ACCURACY OF ANY GRACENOTE DATA FROM THE GRACENOTE SERVERS OR GRACENOTE CONTENT. GRACENOTE COLLECTIVELY AND SEPARATELY RESERVE THE RIGHT TO DELETE DATA AND/OR CONTENT FROM THE COMPANIES' RESPECTIVE SERVERS OR, IN THE CASE OF GRACENOTE, CHANGE DATA CATEGORIES FOR ANY CAUSE THAT GRACENOTE DEEMS SUFFICIENT. NO WARRANTY IS MADE THAT EITHER GRACENOTE CONTENT OR THE GRACENOTE SOFTWARE OR GRACENOTE SERVERS ARE ERROR-FREE OR THAT THE FUNCTIONING OF THE GRACENOTE SOFTWARE OR GRACENOTE SERVERS WILL BE UNINTERRUPTED. GRACENOTE IS NOT OBLIGATED TO PROVIDE YOU WITH ANY ENHANCED OR ADDITIONAL DATA TYPES THAT GRACENOTE MAY CHOOSE TO PROVIDE IN THE FUTURE AND IS FREE TO DISCONTINUE ITS ONLINE SERVICES AT ANY TIME. GRACENOTE DISCLAIM ALL WARRANTIES EXPRESS OR IMPLIED, INCLUDING, BUT NOT LIMITED TO,

# Appendices

IMPLIED WARRANTIES OF MERCHANTABILITY, FITNESS FOR A PARTICULAR PURPOSE, TITLE, AND NON-INFRINGEMENT. NEITHER GRACENOTE WARRANTS THE RESULTS THAT WILL BE OBTAINED BY YOUR USE OF THE GRACENOTE SOFTWARE OR ANY GRACENOTE SERVER. IN NO CASE WILL GRACENOTE BE LIABLE FOR ANY CONSEQUENTIAL OR INCIDENTAL DAMAGES OR FOR ANY LOST PROFITS OR LOST REVENUES FOR ANY REASON WHATSOEVER. © Gracernote 2007.

## Radio Frequency Statement

FCC ID: ACJ-SYNCG3-L

IC: 216B-SYNCG3-L

This device complies with Part 15 of the FCC Rules and with RSS-210 of Industry Canada. Operation is subject to the following two conditions:

- (1) This device may not cause harmful interference, and
- (2) this device must accept any interference received, including interference that may cause undesired operation.

### WARNING



Changes or modifications not expressly approved by the party responsible for compliance could void the user's authority to operate the equipment. The term "IC:" before the radio certification number only signifies that Industry Canada technical specifications were met.

The antenna used for this transmitter must not be co-located or operating in conjunction with any other antenna or transmitter.

## Taiwan Territory

Note: In accordance with the management approach of low-power radio wave radiation motors:

Article 12: For approved and certified low-power radiation motor models, companies, firms or users must not alter the frequency, increase the power or change the characteristics and functions of the original design without authorization.

Article 14: The usage of low-power radio-frequency motors must not affect aviation safety and interfere with legal telecommunications. Should interference be detected, immediately stop using the device and only resume usage after ensuring that there is no longer any interference. For the legal telecommunication and wireless telecommunication of the telco, the low-power radio frequency motor must be able to tolerate legal limits of interference from telecommunication, industrial, scientific and radio wave equipment.

## SUNA TRAFFIC CHANNEL – TERMS AND CONDITIONS

By activating, using and/or accessing the SUNA Traffic Channel, SUNA Predictive or other content or material provided by Intelomatics (together, **SUNA Products and/or Services**), you must accept certain terms and conditions. The following is a brief summary of the terms and conditions that apply to you. To view the full terms and conditions relevant to your use of the SUNA Products and/or Services, please consult:

### Website

[www.sunatraffic.com.au/termsandconditions/](http://www.sunatraffic.com.au/termsandconditions/)

## 1. Acceptance

# Appendices

By using SUNA Products and/or Services, you will be deemed to have accepted and agreed to be bound by the terms and conditions fully detailed at:

Website
<a href="http://www.sunattraffic.com.au/termsandconditions/">www.sunattraffic.com.au/termsandconditions/</a>

## 2. Intellectual Property

SUNA Products and/or Services are for your personal use. You may not record, or retransmit the content, nor use the content in association with any other traffic information or route guidance service or device not approved by Intelematics. You obtain no right of ownership in any Intellectual Property Rights (including copyright) in the data that is used to provide SUNA Products and/or Services.

## 3. Appropriate Use

SUNA Products and/or Services are intended as an aid to personal motoring and travel planning, and do not provide comprehensive or accurate information on all occasions. On occasions, you may experience additional delay as a result of using SUNA Products and/or Services. You acknowledge that it is not intended, or suitable, for use in applications where time of arrival or driving directions may impact the safety of the public or yourself.

## 4. Use of SUNA Products and Services while driving

You, and other authorised drivers of the vehicle in which SUNA Products and/or Services are available or installed and active, remain at all times responsible for observing all relevant laws and codes of safe driving. In particular, you agree to only actively operate SUNA Products and/or Services when the Vehicle is at a complete stop and it is safe to do so.

## 5. Service Continuity and Reception of the SUNA Traffic Channel

We will use reasonable endeavours to provide the SUNA Traffic Channel 24 hours a day, 365 days a year. The SUNA Traffic Channel may occasionally be unavailable for technical reasons or for planned maintenance. We will try to perform maintenance at times when congestion is light. We reserve the right to withdraw SUNA Products and/or Services at any time.

Also, we cannot assure the uninterrupted reception of the SUNA Traffic Channel RDS-TMC signal at any particular location.

## 6. Limitation of Liability

Neither Intelematics (nor its suppliers or the manufacturer of your device (the “**Suppliers**”)) shall be liable to you or to any third party for any damages either direct, indirect, incidental, consequential or otherwise arising out of the use of or inability to use SUNA Products and/or Services even if Intelematics or a Supplier has been advised of the possibility of such damages. You also acknowledge that the neither Intelematics nor any Supplier guarantees nor make any warranties that relate to the availability, accuracy or completeness of SUNA Products and/or Services, and to the extent which it is lawful to do so, both Intelematics and each Supplier excludes any warranties which might otherwise be implied by any State or Federal legislation in relation to SUNA Products and/or Services.

## 7. Please Note

Great care has been taken in preparing this manual. Constant product development may mean that some information is not entirely up-to-date. The information in this document is subject to change without notice.

# Appendices

## WARNING



Driving while distracted can result in loss of vehicle control, crash and injury. We strongly recommend that you use extreme caution when using any device that may take your focus off the road. Your primary responsibility is the safe operation of your vehicle. We recommend against the use of any hand-held device while driving and encourage the use of voice-operated systems when possible. Make sure you are aware of all applicable local laws that may affect the use of electronic devices while driving.

## TYPE APPROVALS

### RF Certification Logos for Tire Pressure Monitoring Sensor(s)



E207816

Argentina



E197509

Brazil

Herby, Schrader Electronics UK Ltd., declares that this TPMS is in compliance with the essential requirements and other provisions of directive 1999/5/EC. The declaration of conformity may be consulted at [emcteam@schrader.co.uk](mailto:emcteam@schrader.co.uk)

E207818

European Union EU

**NCA APPROVED: 3R88M14030**

E253824

Ghana

Kingdom of Jordan Type approval for tyre pressure sensor  
Model : AG2SZ4  
Manufacturer:Schrader Electronics Ltd  
Type Approval Number:TRC/LPD/2014/56  
Equipment Type: Low Power Device (LPD)

E253823

Jordan



E253822

Malaysia

**IFT: RLVSCMR15-1238**

E253812

**IFT: RLVSCMR15-1249**

E253813



# Appendices

Mexico



E197811

Moldova



E207821

Morocco

**OMAN TRA**  
**TA-R/1752/14**  
**D090258**

E253817

Oman



**Type Approved**

**NTC**

**No:ESD-1408639C**

E198001

Philippines

**EAC**

E253816

Russia



E197844

Serbia

Complies with  
IDA Standards  
DA 105282

E253820

Singapore



**TA-2014/064**

**Approved**

E198002

South Africa



E253819

MSIP-CRM-SRD-AG2SZ4

South Korea

# Appendices

## RF Certification Logos for Mid Range Radar



CCAM14LP0090T3

E203679

Taiwan

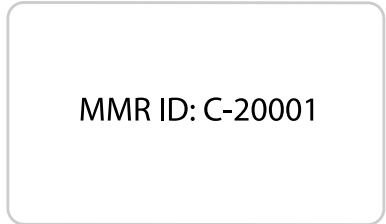

E269659

Argentina



E253818

Ukraine

**109**

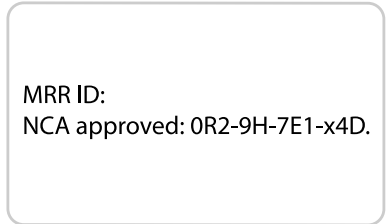

E207817

United Arab Emirates

E269662

Ghana

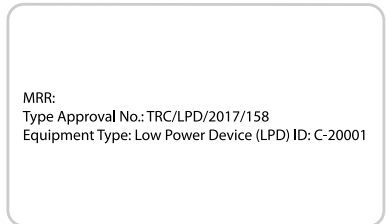

E269660

Jordan

# Appendices

---

MRR ID:  
No. D'Agreement: MR 13639 ANRT 2017 (28 March 2017)

E269661

Morocco

MRR ID:  
TA-2017/370

E269664

South Africa

MRR ID:  
ER54071/17, Dealer License Number (WAC Dealer License Number: DA37380/15)

E269663

United Arab Emirates

## RF Certification Logos for Passive Anti-Theft System



E269675

Brazil

NCA PRODUCT IDENTIFIER: NCA/TA/16/22

E269674

Ghana

Type approval No.: TRC/LPD/2013/235  
Equipment Type: Low Power Device (LPD)

E269666

Jordan

# Appendices



E269673

Malaysia

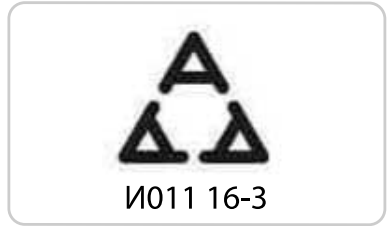

E269672

Serbia



E269670

Morocco

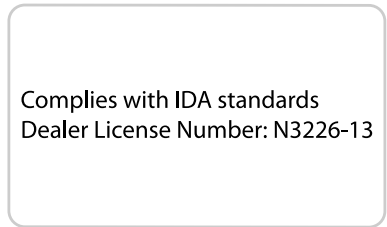

E269676

Singapore



E269669

Pakistan



E269667

South Africa

# Appendices

ID No. 1O094.004449-16



E269671

Ukraine

TRA  
REGISTERED No. ER49115/16

E269668

United Arab Emirates

So.No: A0364120416AF04A2



E269677

Vietnam

## RF Certification Logos for Radio Transceiver Module

N° D'AGRÉMENT: MR 12432 ANRT 2016

E269683

Morocco



TAC NO: 14.1008/2015

E269684

Pakistan



И011 16

E269681

Serbia

# Appendices



E269685

South Africa



E269697

Malaysia



E269682

Ukraine



E269696

South Africa

## RF Certification Logos for Blind Spot Information System

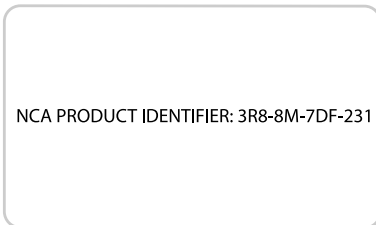

E269695

Ghana

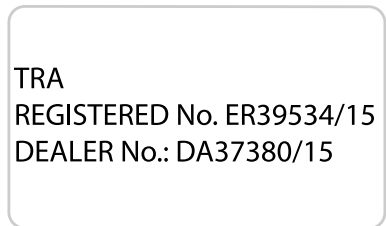

E269694

United Arab Emirates

# Appendices

---

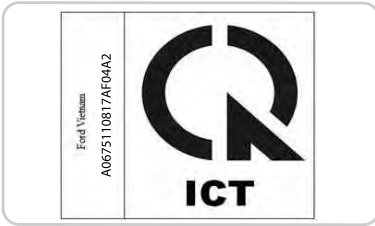

E269693

United Arab Emirates

# Index

## 3

360 Degree Camera.....	239
Advanced Camera Views.....	239
Auxiliary Camera.....	242
Camera Views.....	239
Center High-Mount Stop Lamp Camera.....	241
Front Camera.....	240
Keep Out Zone.....	240
Side Camera.....	241

## 4

4WD	
See: Four-Wheel Drive.....	214

## A

A/C	
See: Climate Control.....	146
About This Manual.....	7
ABS	
See: Brakes.....	225
ABS driving hints	
See: Hints on Driving With Anti-Lock Brakes.....	227
Accessories.....	574
Exterior style.....	574
Interior style.....	574
Lifestyle.....	574
Peace of mind.....	574
Accessories	
See: Replacement Parts Recommendation.....	12
ACC	
See: Using Adaptive Cruise Control.....	244
Adjusting the Headlamps.....	355
Horizontal Aim Adjustment.....	357
Vertical Aim Adjustment.....	355
Adjusting the Pedals.....	86
Adjusting the Steering Wheel - Vehicles With: Manual Adjustable Steering Column.....	82
Adjusting the Steering Wheel - Vehicles With: Power Adjustable Steering Column.....	82
End of Travel Position.....	83
Airbag Disposal.....	55
Air Conditioning	
See: Climate Control.....	146
Air Filter	
See: Changing the Engine Air Filter - 6.2L/ 6.8L.....	362
See: Changing the Engine Air Filter - 6.7L Diesel.....	363
Alarm	
See: Anti-Theft Alarm.....	78
Ambient Lighting.....	97
Anti-Theft Alarm.....	78
Arming the Alarm.....	79
Disarming the Alarm.....	79
Using the System.....	79
Appendices.....	609
Apps.....	543
SiriusXM Traffic and Travel Link.....	545
At a Glance.....	17
Audible Warnings and Indicators.....	112
Headlamps On Warning Chime.....	112
Key in Ignition Warning Chime.....	112
Parking Brake On Warning Chime.....	112
Audio Control.....	83
Media.....	84
Seek, Next or Previous.....	84
Audio System.....	445
General Information.....	445
Audio Unit - Vehicles With: AM/FM/CD/ SYNC.....	448
Menu Structure.....	450
Audio Unit - Vehicles With: AM/FM/CD/ Touchscreen Display.....	453
Audio Unit - Vehicles With: AM/ FM.....	446
Autolamps.....	90
Windshield Wiper Activated Headlamps.....	90
Automatic Climate Control.....	147
Automatic High Beam Control.....	92
Automatic High Beam Indicator.....	93
Switching the System On and Off.....	92
Automatic Transmission.....	208
Brake-Shift Interlock.....	211
If Your Vehicle Gets Stuck In Mud or Snow.....	212



# Index

Understanding the Shift Positions of Your Automatic Transmission.....	208
Understanding your SelectShift Automatic™ transmission.....	210
Automatic Transmission Fluid	
Check.....	346
Checking Automatic Transmission Fluid.....	346
Autowipers.....	87
Auxiliary Power Points.....	170
110 Volt - 400 Watt Capacity AC Power Outlet.....	170
12 Volt DC Power Point.....	170
Locations.....	170
Auxiliary Switches.....	575
Upfitter Interface Module.....	578
<b>B</b>	
Battery	
See: Changing the 12V Battery.....	353
Bed Extender.....	74
Grocery mode.....	75
Tailgate mode.....	74
Bed Ramps.....	268
Installing the Ramp Holder.....	270
Stowing the Bed Ramp.....	270
Using the Bed Ramp.....	269
Blind Spot Information System.....	252
Blind Spot Information System with Trailer Tow.....	254
Switching the System Off and On.....	256
System Errors.....	256
Using the System.....	253
BLIS	
See: Blind Spot Information System.....	252
Bonnet Lock	
See: Opening and Closing the Hood.....	328
Booster Seats.....	32
Types of Booster Seats.....	32
Brake Fluid Check.....	349
Brakes.....	225
General Information.....	225
Breaking-In.....	298
Bulb Specification Chart.....	360

## C

Cabin Air Filter.....	152
California Proposition 65.....	12
Capacities and Specifications -	
6.2L.....	427
Alternative Engine Oil for Extremely Cold Climates.....	431
Specifications.....	428
Capacities and Specifications - 6.7L	
Diesel.....	432
Engine Oil Specifications.....	438
Specifications.....	434
Capacities and Specifications -	
6.8L.....	439
Alternative Engine Oil for Extremely Cold Climates.....	443
Specifications.....	440
Capacities and Specifications.....	420
Cargo Lamps.....	97
Car Wash	
See: Cleaning the Exterior.....	370
Catalytic Converter.....	196
On-Board Diagnostics (OBD-II).....	197
Readiness for Inspection and Maintenance (I/M) Testing.....	197
Center Console.....	172
Changing a Bulb.....	357
Cargo Lamp and Central High Mounted Brake Lamp Bulbs.....	359
Fog Lamp Bulbs.....	358
Front Park and Direction Indicator Lamp Bulbs.....	357
Headlamp Bulbs.....	357
License Plate Lamp Bulb.....	360
Rear Lamps, Brake Lamps, Rear Direction Indicator and Reversing Lamp Bulbs.....	358
Changing a Fuse.....	326
Fuses.....	326
Changing a Road Wheel.....	408
Dissimilar Spare Wheel and Tire Assembly Information.....	408
Location of the Spare Tire and Tools.....	409
Removing the Spare Tire (With Spare Tire Carrier Only).....	409
Tire Change Procedure.....	410

# Index

Changing the 12V Battery.....	353	Cleaning the Instrument Panel and Instrument Cluster Lens.....	375
Battery Management System.....	354	Cleaning the Interior.....	373
Changing the Crankcase Vent Filter Element.....	336	Cleaning the Wheels.....	377
Changing the Engine Air Filter - 6.2L/6.8L.....	362	Cleaning the Windows and Wiper Blades.....	373
Changing the Engine Air Filter - 6.7L Diesel.....	363	Clearing All MyKeys.....	65
Air Filter Restriction Gauge.....	364	Climate.....	527
Changing the Engine-Mounted and Diesel Fuel Conditioner Module Fuel Filters - 6.7L Diesel.....	365	Climate Control.....	146
Diesel Fuel Conditioner Module Filter.....	365	Climate Controlled Seats.....	163
Engine-mounted Fuel Filter.....	368	Cooled Seats.....	164
Changing the Engine Oil and Oil Filter.....	335	Heated Seats.....	163
Engine lubrication for severe service operation.....	336	Collision Warning System.....	261
Changing the Wiper Blades.....	355	Principle Of Operation.....	261
Checking MyKey System Status.....	65	Coolant Check	
MyKey Distance.....	65	See: Engine Coolant Check - 6.2L/6.8L....	338
Number of Admin Keys.....	65	See: Engine Coolant Check - 6.7L Diesel.....	342
Number of MyKeys.....	65	Crash Sensors and Airbag Indicator.....	54
Checking the Wiper Blades.....	355	Creating a MyKey.....	64
Child Restraint and Seatbelt Maintenance.....	44	Programming or Changing Configurable Settings.....	64
Child Restraint Positioning.....	34	Cross Traffic Alert.....	257
Child Safety.....	19	False Alerts.....	259
General Information.....	19	Switching the System Off and On.....	259
Child Safety Locks.....	35	System Errors.....	259
Left-Hand Side.....	36	System Lights, Messages and Audible Alerts.....	258
Right-Hand Side.....	36	System Limitations.....	259
Cleaning Leather Seats.....	375	Using the System.....	257
With King Ranch Edition.....	376	Cruise Control.....	84
Without King Ranch Edition.....	375	Principle of Operation.....	243
Cleaning Products.....	370	Cruise control	
Materials.....	370	See: Using Cruise Control.....	243
Cleaning the Engine.....	372	Customer Assistance.....	310
Cleaning the Exhaust - 6.7L Diesel.....	372	<b>D</b>	
Cleaning the Exterior.....	370	Data Recording.....	10
Cleaning the Headlamps.....	371	Event Data Recording.....	10
Exterior Chrome Parts.....	371	Service Data Recording.....	10
Exterior Plastic Parts.....	371	Daytime Running Lamps.....	91
Stripes or Graphics.....	371	Type One - Conventional (Non-Configurable).....	91
Underbody.....	371	Type Two - Configurable.....	91
Under Hood.....	371	Diesel Particulate Filter.....	202
		Oxidation Catalytic Converter and Diesel Particulate Filter System.....	203

# Index

Regeneration.....	202
Digital Radio.....	454
HD Radio Reception and Station Troubleshooting.....	455
Direction Indicators.....	93
Doors and Locks.....	67
Draining the Fuel Filter Water Trap - 6.7L Diesel.....	351
Draining the Diesel Fuel Conditioner Module.....	351
Filter Location.....	351
Driver and Passenger Airbags.....	47
Children and Airbags.....	52
Passenger Airbag On and Off Switch .....	47
Proper Driver and Front Passenger Seating Adjustment.....	51
Driving Aids.....	250
Driving Hints.....	298
Driving Through Water.....	299
DRL See: Daytime Running Lamps.....	91

## E

Economical Driving.....	298
Electromagnetic Compatibility.....	609
Electronic Locking Differential.....	223
Activating the Electronic Locking Differential.....	223
Emission Law.....	195
Noise Emissions Warranty, Prohibited Tampering Acts and Maintenance.....	196
Tampering With a Noise Control System.....	195
End User License Agreement.....	611
VEHICLE SOFTWARE END USER LICENSE AGREEMENT (EULA) .....	611
Engine Block Heater.....	183
Using the Engine Block Heater.....	184
Engine Coolant Check - 6.2L/6.8L.....	338
Adding Coolant.....	338
Engine Coolant Temperature Management.....	341
Fail-Safe Cooling.....	340
Recycled Coolant.....	339
Severe Climates.....	340
Engine Coolant Check - 6.7L Diesel.....	342
Adding Coolant.....	342
Checking Coolant Corrosion Inhibitor Additive Strength .....	345
Coolant Change.....	346
Engine and Secondary Cooling System Refill Procedure.....	344
Engine-driven Cooling Fan (Fan Clutch).....	346
Recycled Coolant.....	344
Severe Climates.....	344
Engine Emission Control.....	195
Engine Idle Shutdown.....	183
Engine Immobilizer See: Passive Anti-Theft System.....	76
Engine Oil Check - 6.2L/6.8L.....	333
Adding Engine Oil.....	333
Engine Oil Check - 6.7L Diesel.....	334
Adding Engine Oil.....	335
Engine lubrication for severe service operation .....	335
Engine Oil Dipstick - 6.2L/6.8L.....	333
Engine Oil Dipstick - 6.7L Diesel.....	333
Engine Specifications - 6.2L.....	420
Drivebelt Routing.....	420
Engine Specifications - 6.7L Diesel.....	420
.....	420
Drivebelt Routing.....	421
Engine Specifications - 6.8L.....	421
Drivebelt Routing.....	422
Entertainment.....	517
AM/FM Radio.....	518
Apps.....	526
Bluetooth Stereo or USB.....	525
CD (If equipped).....	524
HD Radio™ Information (If Available).....	521
SiriusXM® Satellite Radio (If Activated).....	519
Sources.....	518
Supported Media Players, Formats and Metadata Information.....	526
USB Ports.....	526
Environment.....	16
Essential Towing Checks.....	286
Before Towing a Trailer.....	293

# Index

Dynamic Hitching Using the Rear View Camera System.....	287
Hitches.....	288
Integrated Trailer Brake Controller.....	290
Launching or Retrieving a Boat or Personal Watercraft (PWC).....	294
Safety Chains.....	290
Trailer Brakes.....	290
Trailer Lamps.....	293
Trailer Towing Connector.....	286
When Towing a Trailer.....	294
Event Data Recording See: Data Recording.....	10
Export Unique Options.....	15
Exterior Mirrors.....	99
Blind Spot Information System.....	101
Clearance Lamps.....	101
Direction Indicator Mirrors.....	101
Fold-Away Exterior Mirrors.....	99
Heated Exterior Mirrors.....	101
Memory Mirrors.....	101
Power Exterior Mirrors.....	99
PowerScope™ Power Telescoping Mirrors.....	100
Puddle Lamps.....	101
Spot Lamps.....	101
Telescoping Mirrors.....	100
Trailer Towing Camera System.....	101
<b>F</b>	
Fastening the Seatbelts.....	38
Fastening the Cinch Tongue.....	39
Rear Inflatable Seatbelt.....	41
Seatbelt Locking Modes.....	40
Using Seatbelts During Pregnancy.....	39
Using the Seatbelt with Cinch Tongue (Front Center Seat on Super Cab and Crew Cab).....	38
Flat Tire See: Changing a Road Wheel.....	408
Floor Mats.....	299
Fog Lamps - Front See: Front Fog Lamps.....	93
Foot Pedals See: Adjusting the Pedals.....	86
Ford Credit.....	12
US Only.....	12
Ford Protect.....	579
Ford Protect Extended Service Plan (CANADA ONLY).....	580
Ford Protect Extended Service Plans (U.S. Only).....	579
Four-Wheel Drive.....	214
Front Fog Lamps.....	93
Front Seat Armrest.....	164
Fuel and Refueling.....	185
Fuel Consumption.....	193
Fuel Economy.....	194
Fuel Filter - 6.2L/6.8L.....	352
Fuel Quality - Diesel.....	187
Biodiesel.....	188
Diesel Fuel Additives.....	189
Fuel Requirements - Choosing The Right Fuel: Vehicles Operated Where Ultra Low Sulfur Diesel Fuel Is Not Required.....	187
Fuel Requirements - Choosing The Right Fuel: Vehicles Operated Where Ultra Low Sulfur Diesel Fuel Is Required (United States/Canada/Puerto Rico/U.S. Virgin Islands And Other Locales).....	187
Fuel Quality - E85.....	186
Choosing the Right Fuel - Flex Fuel Vehicles.....	186
Switching Between E85 and Gasoline.....	187
Fuel Quality - Gasoline.....	189
Choosing the Right Fuel.....	189
Fuel Shutoff.....	304
Fuses.....	317
Fuse Specification Chart.....	317
Passenger Compartment Fuse Panel.....	323
Power Distribution Box.....	317
<b>G</b>	
Garage Door Opener See: Universal Garage Door Opener.....	166
Gauges.....	105
DEF Gauge.....	108
Engine Coolant Temperature Gauge.....	107
Engine Oil Pressure Gauge.....	106
Fuel Gauge.....	107
Transmission Fluid Temperature Gauge.....	108

# Index

Turbo Boost Gauge.....	108
Type 1 and 2.....	105
Type 3.....	106
<b>Gearbox</b>	
See: Transmission.....	208
<b>General Information on Radio</b>	
Frequencies.....	56
Intelligent Access.....	56
<b>General Maintenance Information.....</b>	<b>581</b>
Multi-Point Inspection.....	583
Owner Checks and Services.....	582
Protecting Your Investment.....	581
Why Maintain Your Vehicle?.....	581
Why Maintain Your Vehicle at Your Dealership?.....	581
<b>Getting Assistance Outside the U.S. and Canada.....</b>	<b>313</b>
<b>Getting the Services You Need.....</b>	<b>310</b>
Away From Home.....	310
<b>Global Opening.....</b>	<b>99</b>
Opening the Windows.....	99
<b>H</b>	
<b>Handbrake</b>	
See: Parking Brake.....	227
<b>Hazard Flashers.....</b>	<b>304</b>
<b>HDC</b>	
See: Using Hill Descent Control.....	233
<b>Headlamp Adjusting</b>	
See: Adjusting the Headlamps.....	355
<b>Headrest</b>	
See: Head Restraints.....	154
<b>Head Restraints.....</b>	<b>154</b>
Adjusting the Head Restraint.....	155
<b>Heated Exterior Mirrors.....</b>	<b>152</b>
<b>Heated Rear Window.....</b>	<b>152</b>
<b>Heated Seats.....</b>	<b>162</b>
Rear Heated Seats.....	163
<b>Heated Steering Wheel.....</b>	<b>85</b>
<b>Heating</b>	
See: Climate Control.....	146
<b>Hill Start Assist.....</b>	<b>227</b>
Switching the System On and Off.....	228
Using Hill Start Assist.....	228
<b>Hints on Controlling the Interior</b>	
Climate.....	149
Defogging the Side Windows in Cold Weather.....	151
General Hints.....	149
Quickly Cooling the Interior.....	151
Quickly Heating the Interior.....	150
Recommended Settings for Cooling.....	151
Recommended Settings for Heating.....	150
<b>Hints on Driving With Anti-Lock Brakes.....</b>	<b>227</b>
<b>Home Screen.....</b>	<b>509</b>
<b>Hood Lock</b>	
See: Opening and Closing the Hood.....	328
<b>I</b>	
<b>Ignition Switch.....</b>	<b>175</b>
<b>In California (U.S. Only).....</b>	<b>311</b>
<b>Information Display Control.....</b>	<b>85</b>
<b>Information Displays.....</b>	<b>113</b>
General Information.....	113
<b>Information Messages.....</b>	<b>129</b>
4WD.....	145
Active Park.....	129
Adaptive Cruise Control.....	130
Adaptive Steering.....	130
AdvanceTrac and Traction Control.....	131
Airbag.....	131
Alarm and Security.....	131
Automatic Engine Shutdown.....	132
Battery and Charging System.....	132
Blind Spot Information and Cross Traffic Alert System.....	133
Collision Warning System.....	134
Diesel Messages.....	134
Doors and Locks.....	136
Driver Alert.....	137
Drivetrain.....	137
Engine.....	137
Fuel.....	138
Keys and Intelligent Access.....	138
Lane Keeping System.....	139
Maintenance.....	139
MyKey.....	140
Off Road.....	140
Park Aid.....	141
Park Brake.....	141

# Index

Power Steering.....	142	Removing the Jumper Cables.....	306
Remote Start.....	142	<b>K</b>	
Seats.....	142	Keyless Entry.....	70
Starting System.....	143	SECURICODE™ KEYLESS ENTRY	
Tire Pressure Monitoring System.....	143	KEYPAD.....	70
Trailer.....	143	Keyless Starting.....	176
Installing Child Restraints.....	20	Ignition Modes.....	176
Child Seats.....	20	Keys and Remote Controls.....	56
Combining Seatbelt and LATCH Lower Anchors for Attaching Child Safety Seats.....	29	<b>L</b>	
Front Seat Tether Strap Attachment (Regular Cab).....	30	Lane Keeping System.....	250
Rear Seat Tether Strap Attachment (Crew Cab and Super Cab).....	31	Switching the System On and Off.....	250
Use of Inboard Lower Anchors from the Outboard Seating Positions (Center Seating Use).....	28	System Display.....	251
Using Inflatable Seatbelts (Rear Seat Outboard Positions).....	25	System Settings.....	250
Using Lap and Shoulder Belts (Except Front Center Position of Super Cab and Crew Cab).....	21	Troubleshooting.....	251
Using Lap and Shoulder Belts (Front Center Position of Super Cab and Crew Cab).....	23	Lighting Control.....	89
Using Lower Anchors and Tethers for Children (LATCH).....	27	Headlamp Flasher.....	90
Using Tether Straps.....	29	Headlamp High Beam.....	89
Instrument Cluster.....	105	Lighting.....	89
Instrument Lighting Dimmer.....	90	General Information.....	89
Vehicles With Front Fog Lamps.....	91	Limited Slip Differential.....	223
Vehicles Without Front Fog Lamps.....	91	Load Carrying.....	264
Instrument Panel Overview.....	17	Load Limit.....	264
Interior Lamps.....	94	Special Loading Instructions for Owners of Pick-up Trucks and Utility-type Vehicles.....	268
Front Interior Lamps.....	94	Vehicle Loading - with and without a Trailer.....	264
Rear Interior Lamps.....	96	Locking and Unlocking.....	67
Interior Mirror.....	101	Activating Intelligent Access.....	67
Automatic Dimming Mirror.....	102	Autolock.....	69
Manual Dimming Mirror.....	101	Battery Saver.....	70
Introduction.....	7	Illuminated Entry.....	69
<b>J</b>		Power Door Locks.....	67
Jump Starting the Vehicle.....	305	Remote Control.....	67
Connecting the Jumper Cables.....	305	Smart Unlock.....	68
Jump Starting.....	306	Smart Unlocks for Intelligent Access Keys.....	68
Preparing Your Vehicle.....	305	Lug Nuts	
		See: Changing a Road Wheel.....	408
		<b>M</b>	
		Maintenance.....	328
		General Information.....	328

# Index

Manual Climate Control.....	146
Manual Seats.....	156
Manual Lumbar .....	157
Moving the Seat Backward and Forward.....	157
Recline Adjustment.....	157
Memory Function.....	159
Easy Entry and Exit Feature.....	160
Linking a PreSet Position to your Remote Control or Intelligent Access Key Fob .....	160
Recalling a Preset Position.....	160
Saving a Preset Position.....	160
Message Center	
See: Information Displays.....	113
Mirrors	
See: Windows and Mirrors.....	98
Mobile Communications Equipment.....	14
Moonroof.....	103
Bounce-Back.....	104
Opening and Closing the Moonroof.....	103
Motorcraft Parts - 6.2L.....	422
Motorcraft Parts - 6.7L Diesel.....	423
Motorcraft Parts - 6.8L.....	424
MyKey Troubleshooting.....	65
MyKey™.....	63
Principle of Operation.....	63

## N

Navigation.....	535
cityseeker.....	542
Destination Mode.....	537
Map Mode.....	536
Navigation Map Updates.....	543
Navigation Menu.....	540
SiriusXM Traffic and Travel Link.....	543
SYNC AppLink.....	542
Waypoints.....	541
Normal Scheduled Maintenance.....	584
Diesel Engine.....	586
Gasoline Engine.....	585

## O

Oil Change Indicator Reset.....	337
---------------------------------	-----

Oil Check	
See: Engine Oil Check - 6.2L/6.8L.....	333
See: Engine Oil Check - 6.7L Diesel.....	334
Opening and Closing the Hood.....	328
Ordering Additional Owner's Literature.....	314
Obtaining a French Owner's Manual.....	315
Overhead Console.....	172

## P

Parking Aids.....	235
Principle of Operation.....	235
Parking Brake.....	227
Passive Anti-Theft System.....	76
SecuriLock®.....	76
PATS	
See: Passive Anti-Theft System.....	76
Pedals.....	86
Perchlorate.....	12
Phone.....	529
During a Phone Call.....	533
Making Calls.....	532
Pairing Your Cell Phone for the First Time.....	529
Phone Menu.....	530
Receiving Calls.....	533
Smartphone Connectivity.....	534
Text Messaging.....	534
Post-Crash Alert System.....	307
Power Door Locks	
See: Locking and Unlocking.....	67
Power Running Boards.....	80
Power Seats.....	157
Multi-Contour Front Seats With Active Motion .....	158
Power Lumbar.....	158
Power Steering Fluid Check.....	350
Power Take-Off.....	213
Power Windows.....	98
Accessory Delay.....	99
Bounce-Back.....	98
One-Touch Up or Down.....	98
Window Lock.....	99
Protecting the Environment.....	16
Puncture	
See: Changing a Road Wheel.....	408

# Index

## R

Rear Axle.....	223
Rear Parking Aid.....	235
Obstacle Distance Indicator.....	236
Rear Seat Armrest.....	165
Rear Seats.....	161
Folding Up the Rear Seat Cushion .....	161
Rear Under Seat Storage.....	161
Returning the Seat to the Seating Position.....	161
Rear View Camera.....	236
Camera Guidelines.....	237
Obstacle Distance Indicator.....	238
Rear Camera Delay.....	238
Using the Rear View Camera System.....	237
Rear View Camera See: Rear View Camera.....	236
Recommended Towing Weights.....	282
Calculating the Maximum Loaded Trailer Weight for Your Vehicle.....	285
Refueling - Diesel.....	191
Dual Fuel Tanks.....	193
Fueling Tips.....	192
Refueling.....	192
Refueling - Gasoline.....	190
Fuel Filler Cap.....	191
Remote Control.....	56
Car Finder.....	61
Integrated Keyhead Transmitter.....	56
Intelligent Access Key.....	57
Memory Feature.....	60
Remote Start.....	61
Replacing the Battery.....	58
Sounding the Panic Alarm.....	61
Remote Start.....	152
Automatic Settings.....	152
Removing the Tailgate.....	72
Repairing Minor Paint Damage.....	377
Replacement Parts.....	
Recommendation.....	12
Collision Repairs.....	13
Scheduled Maintenance and Mechanical Repairs.....	13
Warranty on Replacement Parts.....	13
Replacing a Lost Key or Remote Control.....	62

Reporting Safety Defects (Canada Only).....	315
Reporting Safety Defects (U.S. Only).....	315
Roadside Assistance.....	303
Vehicles Sold in Canada: Getting Roadside Assistance.....	304
Vehicles Sold in Canada: Roadside Assistance Program Coverage.....	304
Vehicles Sold in Canada: Using Roadside Assistance.....	304
Vehicles Sold in the United States: Getting Roadside Assistance.....	303
Vehicles Sold in the United States: Using Roadside Assistance.....	303
Roadside Emergencies.....	303
Running-In See: Breaking-In.....	298
Running Out of Fuel.....	190

## S

Safety Canopy™.....	53
Safety Precautions.....	185
Satellite Radio.....	456
Satellite Radio Electronic Serial Number (ESN).....	457
Satellite Radio Reception Factors.....	457
SiriusXM Satellite Radio Service.....	457
Troubleshooting.....	458
Scheduled Maintenance Record.....	598
Scheduled Maintenance.....	581
Seatbelt Extension.....	45
Seatbelt Height Adjustment.....	42
Seatbelt Reminder.....	43
Belt-Minder™.....	43
Seatbelts.....	37
Principle of Operation.....	37
Seatbelt Warning Lamp and Indicator Chime.....	42
Conditions of operation.....	43
Seats.....	154
Security.....	76
Selective Catalytic Reductant System - Diesel.....	198
Contaminated Diesel Exhaust Fluid or Inoperative Selective Catalytic Reduction System.....	202



# Index

Diesel Exhaust Fluid Guidelines and Information.....	201
Diesel Exhaust Fluid Level.....	198
Diesel Exhaust Fluid Warning Messages and Vehicle Operations.....	200
Filling the Diesel Exhaust Fluid Tank.....	198
Settings.....	546
911 Assist.....	551
Ambient Lighting.....	558
Bluetooth.....	548
Clock.....	548
Display.....	559
General.....	556
Media Player.....	547
Mobile Apps.....	554
Navigation.....	552
Phone.....	548
Radio.....	551
Sound.....	546
Valet Mode.....	560
Vehicle.....	558
Voice Control.....	559
Wi-Fi & Hotspot.....	556
Side Airbags.....	52
Sitting in the Correct Position.....	154
Sliding Windows.....	102
Power Sliding Back Window.....	102
Snow Chains	
See: Using Snow Chains.....	400
Snowplowing.....	300
Engine temperature while plowing.....	301
Installing the Snowplow.....	300
Operating the Vehicle with the Snowplow Attached.....	301
Snowplowing with your Airbag Equipped Vehicle.....	301
Transmission operation while plowing.....	302
Spare Wheel	
See: Changing a Road Wheel.....	408
Special Notices.....	13
New Vehicle Limited Warranty.....	13
On Board Diagnostics Data Link Connector.....	13
Special Instructions.....	13
Using a Slide-In Camper.....	14
Using your Vehicle as an Ambulance.....	14
Using your Vehicle as a Stationary Power Source.....	14
Using your Vehicle With a Snowplow.....	14
Special Operating Conditions Scheduled Maintenance.....	589
Diesel Engine.....	592
Exceptions.....	597
Gasoline Engine.....	589
Speed Control	
See: Cruise Control.....	243
Spot Lamps.....	93
Cargo and Trailer Hookup Lamps.....	94
Stability Control.....	230
Principle of Operation.....	230
Starter Switch	
See: Ignition Switch.....	175
Starting a Diesel Engine - 6.7L	
Diesel.....	178
.....	178
Automatic Engine Shutdown.....	180
Cold Weather Operation.....	180
Cold Weather Starting.....	180
Diesel Engine Fast Start Glow Plug System.....	179
Vehicles with an Ignition Key.....	179
Vehicles with Keyless Start.....	179
Starting a Gasoline Engine - 6.2L/6.8L.....	176
Automatic Engine Shutdown.....	177
Cold Weather Starting (Flexible Fuel Vehicles Only).....	178
Failure to Start.....	177
Guarding Against Exhaust Fumes.....	178
Important Ventilating Information.....	178
Stopping the Engine When Your Vehicle is Moving.....	177
Stopping the Engine When Your Vehicle is Stationary.....	177
Vehicles with an Ignition Key.....	176
Vehicles with Keyless Start.....	177
Starting and Stopping the Engine.....	175
General Information.....	175
Steering.....	259
Adaptive Steering.....	260
Power Steering.....	259
Steering Wheel.....	82
Storage Compartments.....	172

# Index

Sunroof	
See: Moonroof.....	103
Sun Visors.....	102
Illuminated Vanity Mirror.....	103
Supplementary Restraints System.....	46
Principle of Operation.....	46
Switching Off the Engine - 6.7L	
Diesel.....	183
Symbols Glossary.....	8
SYNC™ 3.....	498
General Information.....	498
SYNC™ 3 Troubleshooting.....	560
SYNC™ Applications and	
Services.....	476
911 Assist.....	476
SYNC Mobile Apps.....	478
SYNC™.....	460
General Information.....	460
SYNC™ Troubleshooting.....	490
<b>T</b>	
Tailgate Lock.....	72
Tailgate Step.....	73
Closing the Step.....	74
Opening the Step.....	73
Tailgate.....	72
Technical Specifications	
See: Capacities and Specifications.....	420
Terrain Control.....	233
Principle of Operation.....	233
The Better Business Bureau (BBB) Auto	
Line Program (U.S. Only).....	312
Tire Care.....	382
Glossary of Tire Terminology.....	384
Information About Uniform Tire Quality	
Grading.....	382
Information Contained on the Tire	
Sidewall.....	385
Temperature A B C.....	383
Traction AA A B C.....	383
Treadwear.....	383
Tire Pressure Monitoring System.....	400
Trailer Tire Pressure Monitoring	
System.....	407
Vehicle Tire Pressure Monitoring	
System.....	400
Tires	
See: Wheels and Tires.....	380
Towing a Trailer.....	272
Load Placement.....	273
Towing Points.....	308
Towing the Vehicle on Four	
Wheels.....	295
Emergency Towing.....	295
Recreational Towing.....	295
Towing.....	272
Traction Control.....	229
Principle of Operation.....	229
Trailer Reversing Aids.....	274
Principle of Operation.....	274
Setting Up Trailer Reverse Guidance.....	274
Trailer Reverse Guidance.....	274
Troubleshooting.....	278
Using Trailer Reverse Guidance.....	277
Trailer Sway Control.....	281
Transfer Case Fluid Check.....	349
Transmission Code Designation.....	426
Transmission.....	208
Transporting the Vehicle.....	307
Type Approvals.....	637
RF Certification Logos for Blind Spot	
Information System.....	643
RF Certification Logos for Mid Range	
Radar.....	639
RF Certification Logos for Passive	
Anti-Theft System.....	640
RF Certification Logos for Radio Transceiver	
Module.....	642
RF Certification Logos for Tire Pressure	
Monitoring Sensor(s).....	637
<b>U</b>	
Under Hood Overview - 6.2L.....	329
Under Hood Overview - 6.7L	
Diesel.....	330
F-Super Duty.....	330
Scheduled Maintenance.....	331
Under Hood Overview - 6.8L.....	331
Under Seat Storage.....	172
Rear Under Seat Storage.....	172
Universal Garage Door Opener.....	166
HomeLink Wireless Control System.....	166
USB Port.....	459

# Index

Using Adaptive Cruise Control.....	244	Using Stability Control.....	231
Automatic Cancellation.....	247	AdvanceTrac® with Roll Stability Control™ (RSC®).....	231
Blocked Sensor.....	248	Using SYNC™ With Your Media Player.....	481
Canceling the Set Speed.....	247	Accessing Your USB Song Library.....	485
Changing the Set Speed.....	247	Bluetooth Devices and System Settings.....	487
Detection Issues.....	247	Connecting Your Digital Media Player to the USB Port.....	481
Following a Vehicle.....	245	Media Menu Features.....	484
Hilly Condition and Trailer Tow Usage.....	247	Media Voice Commands.....	482
Overriding the Set Speed.....	246	USB 2.....	487
Resuming the Set Speed.....	247	Voice Commands for Audio Sources.....	488
Setting the Adaptive Cruise Speed.....	245	Using SYNC™ With Your Phone.....	464
Setting the Gap Distance.....	246	Accessing Features through the Phone Menu.....	469
Switching Adaptive Cruise Control Off.....	247	Accessing Your Phone Settings.....	472
Switching Adaptive Cruise Control On.....	244	Bluetooth Devices.....	473
Switching to Normal Cruise Control.....	249	Making Calls.....	468
System Not Available.....	248	Pairing a Phone for the First Time.....	465
Using Cruise Control.....	243	Pairing Subsequent Phones.....	466
Switching Cruise Control Off.....	243	Phone Options during an Active Call.....	468
Switching Cruise Control On.....	243	Phone Voice Commands.....	466
Using Four-Wheel Drive.....	214	Receiving Calls.....	468
4WD Indicator Lights.....	215	System Settings.....	474
Driving Off-Road With Truck and Utility Vehicles.....	218	Text Messaging.....	470
Electronic Shift-On-the-Fly (ESOF) 4WD system.....	214	Using Traction Control.....	229
How Your Vehicle Differs From Other Vehicles.....	218	Switching the System Off.....	229
Manual Shift On Stop (MSOS) 4WD system.....	214	System Indicator Lights and Messages.....	229
Using a Manual Shift On Stop (MSOS) 4WD system.....	215	Using Voice Recognition.....	462
Using the Electronic Shift on the Fly 4WD system.....	217	Audio Voice Commands.....	511
Using Hill Descent Control.....	233	Climate Voice Commands.....	512
Hill descent modes.....	233	Initiating a Voice Session.....	462
Using MyKey With Remote Start Systems.....	65	Mobile App Voice Commands.....	515
Using Power Running Boards.....	80	Navigation Voice Commands.....	514
Automatic Power Deploy.....	80	Phone Voice Commands.....	512
Automatic Power Stow.....	80	SiriusXM Traffic and Travel Link Voice Commands.....	515
Bounce-back.....	81	System Interaction and Feedback.....	463
Enabling and Disabling.....	81	Voice Settings Commands.....	516
Manual Power Deploy.....	80	Utilizing the Mediation/Arbitration Program (Canada Only).....	313
Using Snow Chains.....	400		

# Index

## V

Vehicle Care.....	370
General Information.....	370
Vehicle Certification Label.....	426
Vehicle Identification Number.....	425
Vehicle Storage.....	377
Battery.....	378
Body.....	377
Brakes.....	378
Cooling system.....	378
Engine.....	378
Fuel system.....	378
General.....	377
Miscellaneous.....	378
Removing Vehicle From Storage.....	378
Tires.....	378
Ventilation	
See: Climate Control.....	146
VIN	
See: Vehicle Identification Number.....	425
Voice Control.....	84

## W

Warning Lamps and Indicators.....	108
4X2.....	111
4X4 HIGH.....	112
4X4 LOW.....	111
Adaptive Cruise Control.....	108
Adaptive Steering.....	108
Anti-Lock Braking System.....	109
Automatic High Beam.....	109
Battery.....	109
Blind Spot Monitor.....	109
Brake System.....	109
Check Fuel Cap.....	109
Cruise Control.....	110
Diesel Engine Brake.....	112
Diesel Exhaust Fluid.....	112
Direction Indicator.....	110
Door Ajar.....	110
Electronic Locking Differential.....	110
Engine Coolant Temperature.....	110
Engine Oil.....	110
Fasten Seatbelt.....	110
Front Airbag.....	110
Front Fog Lamps.....	110

High Beam.....	110
Hill Descent.....	110
Low Fuel Level.....	110
Low Tire Pressure Warning.....	110
Powertrain Malfunction/Reduced Power/Electronic Throttle Control.....	111
Service Engine Soon.....	111
Stability Control.....	111
Stability Control Off.....	111
Transmission Tow/Haul.....	111
Wait To Start.....	112
Water In Fuel.....	112
Washer Fluid Check.....	350
Washers	
See: Cleaning the Exterior.....	370
See: Wipers and Washers.....	87
Waxing.....	371
Wheel Nuts	
See: Changing a Road Wheel.....	408
Wheels and Tires.....	380
General Information.....	380
Technical Specifications.....	418
Windows and Mirrors.....	98
Windshield Washers.....	88
Windshield Wipers.....	87
Speed Dependent Wipers.....	87
Wiper Blades	
See: Checking the Wiper Blades.....	355
Wipers and Washers.....	87